

Nikon

DIGITAL CAMERA
COOLPIX S80

User's Manual

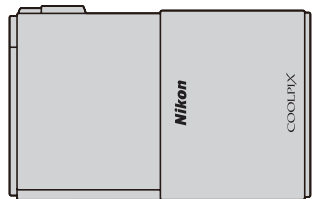

En

Trademark Information

- Microsoft, Windows and Windows Vista are either registered trademarks or trademarks of Microsoft Corporation in the United States and/or other countries.
- Macintosh, Mac OS, and QuickTime are trademarks of Apple Inc.
- Adobe and Acrobat are registered trademarks of Adobe Systems Inc.
- SDXC, SDHC, and SD Logos are trademarks of SD-3C, LLC.
- PictBridge is a trademark.
- HDMI, **HDMI** logo, and High-Definition Multimedia Interface are trademarks or registered trademarks of HDMI Licensing LLC.
- ACCESS and NetFront are registered trademarks or trademarks of ACCESS Co., LTD in Japan, the United States and/or other countries. **NetFront**
- All other trade names mentioned in this manual or the other documentation provided with your Nikon product are trademarks or registered trademarks of their respective holders.

AVC Patent Portfolio License

This product is licensed under the AVC Patent Portfolio License for the personal and non-commercial use of a consumer to (i) encode video in compliance with the AVC standard ("AVC video") and/or (ii) decode AVC video that was encoded by a consumer engaged in a personal and non-commercial activity and/or was obtained from a video provider licensed to provide AVC video. No license is granted or shall be implied for any other use. Additional information may be obtained from MPEG LA, L.L.C.

See <http://www.mpegla.com>.

Introduction

First Steps

Basic Photography and Playback:  (Easy Auto) Mode

More on Shooting

More on Playback

Editing Pictures

Movie Recording and Playback

Connecting to Televisions, Computers and Printers

Basic Camera Setup

Caring for the Camera

Technical Notes and Index

For Your Safety

To prevent damage to your Nikon product or injury to yourself or to others, read the following safety precautions in their entirety before using this equipment. Keep these safety instructions where all those who use the product will read them. The consequences that could result from failure to observe the precautions listed in this section are indicated by the following symbol:



This icon marks warnings, information that should be read before using this Nikon product, to prevent possible injury.

WARNINGS

Turn off in the event of malfunction

Should you notice smoke or an unusual smell coming from the camera or AC adapter, unplug the AC adapter and remove the battery immediately, taking care to avoid burns. Continued operation could result in injury. After removing or disconnecting the power source, take the equipment to a Nikon-authorized service representative for inspection.

Do not disassemble

Touching the internal parts of the camera or AC adapter could result in injury. Repairs should be performed only by qualified technicians. Should the camera or AC adapter break open as the result of a fall or other accident, take the product to a Nikon-authorized service representative for inspection, after unplugging the product and/or removing the battery.

Do not use the camera or AC adapter in the presence of flammable gas

Do not use electronic equipment in the presence of flammable gas, as this could result in explosion or fire.

Handle the camera strap with care

Never place the strap around the neck of an infant or child.

Keep out of reach of children

Particular care should be taken to prevent infants from putting the battery or other small parts into their mouths.

 Observe caution when handling the battery

The battery may leak or explode if improperly handled. Observe the following precautions when handling the battery for use in this product:

- Before replacing the battery, turn the product off. If you are using the AC adapter (available separately), be sure to unplug the AC adapter from an electrical outlet.
- Use only a Rechargeable Li-ion Battery EN-EL10 (supplied). Charge the battery inserted into the camera by connecting the Charging AC Adapter EH-68P/EH-68P (AR) (supplied).
- When inserting the battery, do not attempt to insert it upside down or backwards.
- Do not short or disassemble the battery or attempt to remove or break the battery insulation or casing.
- Do not expose the battery to flame or to excessive heat.
- Do not immerse in or expose to water.
- Return the battery to the battery case for transportation. Do not transport or store with metal objects such as necklaces or hairpins.
- The battery is prone to leakage when fully discharged. To avoid damage to the product, be sure to remove the battery when no charge remains.

 Observe the following precautions when handling the Charging AC Adapter

- Discontinue use immediately should you notice any change in the battery, such as discoloration or deformation.
- If liquid from the damaged battery comes in contact with clothing or skin, rinse immediately with plenty of water.
- Keep dry. Failure to observe this precaution could result in fire or electric shock.
- Dust on or near the metal parts of the plug should be removed with a dry cloth. Continued use could result in fire.
- Do not handle the cable or go near the Charging AC Adapter during lightning storms. Failure to observe this precaution could result in electric shock.
- Do not damage, modify, forcibly tug or bend the cable, place it under heavy objects, or expose it to heat or flames. Should the insulation be damaged and the wires become exposed, take it to a Nikon-authorized service representative for inspection. Failure to observe these precautions could result in fire or electric shock.

For Your Safety

- Do not handle the plug or Charging AC Adapter with wet hands. Failure to observe this precaution could result in electric shock.
- Do not use with travel converters or adapters designed to convert from one voltage to another or with DC-to-AC inverters. Failure to observe this precaution could damage the product or cause overheating or fire.

Use appropriate cables

When connecting cables to the input and output jacks, use only the cables provided or sold by Nikon for the purpose, to maintain compliance with product regulations.

Handle moving parts with care

Be careful that your fingers or other objects are not pinched by the slide cover or other moving parts.

CD-ROMs

The CD-ROMs supplied with this device should not be played back on audio CD equipment. Playing CD-ROMs on an audio CD player could cause hearing loss or damage the equipment.

Observe caution when using the flash

Using the flash close to your subject's eyes could cause temporary visual impairment. Particular care should be observed if photographing infants, when the flash should be no less than one meter (3 ft. 4 in.) from the subject.

Do not operate the flash with the flash window touching a person or object

Failure to observe this precaution could result in burns or fire.

Do not apply pressure to the monitor

Should the monitor break, care should be taken to avoid injury caused by broken glass.

Turn the power off when using inside an airplane or the hospital

Turn the power off while inside the airplane during take off or landing. Follow the instructions of the hospital when using while in a hospital. The electromagnetic waves given out by this camera may disrupt the electronic systems of the airplane or the instruments of the hospital.

Notices

Notices for Customers in the U.S.A.

IMPORTANT SAFETY INSTRUCTIONS— SAVE THESE INSTRUCTIONS.

DANGER - TO REDUCE THE RISK OF FIRE OR ELECTRIC SHOCK, CAREFULLY FOLLOW THESE INSTRUCTIONS

For connection to a supply not in the U.S.A., use an attachment plug adapter of the proper configuration for the power outlet if needed.

The power supply unit is intended to be correctly orientated in a vertical or floor mount position.

Federal Communications Commission (FCC) Radio Frequency Interference Statement

This equipment has been tested and found to comply with the limits for a Class B digital device, pursuant to Part 15 of the FCC rules. These limits are designed to provide reasonable protection against harmful interference in a residential installation. This equipment generates, uses, and can radiate radio frequency energy and, if not installed and used in accordance with the instructions, may cause harmful interference to radio communications. However, there is no guarantee that interference will not occur in a particular installation. If this equipment does cause harmful interference to radio or television reception, which can be determined by turning the equipment off and on, the user is encouraged to try to correct the interference by one or more of the following measures:

- Reorient or relocate the receiving antenna.

- Increase the separation between the equipment and receiver.
- Connect the equipment into an outlet on a circuit different from that to which the receiver is connected.
- Consult the dealer or an experienced radio/television technician for help.



Nikon
COOLPIX S80

CAUTIONS

Modifications

The FCC requires the user to be notified that any changes or modifications made to this device that are not expressly approved by Nikon Corporation may void the user's authority to operate the equipment.

Interface Cables

Use the interface cables sold or provided by Nikon for your equipment. Using other interface cables may exceed the limits of Class B Part 15 of the FCC rules.

Notice for customers in the State of California

WARNING

Handling the cord on this product will expose you to lead, a chemical known to the State of California to cause birth defects or other reproductive harm.

Wash hands after handling.

Nikon Inc.,
1300 Walt Whitman Road
Melville, New York 11747-3064
USA

Tel: 631-547-4200

Notice for customers in Canada

CAUTION

This Class B digital apparatus complies with Canadian ICES-003.

ATTENTION

Cet appareil numérique de la classe B est conforme à la norme NMB-003 du Canada.

Notices for customers in Europe

CAUTION

RISK OF EXPLOSION IF BATTERY IS REPLACED BY AN INCORRECT TYPE.

DISPOSE OF USED BATTERIES ACCORDING TO THE INSTRUCTIONS.

This symbol indicates that this product is to be collected separately.



The following apply only to users in European countries:

- This product is designated for separate collection at an appropriate collection point. Do not dispose of as household waste.
- For more information, contact the retailer or the local authorities in charge of waste management.

This symbol on the battery indicates that the battery is to be collected separately.



The following apply only to users in European countries:

- All batteries, whether marked with this symbol or not, are designated for separate collection at an

appropriate collection point. Do not dispose of as household waste.

- For more information, contact the retailer or the local authorities in charge of waste management.

Table of Contents

















For Your Safety	ii
WARNINGS	ii
Notices	v
Introduction	1
About This Manual	1
Information and Precautions	2
Parts of the Camera	4
The Camera Body	4
Attaching the Camera Strap	4
Shutter-Release Button	5
Operating the Touch Panel	6
Tapping	6
Dragging	6
Dragging and Dropping	7
Spreading/pinching	7
Main Display of the Monitor/Touch Panel and Basic Operations	8
Shooting (Information Indicators)	8
Shooting (Operation Controls)	9
Playback (Information Display)	10
Playback (Operation Controls)	11
Opening the Tabs	12
First Steps	14
Inserting the Battery	14
Removing the Battery	15
Charging the Battery	16
Turning On and Off the Camera	19
Setting Display Language, Date and Time	20
Inserting Memory Cards	22
Removing Memory Cards	22
Basic Photography and Playback:  (Easy Auto) Mode	24
Step 1 Turn the Camera On and Select  Easy Auto Mode	24
Indicators Displayed in  (Easy Auto) Mode	25
Step 2 Frame a Picture	26
Using the Zoom	27
Step 3 Focus and Shoot	28
Step 4 Playing Back and Deleting Pictures	30
Playing Back Pictures (Playback Mode)	30
Deleting Unwanted Pictures	31
Basic Shooting Functions	32
 Using the Flash	33
 Taking Pictures with the Self-timer	36

Table of Contents

 Image Mode (Image Quality/Image Size)	38
 Tapping the Monitor to Release the Shutter (Touch Shutter)	41
 Tapping the Monitor to Focus (Touch AF/AE)	44
 Changing Brightness Using Exposure Compensation	47
<hr/>	
More on Shooting	48
Selecting a Shooting Mode	48
 (Easy Auto) Mode	49
Shooting in  (Auto) Mode	51
Adjusting the  (Auto) Mode Setting	53
 Macro Mode Setting	54
 Subject Tracking (Focusing on a Moving Subject)	55
ISO ISO Sensitivity	57
 Continuous	58
WB White Balance (Adjusting Hue)	59
Shooting Suited to Scenes (Scene Mode)	61
Selecting a Scene Mode	61
Selecting a Scene Mode to Take Pictures (Features)	64
Shooting for a Panorama	70
Shooting Smiling Faces (Smart Portrait Mode)	72
Changing the Smart Portrait Mode Settings	74
Camera Settings That cannot be Applied Simultaneously	76
<hr/>	
More on Playback	78
Operations in Full-frame Playback Mode	78
Viewing Multiple Pictures: Thumbnail Playback	79
Taking a Closer Look: Playback Zoom	81
Selecting Playback Mode	83
Sorting Favorite Pictures (Favorite Pictures Mode)	84
Adding Pictures to Albums	84
Viewing Pictures in an Album	86
Removing Pictures from Albums	87
Operations in Favorite Pictures Mode	88
Changing Icons Assigned to Albums	89
Finding Pictures in Auto Sort Mode	91
Viewing Pictures in Auto Sort Mode	91
Operations in Auto Sort Mode	93
Selecting Pictures Taken on a Specific Day (List by Date Mode)	94
Selecting a Date in List by Date Mode	94
Operations in List by Date Mode	95
Playback Options	96
Setting the Picture Rating	97
Playing Back Pictures by Rating	97
 Enjoying Slide Shows	98































 Protecting Important Pictures (Protect)	100
Protecting One Picture.....	100
Protecting Multiple Pictures	101
Removing Protection from Pictures.....	101
 Creating a DPOF Print Order: Print Set	102
Creating a Print Order for One Picture	102
Creating a Print Order for Multiple Pictures	104
Canceling Print Order.....	105
 Rotate Image	106
 Voice Memo: Recording and Playback	107
Recording Voice Memos	107
Playing Voice Memos.....	108
Deleting Voice Memos.....	108
<hr/>	
Editing Pictures	109
Editing Functions	109
Picture Editing	111
 Paint.....	111
 Quick Retouch: Enhancing Contrast and Saturation.....	114
 D-Lighting: Enhancing Brightness and Contrast	115
 Stretch: Stretching Pictures.....	116
 Perspective Control: Adjust a Sense of Perspective.....	117
 Filter Effects (digital filter)	118
 Glamour Retouch.....	120
 Small Picture: Making Smaller Pictures.....	122
 Crop: Creating a Cropped Copy	123
<hr/>	
Movie Recording and Playback	124
Recording Movies	124
Movie Recording Settings.....	126
 Movie Options.....	127
Movie Playback	128
<hr/>	
Connecting to Televisions, Computers and Printers	129
Connecting to a TV	129
Connecting to a Computer	132
Before Connecting the Camera.....	132
Transferring Images from a Camera to a Computer.....	133
Charging While Connecting to a Computer	137
Connecting to a Printer	138
Connecting the Camera to a Printer.....	139
Printing Pictures One at a Time.....	141
Printing Multiple Pictures	142

Table of Contents

Basic Camera Setup	145
The Setup Menu	145
Operating the Setup Menu	146
 Welcome Screen	147
 Date	148
 Monitor Settings	151
 Date Imprint (Imprinting Date and Time)	152
 Vibration Reduction	153
 AF Assist	154
 Digital Zoom	154
 Sound Settings	155
 Auto Off	155
 Format Memory/Format Card	156
 Language	157
 TV Settings	158
 Charge by Computer	159
 Blink Warning	159
 Reset All	161
 Copy (Copy between Internal Memory and Memory Card)	164
 Firmware Version	165
Caring for the Camera.....	166
Maximizing Camera Life and Performance.....	166
Cleaning	168
Storage	168
Technical Notes and Index.....	169
Optional Accessories	169
Approved Memory Cards	170
Image/Sound File and Folder Names	171
Error Messages	172
Troubleshooting.....	177
Specifications	184
Supported Standards	187
Index	188

About This Manual

Thank you for your purchase of a Nikon COOLPIX S80 digital camera. This manual was written to help you enjoy taking pictures with your Nikon digital camera. Read this manual thoroughly before use, and keep it where all those who use the product will read it.

Symbols and Conventions

To make it easier to find the information you need, the following symbols and conventions are used:



This icon marks cautions, information that should be read before use, to prevent damage to the camera.



This icon marks tips, additional information that may be helpful when using the camera.



This icon marks notes, information that should be read before using the camera.



This icon indicates that more information is available elsewhere in this manual.

Notations

- Secure Digital (SD) memory card, SDHC memory card, and SDXC memory card are referred to as “memory card.”
- The setting at the time of purchase is referred to as the “default setting.”
- The names of menu items displayed in the camera monitor, and the names of buttons or messages displayed on a computer monitor appear in bold.

Screen Samples

In this manual, images are sometimes omitted from monitor display samples so that monitor indicators can be more clearly shown.

Illustrations and Screen Display

Illustrations and text displays shown in this manual may differ from actual display.

Internal Memory and Memory Cards

Pictures taken with this camera can be stored in the camera's internal memory or on removable memory cards. If a memory card is inserted, all new pictures will be stored on the memory card and delete, playback and format operations will apply only to the pictures on the memory card. The memory card must be removed before the internal memory can be formatted or accessed for picture storage, deletion, or viewing.

Information and Precautions

Life-Long Learning

As part of Nikon's "Life-Long Learning" commitment to ongoing product support and education, continually updated information is available online at the following sites:

- For users in the U.S.A.: <http://www.nikonusa.com/>
- For users in Europe and Africa: <http://www.europe-nikon.com/support/>
- For users in Asia, Oceania, and the Middle East: <http://www.nikon-asia.com/>

Visit these sites to keep up-to-date with the latest product information, tips, answers to frequently asked questions (FAQs), and general advice on digital imaging and photography. Additional information may be available from the Nikon representative in your area. Visit the site below for contact information.

URL below for contact information:

<http://imaging.nikon.com/>

Use Only Nikon Brand Electronic Accessories

Nikon COOLPIX cameras are designed to the highest standards and include complex electronic circuitry. Only Nikon brand electronic accessories (including battery charger, batteries, Charging AC Adapter and AC adapters) certified by Nikon specifically for use with this Nikon digital camera are engineered and proven to operate within the operational and safety requirements of this electronic circuitry.

THE USE OF NON-NIKON ELECTRONIC ACCESSORIES COULD DAMAGE THE CAMERA AND MAY VOID YOUR NIKON WARRANTY.

The use of third-party rechargeable Li-ion batteries not bearing the Nikon holographic seal could interfere with normal operation of the camera or result in the batteries overheating, igniting, rupturing, or leaking.

For more information about Nikon brand accessories, contact a local authorized Nikon dealer.



Holographic seal:

Identifies this device as an authentic Nikon product.

Before Taking Important Pictures

Before taking pictures on important occasions (such as at weddings or before taking the camera on a trip), take a test shot to ensure that the camera is functioning normally. Nikon will not be held liable for damages or lost profits that may result from product malfunction.

About the Manuals

- No part of the manuals included with this product may be reproduced, transmitted, transcribed, stored in a retrieval system, or translated into any language in any form, by any means, without Nikon's prior written permission.
- Nikon reserves the right to change the specifications of the hardware and software described in these manuals at any time and without prior notice.
- Nikon will not be held liable for any damages resulting from the use of this product.
- While every effort was made to ensure that the information in these manuals is accurate and complete, we would appreciate it were you to bring any errors or omissions to the attention of the Nikon representative in your area (address provided separately).

Notice Concerning Prohibition of Copying or Reproduction

Note that simply being in possession of material that was digitally copied or reproduced by means of a scanner, digital camera or other device may be punishable by law.

- **Items prohibited by law from being copied or reproduced**

Do not copy or reproduce paper money, coins, securities, government bonds or local government bonds, even if such copies or reproductions are stamped "Sample." The copying or reproduction of paper money, coins, or securities which are circulated in a foreign country is prohibited. Unless the prior permission of the government was obtained, the copying or reproduction of unused postage stamps or post cards issued by the government is prohibited. The copying or reproduction of stamps issued by the government and of certified documents stipulated by law is prohibited.

- **Cautions on certain copies and reproductions**

The government has issued cautions on copies or reproductions of securities issued by private companies (shares, bills, checks, gift certificates, etc.), commuter passes or coupon tickets, except when a minimum of necessary copies are to be provided for business use by a company. Also, do not copy or reproduce passports issued by the government, licenses issued by public agencies and private groups, ID cards and tickets, such as passes and meal coupons.

- **Comply with copyright notices**

The copying or reproduction of copyrighted creative works such as books, music, paintings, woodcut prints, maps, drawings, movies and photographs is governed by national and international copyright laws. Do not use this product for the purpose of making illegal copies or to infringe copyright laws.

Disposing of Data Storage Devices

Please note that deleting images or formatting data storage devices such as memory cards or built-in camera memory does not completely erase the original image data. Deleted files can sometimes be recovered from discarded storage devices using commercially available software, potentially resulting in the malicious use of personal image data. Ensuring the privacy of such data is the user's responsibility.

Before discarding a data storage device or transferring ownership to another person, erase all data using commercial deletion software, or format the device and then completely refill it with images containing no private information (for example, pictures of empty sky). Be sure to also replace any pictures selected for the welcome screen (📖 147). Care should be taken to avoid injury or damage to property when physically destroying data storage devices.

Parts of the Camera

The Camera Body

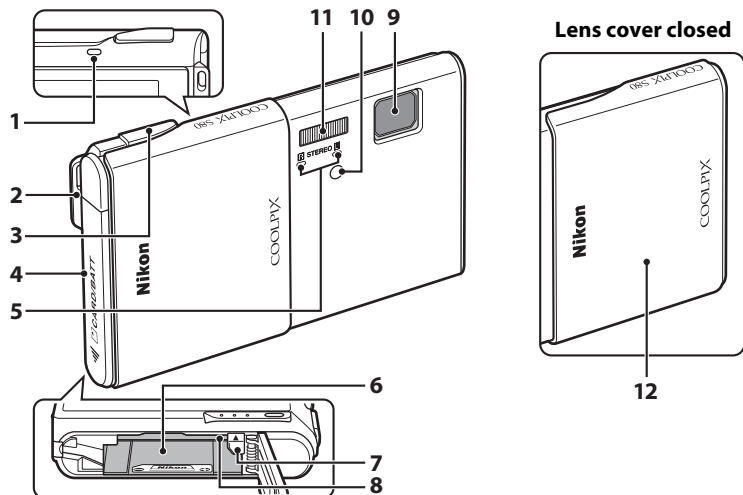

- | | | | |
|--|-------------|---|----------|
| 1 Power-on lamp..... | 17, 19, 137 | 7 Battery latch..... | 14, 15 |
| 2 Eyelet for camera strap..... | 4 | 8 Memory card slot..... | 22 |
| 3 Shutter-release button..... | 28 | 9 Lens..... | 168, 184 |
| 4 Battery-chamber/
memory card slot cover..... | 14, 22 | 10 Self-timer lamp..... | 36, 73 |
| 5 Microphone (stereo)..... | 107, 124 | 11 AF-assist illuminator..... | 29, 154 |
| 6 Battery chamber..... | 14 | 11 Flash..... | 33 |
| | | 12 Slide cover (power switch)..... | 19 |

Attaching the Camera Strap

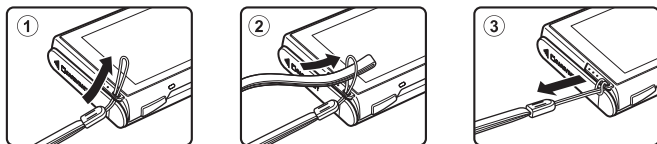

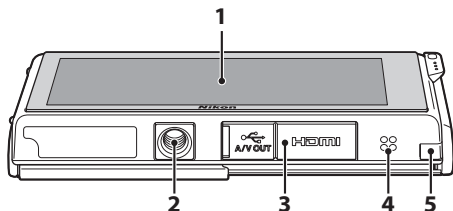

Under the connector cover

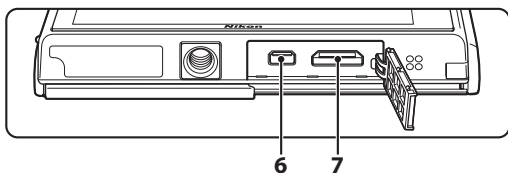

1	OLED monitor (monitor)*/ touch panel.....6	5	Power connector cover (for connection with optional AC Adapter) 169
2	Tripod socket	6	USB/audio/video output connector.....16, 129, 133, 139
3	Connector cover 16, 129, 133, 139	7	HDMI mini connector..... 129
4	Speaker 108, 128		

* Referred to simply as the “monitor” in this manual.

Shutter-Release Button

The camera features a two-stage shutter-release button. To set focus and exposure, press the shutter-release button halfway, stopping when you feel resistance. Focus and exposure lock while the shutter-release button is held in this position. To release the shutter and take a picture, press the shutter-release button the rest of the way down. Do not use force when pressing the shutter-release button, as this may result in camera shake and blurred pictures.



Press the shutter-release button halfway to set focus and exposure.

Press the shutter-release button the rest of the way down to take a picture.

Operating the Touch Panel

The monitor on the COOLPIX S80 is a touch panel display operated by touch. Use the method described below.

Tapping

Tap the touch panel.

Use this operation to:

Select icons or other controls

Select pictures in thumbnail playback mode (📖 79)

Perform touch shutter (📖 41), touch AF/AE (📖 44), or subject tracking (📖 55) operations

Display the setting controls during shooting or playback (📖 12)

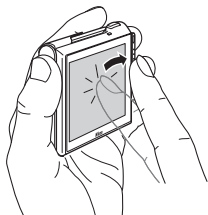

Dragging

Drag your finger across the touch panel and remove it from the touch panel.

Use this operation to:

Scroll through pictures in full-frame playback mode (📖 30)

Move the visible portion of a picture enlarged with playback zoom (📖 81)

Use sliders to adjust exposure compensation (📖 47) or other settings

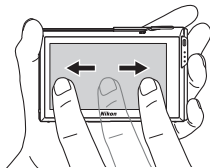

When the camera is in full-frame playback mode, drag two fingers across the touch panel to scroll ahead ten frames quickly.

Place two fingers on the touch panel about 1.5 cm (0.6 in.) apart, slide them about 2 cm (0.8 in.) to left or right. Note that the desired results may not be achieved if your fingers are placed side by side.

Tap the touch panel to stop at the current frame.

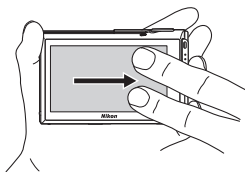

Dragging and Dropping

Place your finger on the touch panel, drag it to the desired location (①), and remove it from the touch panel (②).

Use this operation to:

Apply the rating setting (📖 97)

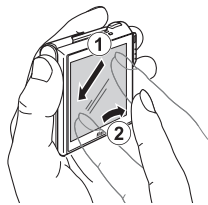

Spreading/pinching

Spread two fingers apart/pinch two fingers together

Use this operation to:

Zoom in/out on a picture (📖 81) in playback mode

Switch to thumbnail playback mode from full-frame playback mode (📖 79)

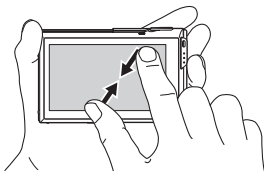
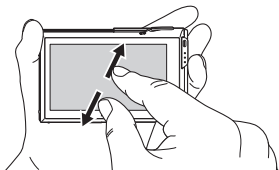

✓ Notes on the Touch Panel

- This camera utilizes a static touch panel. Therefore, it may not respond when touched with fingernails or gloved fingers.
- Do not press on the touch panel with pointed objects.
- Do not apply unnecessary pressure to the touch panel.
- The touch panel may not respond to touch if a commercially available protecting film is applied.

✓ Notes on Touch Panel Operations

- The camera may not respond if your finger is left in one place too long.
- The camera may not respond if the followings are made.
 - Bounce your finger off the display
 - Drag your finger over too short a distance
 - Stroke the display too lightly
 - Move your finger too quickly
 - Change the distance between your fingers while you drag two fingers or drag them too far
 - Both fingers are not moved simultaneously when spreading or pinching

Main Display of the Monitor/Touch Panel and Basic Operations

Shooting (Information Indicators)

The information displayed on the monitor varies with the camera settings or status.

Introduction

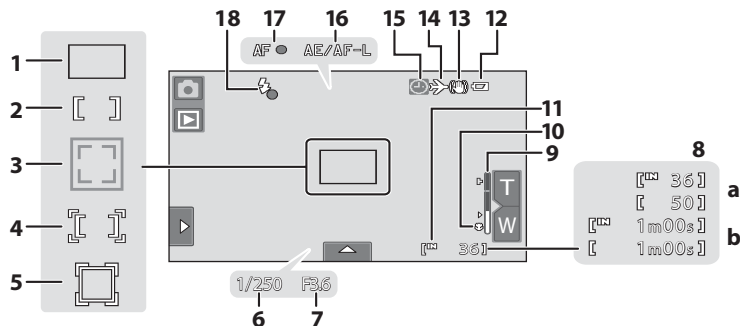

1	Focus area (auto).....	49	11	Internal memory indicator.....	25
2	Focus area (center)		12	Battery level indicator.....	24
3	Focus area (face detection).....	28, 72	13	Vibration reduction.....	153
4	Focus area (touch AF/AE).....	44	14	Travel destination.....	148
5	Focus area (subject tracking).....	55	15	Date not set.....	172
6	Shutter speed.....	28		Date imprint.....	152
7	Aperture.....	28	16	AE/AF-L indicator.....	71
8	a Number of exposures remaining (still pictures)*.....	24	17	Focus indicator.....	28
	b Movie recording time remaining	127	18	Flash indicator.....	34
9	Zoom indicator.....	27, 54			
10	Macro mode.....	54			

* Indicator is displayed when there are 50 or fewer exposures remaining.

Auto Monitor Boost

The camera automatically increases monitor brightness outdoors and under extremely bright lighting to make the monitor display easier to see and read (when **Brightness** (151) in the setup menu (145) is set to **4** or less).

Shooting (Operation Controls)

Tap the following controls to change settings.

- Tap the tab to display the setting controls and shooting settings can be changed (📖 12).
- The controls available and the setting status displayed vary depending upon the shooting mode and the current camera settings.

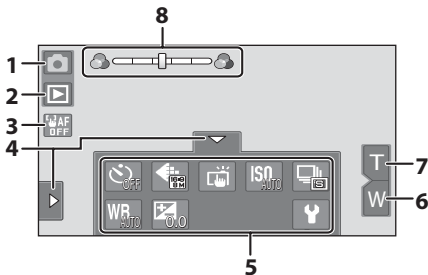

1	Shooting mode*	24, 51, 61, 72, 124	5	Setting controls	13
2	Switch to playback mode	30	6	Wide zoom	27
3	Touch AF/AE cancellation.....	44	7	Tele zoom.....	27
4	Tab.....	12	8	Scene effect adjustment slider	63

* Indicators displayed vary with current shooting mode.

📎 Monitor Display in Portrait (“Tall”) Orientation

When the camera is held in portrait (“tall”) orientation, the controls and indicators are also displayed in portrait (“tall”) orientation. Controls and indicators may not be appropriately rotated when the camera is pointing up or down.

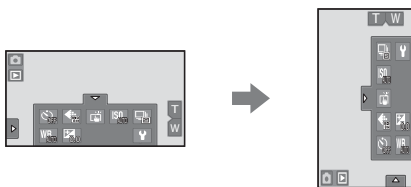

Playback (Information Display)

The following monitor display shows information for the picture currently displayed and camera status.

- The information displayed on the monitor varies with the camera settings or status.
- The indicators below are displayed when the camera is turned on or is in operation, and they disappear after a few seconds elapse (📖 151).

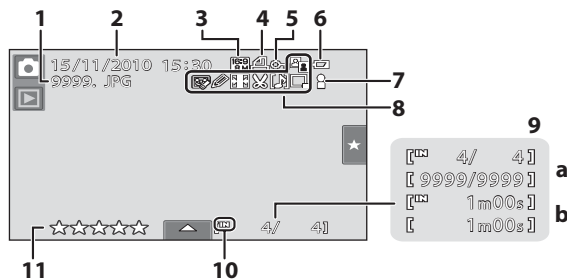

1	File number and type 171	8	Glamour retouch icon 120
2	Date/time of recording..... 20		Filter effects icon 118
3	<div style="display: flex; justify-content: space-around; font-size: small;"> 14M 14M 8M 5M 3M PC VGA 8M 2M </div> Image mode ¹ 38, 112, 122, 123 <div style="display: flex; justify-content: space-around; font-size: x-small;"> HD 720 VGA QVGA </div> Movie options ¹ 127		Quick retouch icon 114
4	Print-order icon 102		D-Lighting icon 115
5	Protect icon 100		Paint icon 111
6	Battery level indicator 24		Stretch icon 116
7	Album icon in favorite pictures mode ² 86 Category icon in auto sort mode ² 91		Perspective control icon 117
			Voice memo icon 107
			Small picture icon 122
			Crop icon 123
		a	Current frame number/ total number of frames 30
		b	Movie length 128
		10	Internal memory indicator 30
		11	Rating indicator 97

¹ Indicators displayed vary depending on the setting for shooting.

² The icon for the selected album or category in auto sort mode currently selected in playback mode is displayed.

Playback (Operation Controls)

Tap the following controls to change settings.

- Tap the tab to display the setting controls (📖 12) and deleting or editing will be available.
- The controls available displayed vary depending upon the displayed picture and the current camera settings.

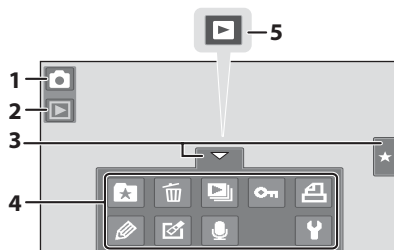

1	Switch to shooting mode ¹24, 51, 61, 72, 124	3	Tab..... 12
2	Playback mode ²30, 84, 91, 94	4	Setting controls..... 13
		5	Movie playback..... 128

¹ Indicators displayed vary with the shooting mode.

² Indicators displayed vary with current playback mode.



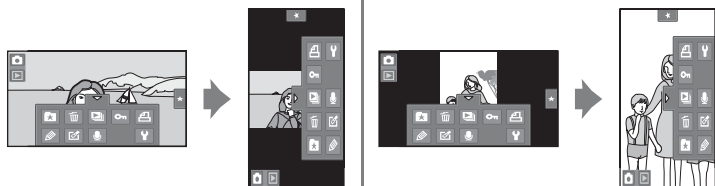

Picture Display

When the camera is rotated, the picture and controls displayed are also rotated as indicated below. Pictures and controls may not be appropriately rotated when the camera is pointing up or down.



Opening the Tabs

When in shooting or playback mode, use the setting controls to make shooting and playback settings. Display the controls by tapping the tab at the bottom, left or right side of the monitor.

- Tap the icon of the desired item to display the setting screen for that item.
- Tap  (setup) in the setting controls to make the basic camera settings.
- When  or  is displayed on the setting screen, tap  to exit the setting screen and tap  to return to the previous screen.
- Tap the tab again to hide the setting controls.

Tap the tab to display the icons of settings that can be changed in the current mode.

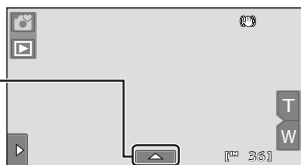

To hide setting controls, tap the tab again.

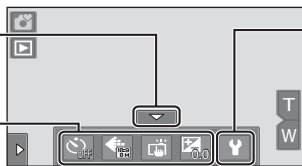

Tap  to display the setup menu.

Tap an icon to display the setting screen of that item.

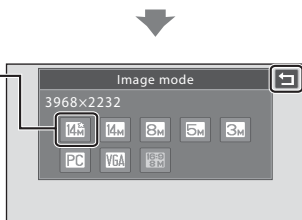

Tap an icon to apply the setting of that item.

Return to the previous screen.

Shooting

Shooting settings can be made.

- The available setting items vary depending on the shooting mode (48).
- Each icon also indicates the current setting.

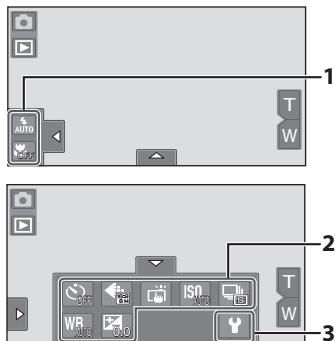

1	Flash mode.....33	
	Macro mode.....54	
2	Self-timer.....36	
	Image mode.....38	
	Touch shooting	
	Touch shutter.....41	
	Touch AF/AE.....44	
	Subject tracking.....55	
	ISO sensitivity.....57	
3	Continuous.....58	
	White balance.....59	
	Exposure compensation.....47	
	Setup.....145	

Playback

Pictures can be edited and deleted, and playback settings can be made.

- The available setting items vary depending on the type of picture or playback mode.

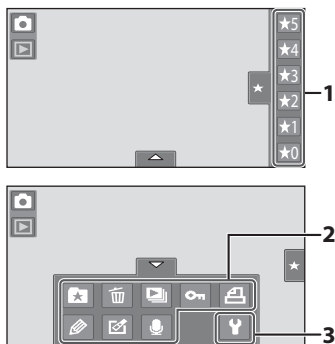

1	Rating.....97
	Add pictures to albums (except in favorite pictures mode) ...84
2	Remove pictures from albums (in favorite pictures mode)87
	Delete31
	Slide show.....98
	Protect.....100
	DPOF print order.....102
	Paint.....111
	Retouch.....109
3	Voice memo.....107
	Setup.....145

Inserting the Battery

Insert a Rechargeable Li-ion Battery EN-EL10 (supplied) into the camera.

- Charge the battery before the first use or when the battery is running low (📖 16).

- 1 Slide the battery-chamber/memory card slot cover in the direction indicated by the arrow (①) and open the cover (②).

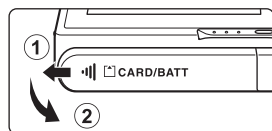

- 2 Insert the battery.

Confirm that the battery's positive (+) and negative (-) terminals are oriented correctly as shown on the label at the battery chamber opening, and insert the battery.

Use the battery to push up the orange battery latch in the direction indicated by the arrow (①) and fully insert the battery (②).

The battery latch will spring back into place when the battery is fully inserted.

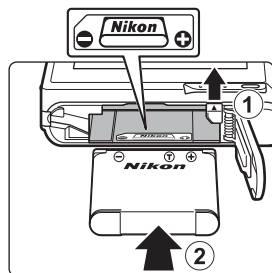

❑ Inserting the Battery

Inserting the battery upside down or backwards could damage the camera. Be sure to check that the battery is in the correct orientation.

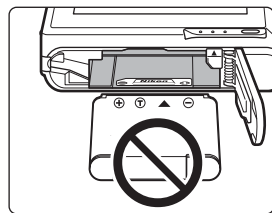

- 3 Close the battery-chamber/memory card slot cover.

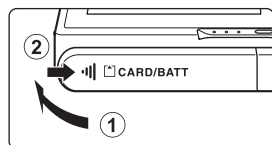

Removing the Battery

Close the slide cover to turn the camera off (📖 19) and be sure that the power-on lamp and the monitor have turned off before opening the battery-chamber/memory card slot cover.

To eject the battery, open the battery-chamber/memory card slot cover and slide the orange battery latch in the direction indicated by the arrow (①). The battery can then be removed by hand (②).

- Note that the battery and memory card may become hot during use; observe due caution when removing the battery.

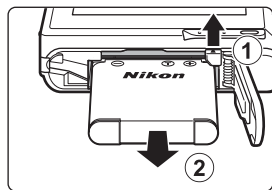

✓ Notes on the Battery

- Be sure to read and follow the warnings for the battery on page iii and the section, “The Battery” (📖 167), before use.
- If the battery will not be used for an extended period, recharge it at least once every six months and run it flat before returning it to storage.

Charging the Battery

Charge the supplied Rechargeable Li-ion Battery EN-EL10 inserted into the camera, by connecting the supplied Charging AC Adapter EH-68P to the camera via the supplied USB Cable UC-E6, and then plugging the Charging AC Adapter into an electrical outlet.

1 Prepare the Charging AC Adapter EH-68P.

If a plug adapter* is included, attach the plug adapter to the plug on the Charging AC Adapter. Push the plug adapter firmly until it is securely held in place. Once the two are connected, attempting to forcibly remove the plug adapter could damage the product.

* The shape of the plug adapter varies according to the country or region in which the camera was purchased.

For Customers in Argentina

If the camera was purchased in Argentina, the shape of the Charging AC Adapter EH-68P (AR) differs from that supplied in other countries, and a plug adapter is not included. Proceed to step 2.

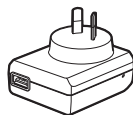
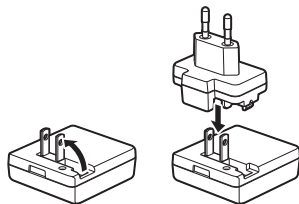

EH-68P (AR)

2 Be sure that the power-on lamp and the monitor are off.

Be sure to insert the battery into the camera (📖 14) and turn off the camera (📖 19).

3 Use the supplied USB cable to connect the Charging AC Adapter to the camera.

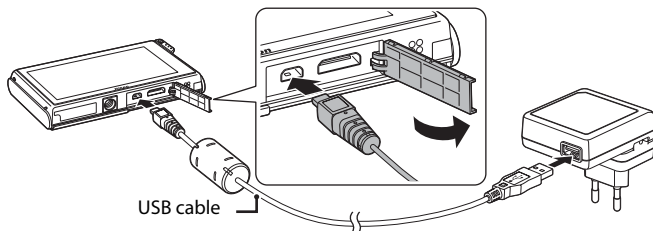

✓ Connecting the Cable

When connecting the cable, be sure that the connector is properly oriented. Do not use force when connecting the cable to the camera. When disconnecting the cable, do not pull the connector at an angle.

4 Plug the Charging AC Adapter into an electrical power outlet.

The power-on lamp slowly blinks orange to indicate that the battery is charging.

About 3 hours are required to charge a fully exhausted battery.

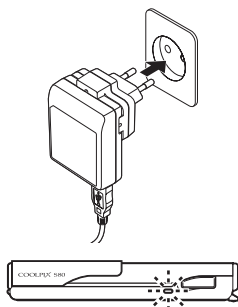

The following chart explains power-on lamp status when the camera is plugged into the electrical power outlet.

Power-on lamp	Description
Blinks slowly (orange)	Battery charging.
Off	Battery not charging. When charging is complete, the power-on lamp stops blinking orange and turns off.
Flickers (orange)	<ul style="list-style-type: none"> The ambient temperature is not suited to charging. Charge the battery indoors with an ambient temperature of 5 °C to 35 °C (41 °F to 95 °F). A USB cable is not correctly connected, nor is a Charging AC Adapter correctly plugged, or the battery is faulty. Disconnect the USB cable or unplug the Charging AC Adapter and correctly connect it again, or change the battery.

5 Disconnect the Charging AC Adapter from the electrical outlet and then disconnect the USB cable.

Charging the Battery

Notes on Charging AC Adapter

- The Charging AC Adapter EH-68P is for use only with compatible devices. Do not use with another make or model of device.
- Be sure to read and follow the warnings for the Charging AC Adapter on page iii and the section, “The Battery” (📖 167), before use.
- The EH-68P is compatible with AC 100-240 V, 50/60 Hz electrical outlets. When using in other countries, use a plug adapter (available commercially) as necessary. For more information about plug adapters, consult your travel agency.
- The Charging AC Adapter EH-68P is for charging the battery inserted into the camera. When the camera is connected to the Charging AC adapter, the camera cannot be turned on.
- Do not, under any circumstances, use another make or model of AC adapter other than Charging AC Adapter EH-68P or USB-AC adapter. Failure to observe this precaution could result in overheating or in damage to the camera.

AC Power Source

- If the AC Adapter EH-62D (available separately; 📖 169) is used, COOLPIX S80 can be powered from an electrical outlet and operated for shooting or playback.
- Do not, under any circumstances, use another make or model of AC adapter other than EH-62D. Failure to observe this precaution could result in overheating or in damage to the camera.

Charging Using Computer or Battery Charger

- Connecting the COOLPIX S80 to a computer also charges the Rechargeable Li-ion Battery EN-EL10 (📖 132, 137).
- The Battery Charger MH-63 (available separately; 📖 169) can be used to charge Rechargeable Li-ion Battery EN-EL10 without the camera.

Turning On and Off the Camera

To turn on the camera, open the slide cover.

After the power-on lamp (green) lights for a moment, the monitor will turn on.

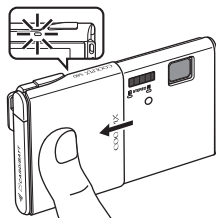

To turn off the camera, close the slide cover.

When the camera turns off, both the monitor and power-on lamp will turn off.

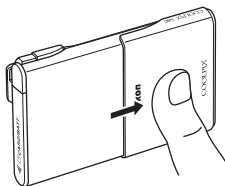

✔ Note on Opening the Slide Cover

Be sure to keep your fingers away from the lens when opening the slide cover.

🔋 Power Saving Function (Auto Off)

If no operations are performed for a while, the monitor will turn off, the camera will enter standby mode, and the power-on lamp will blink.

While the power-on lamp is blinking, press the shutter-release button to reactivate the monitor.

- Camera enters standby mode in about a minute (default setting) during shooting or playback mode.
- The time allowed to elapse before the camera enters standby mode can be changed from the **Auto off** option (📖 155) in the setup menu (📖 145).
- When the AC Adapter EH-62D (available separately, 📖 169) is connected, a screen saver function is activated to prevent screen burn when no operations are performed for about a minute (default setting, 📖 155).

Setting Display Language, Date and Time

A language-selection dialog is displayed the first time the camera is turned on.

1 Open the slide cover to turn on the camera.

The power-on lamp (green) will light for a moment and the monitor will turn on.

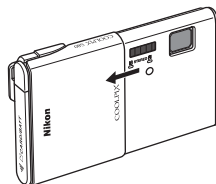

2 Tap the desired language.

If the desired language is not displayed, tap or to view other language options.

For more information about operating the touch panel, see "Operating the Touch Panel" (📖 6).



3 Tap Yes.

If **No** is tapped, the date and time will not be set.

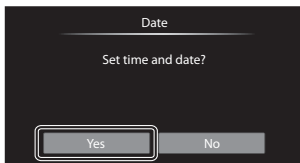

4 Tap or to select your home time zone (📖 150) and tap **OK**.

Tap to return to the previous screen.



Daylight Saving Time

If daylight saving time is in effect, tap in the time zone selection screen displayed in step 4 to turn on the daylight saving time function.

When the daylight saving time function is enabled, is displayed at the top of the monitor.

To turn off the daylight saving time function, tap again.



- 5** Tap the order in which the day, month, and year are displayed.

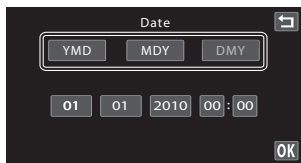

- 6** Edit the date and time.

Tap the desired item and ▲ or ▼ to edit the highlighted item.

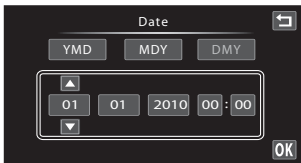

- 7** Tap **OK**.

The clock is activated and the camera enters shooting mode.

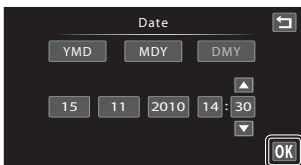

Imprinting and Changing the Date and Time

- To imprint the date on picture when shooting, enable date imprint from the **Date imprint** option (📖 152) in the setup menu (📖 145) after the date and time have been set.
- To change the date and time of the camera clock, select **Date** from the **Date** item (📖 148) in the setup menu (📖 145) and follow the procedure described from step 5.
- Select **Time zone** from the **Date** item (📖 148) in the setup menu to change the time zone and daylight saving time settings.

Inserting Memory Cards

Recorded data are stored in the camera's internal memory (approximately 79 MB) or on removable Secure Digital (SD) memory cards (available separately;  170).

If a memory card is inserted in the camera, data are automatically stored on the memory card and data recorded to the memory card can be played back, deleted or transferred. Remove the memory card to store data in the internal memory, or play back, delete or transfer data from the internal memory.

- 1 Be sure that the power-on lamp and the monitor are off and open the battery-chamber/memory card slot cover.

Be sure to turn off the camera before opening the battery-chamber/memory card slot cover.

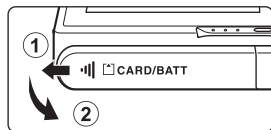

- 2 Insert the memory card.

Slide the memory card in the correct orientation shown at right until it clicks into place.

Close the battery-chamber/memory card slot cover.

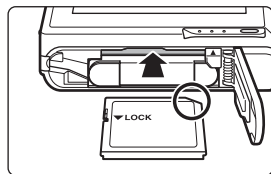

Inserting Memory Cards

Inserting the memory card upside down or backwards could damage the camera or the memory card. Be sure that the memory card is in the correct orientation.

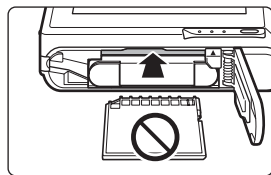

Removing Memory Cards

Before removing memory cards, close the slide cover to turn the camera off and be sure that the power-on lamp and monitor are off. Open the battery-chamber/memory card slot cover and press the card in (1) to partially eject the card. The card can then be removed by hand (2). Do not attempt to remove the card at an angle.

- Note that the battery and memory card may become hot during use; observe due caution when removing the memory card.

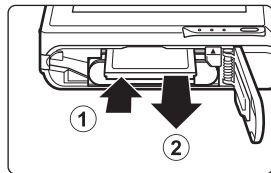

✓ Formatting Memory Cards

If the message at right is displayed when the camera is turned on, the memory card must be formatted before use (📖 156). Note that **formatting permanently deletes all pictures and other data on the memory card**. Be sure to make copies of any pictures you wish to keep before formatting the memory card.

Tap **Yes** to format. When the confirmation dialog is displayed, tap **Yes**. To start formatting, tap **OK**.

- Do not turn the camera off or open the battery-chamber/memory card slot cover until formatting is complete.
- Be sure to use the COOLPIX S80 to format memory cards previously used in other devices the first time they are inserted into this camera (📖 156).

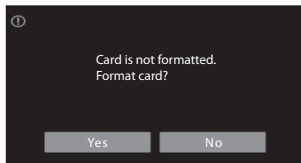

✓ The Write Protect Switch

Memory cards are equipped with a write protect switch. When this switch is in the “lock” position, data cannot be written to, or deleted from, the memory card. If the switch is in the “lock” position, unlock it by sliding the switch to the “write” position to record or delete pictures, or to format the memory card.

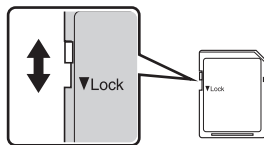

Write protect switch



✓ Memory Cards

- Use only Secure Digital memory cards.
- Do not perform the following during formatting, while data is being written to or deleted from the memory card, or during data transfer to a computer. Failure to observe this precaution could result in the loss of data or in damage to the camera or memory card:
 - Take out the battery or memory card
 - Turn off the camera
 - Disconnect the AC adapter
- Do not use a computer to format the memory card.
- Do not disassemble or modify.
- Do not drop, bend, or expose to water or strong physical shock.
- Do not touch the metal terminals with your fingers or metal objects.
- Do not affix labels or stickers to the memory card.
- Do not leave in direct sunlight, closed vehicles or areas exposed to high temperatures.
- Do not expose to humidity, dust, or corrosive gases.

Step 1 Turn the Camera On and Select  Easy Auto Mode

In  (easy auto) mode, the camera automatically selects the optimum shooting mode by framing a picture, allowing you to easily take pictures using a shooting mode that suits the scene ( 49).

1 Open the slide cover to turn on the camera.

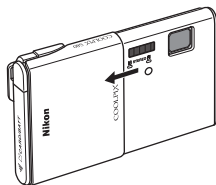

The power-on lamp (green) will light for a moment and the monitor will turn on.

 (easy auto) mode is initially activated at the time of purchase. Proceed to step 4.

**2 Tap the shooting mode icon.****3 Tap .**

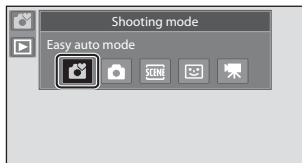
The camera enters  (easy auto) mode.

**4 Check the battery level and the number of exposures remaining.**

Battery Level	Description
NO INDICATOR	Battery fully charged.
	Battery low. Prepare to charge or replace the battery.
 Battery exhausted.	Cannot take pictures. Recharge or replace with a fully charged battery.

Number of Exposures Remaining

Indicator is displayed when there are 50 or fewer exposures remaining.

The number of pictures that can be stored depends on the capacity of the internal memory or memory card and image mode setting ( 39).







Battery level indicator



Number of exposures remaining

Indicators Displayed in (Easy Auto) Mode

Shooting mode

In easy auto mode, , , , , , or  is displayed to indicate the shooting mode selected by the camera for the current subject and framing.



Vibration reduction

The effects of camera shake are reduced.

Internal memory indicator



Indicates that images will be stored in the camera's internal memory (approximately 79 MB). When a memory card is inserted,  is not displayed and pictures will be stored to memory card.

To reactivate the monitor after it is turned off by the power saving function in standby mode ( 155), press the shutter-release button.

Note on Touch Shutter

At the default setting, the shutter can be released by simply tapping a subject in the monitor ( 41). Take care that you do not release the shutter accidentally.



Note on Printing Pictures

When printing pictures taken at an **Image mode** setting of  **3968x2232** (default setting), the edges of pictures may be cropped, preventing printing of complete pictures ( 138).

Functions Available in (Easy Auto) Mode

- When the camera is pointed at a human face, the face detection function, with which the camera automatically detects that face and focus on it, activates ( 28, 49).
- Shooting settings ( 32) can be changed by tapping the left or bottom tab to display the setting controls ( 12).

Vibration Reduction

- See " Vibration Reduction" ( 153) in the setup menu ( 145) for more information.
- Set **Vibration reduction** to **Off** when using a tripod to stabilize the camera during shooting.

Step 2 Frame a Picture

1 Ready the camera.

Hold the camera steadily in both hands, keeping your fingers and other objects away from the lens, flash, AF-assist illuminator, microphone, and speaker.

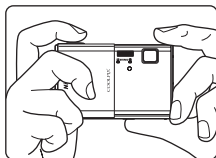

When taking pictures in portrait ("tall") orientation, turn the camera so that the built-in flash is above the lens.

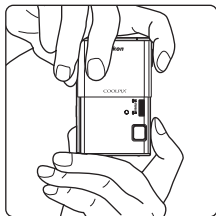

2 Frame the picture.

When the camera automatically selects the optimum scene mode, the shooting mode icon will be changed (📖 49).

When the camera detects a face, that face will be framed by a yellow double border (focus area).

Up to 12 faces can be detected. If more than one face is detected, the face closest to the camera will be framed by a double border, and the others by a single border.

When taking pictures of subjects other than people, or framing a subject with which no face is detected, a focus area will not be displayed. Frame the picture so that the intended subject is at or near the center of the frame.

Shooting mode icon

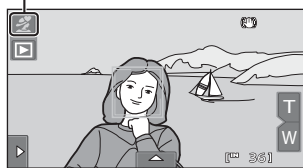

✓ Notes on 📷 (Easy Auto) Mode

- The desired scene mode may not be selected in certain condition. In this case, select another shooting mode.
- When digital zoom is in effect, shooting mode is 📷.

Using the Zoom

Tap **T** or **W** to activate optical zoom.

- To enlarge the subject: tap **T**.
- To capture a wide area: tap **W**.
- The zoom position is set at the maximum wide-angle position when the camera is turned on.
- A zoom indicator is displayed in the monitor during zooming.

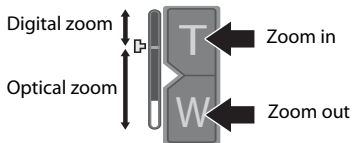

Digital Zoom



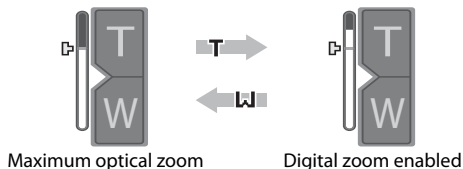

When the camera is zoomed in to the maximum optical zoom position, touching and holding **T** triggers digital zoom. The subject is magnified up to 4x the maximum optical zoom ratio.

The camera focuses at the center of the frame and the focus area is not displayed when digital zoom is in effect.



Digital Zoom and Interpolation

Unlike optical zoom, digital zoom uses a digital imaging process known as interpolation to magnify images, resulting in slight deterioration of picture quality.

Interpolation is applied at zoom positions beyond . When zoom is increased beyond the  position, interpolation is initiated and the zoom indicator turns yellow to indicate that interpolation is being applied. The position of  moves to the top as image size decreases, allowing for confirmation of the zoom positions at which shooting without interpolation is possible at the current image mode setting ( 38).

Digital zoom can be disabled from the **Digital zoom** option ( 154) in the setup menu ( 145).

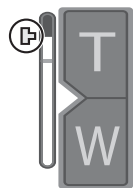

Small image size

Step 3 Focus and Shoot

1 Press the shutter-release button halfway.

Focus is locked when the shutter-release button is pressed halfway (📖 5).

When a face is detected, it is framed by the double border indicating the active focus area. When the subject is in focus, the double border turns green.

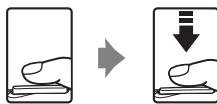

Shutter speed Aperture

When no face is detected, the camera automatically selects the focus area (up to nine areas) suitable to the shooting scene. When the subject is in focus, the focus area (📖 8, 49) that is selected glows green.

When digital zoom is used, the focus area is not displayed and the camera focuses at the center of the frame. Once focus has been acquired, the focus indicator will glow green.

Focus indicator

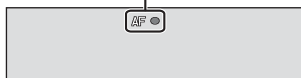

Shutter speed and aperture value are displayed when the shutter-release button is pressed halfway.

The focus and exposure remain locked while the shutter-release button is pressed halfway.

When the camera detects subject movement or camera shake and increases shutter speed, the shutter speed indicator will turn green (Motion detection; 📖 50).

If the focus area or the focus indicator blinks red when the shutter-release button is pressed halfway, the camera is unable to focus. Modify the composition and press the shutter-release button halfway again.

2 Press the shutter-release button the rest of the way down.

The shutter is released and the picture will be recorded to the memory card or internal memory.



✔ During Recording

While pictures are being recorded, the number of exposures remaining will blink. **Do not open the battery-chamber/memory card slot cover** while pictures are being recorded. Cutting power or removing the memory card in these circumstances could result in loss of data or in damage to the camera or card.

✔ Autofocus

Autofocus may not perform as expected in the following situations. In some rare cases, the subject may not be in focus despite the fact that the focus area or the focus indicator glows green.

- Subject is very dark
- Objects of sharply differing brightness are included in the scene (e.g. the sun behind the subject makes that subject appear very dark)
- No contrast between the subject and surroundings (e.g. a portrait subject, wearing a white shirt, is standing in front of a white wall)
- Several objects are at different distances from the camera (e.g. the subject is inside a cage)
- Regular geometric patterns (e.g. window blind or windows in a skyscraper)
- Subject is moving rapidly

In the situations noted above, try pressing the shutter-release button halfway to refocus several times, or focus on another subject (📖 46). When focusing on another subject, be sure that the alternate subject is at the same distance from the camera as the intended subject while the shutter-release button is pressed halfway.

✔ Note on Face Detection

See “Notes on Face Detection” (📖 49) for more information.

📎 Touch Shutter

At the default setting, the shutter can be released by simply tapping a subject in the monitor (📖 41) without pressing the shutter-release button. The **Touch shutter** option can be changed to the **Touch AF/AE** option, which allows the camera to set the focus and exposure on the subject that is tapped on the monitor. When using the **Touch AF/AE** option, the picture is taken by pressing the shutter-release button (📖 44).

📎 Blink Warning Screen

When the camera detects that portrait subjects may have blinked when a picture was taken in face detection mode with **Blink warning** set to **On**, the blink warning screen (📖 159) is displayed in the monitor.

📎 AF-assist Illuminator and Flash

If the subject is poorly lit, the AF-assist illuminator (📖 154) may light when the shutter-release button is pressed halfway, or the flash (📖 33) may fire when the shutter-release button is pressed all the way down.

Step 4 Playing Back and Deleting Pictures

Playing Back Pictures (Playback Mode)

Tap .

Shooting



Playback

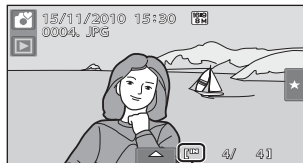

Internal memory indicator

The last picture taken will be displayed in full-frame playback mode.

Drag the current picture to display previous or subsequent picture. Use two fingers to scroll ahead or back ten pictures at a time (📖 6).

Display the previous picture

Display the subsequent picture

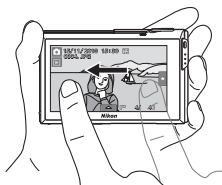
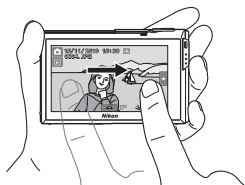

The previous or subsequent picture may appear briefly at low resolution immediately after it is dragged into view.

Tap the shooting mode icon () displayed at upper left in the monitor or press the shutter-release button to return to shooting mode.

 is displayed when pictures stored in the camera's internal memory are played back. When a memory card is inserted in the camera,  is not displayed and pictures stored on the memory card are played back.

Options Available in Playback Mode

See "More on Playback" (📖 78) or "Editing Pictures" (📖 109) for more information.

Viewing Pictures

- Pictures taken in portrait ("tall") orientation will be rotated automatically (📖 11). The rotating direction can be changed from the **Rotate image** option (📖 106). When the camera is rotated, the picture displayed is also rotated (📖 11).
- When the monitor has turned off in standby mode to save power, press the shutter-release button to reactivate it (📖 155).

Deleting Unwanted Pictures

- 1 Play back a picture to be deleted, tap the bottom tab to display the setting controls (📖 12), and tap 🗑️.

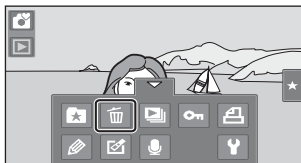

- 2 Tap the desired delete option.

Current image: Delete the currently displayed full-frame picture or movie (📖 128).

Erase selected images: Select multiple pictures and delete them. See “Operating the Erase Selected Images Screen” for more information.

All images: Delete all pictures.

Select either **Erase selected images** or **All images** when performing the step 1 in thumbnail playback mode (📖 79).

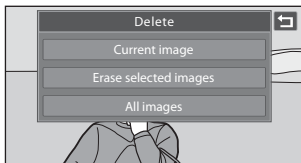

- 3 Tap **Yes** on the delete confirmation dialog.

Deleted pictures cannot be recovered.

To exit without deleting the picture, tap 🔄 or **No**.

No.

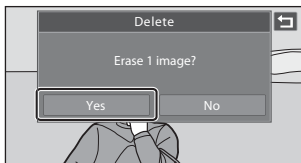

Operating the Erase Selected Images Screen

- 1 Tap a picture to display ✓.

To deselect the picture, tap the picture again and ✓ will be hidden.

Tap 🔍 or 🔍 to change the number of pictures displayed.



- 2 Display ✓ to all pictures to delete and tap **OK** to apply the selection.

The confirmation screen is displayed. Follow the onscreen instructions for more operations.

Notes on Deleting Pictures

- Once deleted, pictures cannot be recovered. Transfer important pictures to a computer before deleting them.
- Protected pictures cannot be deleted (📖 100).

Basic Shooting Functions

In  (easy auto) mode, the settings of the following functions can be made. Each icon also indicates the current setting.



1









2

3

4









5

1		Flash.....	33
2		Self-timer.....	36
3		Image mode.....	38

4		Touch shooting	
		Touch shutter.....	41
		Touch AF/AE.....	44
5		Exposure compensation.....	47

⚡ Using the Flash

Flash mode can be selected to suit the shooting conditions.

- When **ISO sensitivity** is set to **Auto**, the flash has a range of 0.5-4.0 m (1 ft. 8 in.-13 ft.) at the maximum wide-angle zoom position and a range of 0.5-2.5 m (1 ft. 8 in.-8 ft. 2 in.) at the maximum telephoto zoom position.
- Note that in  (easy auto) mode ( 24), only  **Auto** (default setting) and  **Off** are available. When  **Auto** is selected, the camera sets the flash mode according to the automatically selected scene mode.
- In auto shooting mode ( 53), some scene modes ( 61), or smart portrait mode ( 72), the following flash modes are available.



Auto

Flash fires automatically when lighting is poor.



Auto with red-eye reduction

Suited to pictures of people, this option reduces the “red-eye” phenomenon ( 35).



Off

Flash will not fire even when lighting is poor.



Fill flash

Flash fires whenever a picture is taken. Use to “fill-in” (illuminate) shadows and back-lit subjects.



Slow sync

 (auto) is combined with slow shutter speed.

Suited to evening and night portraits that include background scenery. Flash illuminates main subject; slow shutter speeds are used to capture background at night or under dim lighting.

Setting the Flash Mode

- 1 Tap the left tab to display the setting controls (📖 12), and tap the flash mode icon.

The flash mode menu is displayed.



- 2 Tap the desired flash mode icon.

Tap 🏠 to return to the previous screen.

To hide the setting controls after applying the setting, tap the tab again.

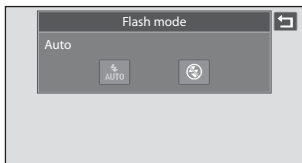

✔ Shooting When the Flash is Disabled (🚫) or Lighting is Poor

- Use of a tripod is recommended during shooting. Set **Vibration reduction** (📖 153) to **Off** from the setup menu (📖 145) when using a tripod to stabilize the camera.
- The noise reduction function may be activated with some shooting conditions such as dim lighting. More time than usual is required to record pictures to which noise reduction is applied.

✔ Note on Using the Flash

When using the flash, reflections from dust particles in the air may appear as bright spots in pictures. To reduce these reflections, set the flash to 🚫 (off).

📌 The Flash Indicator

The flash indicator shows flash status when the shutter-release button is pressed halfway.





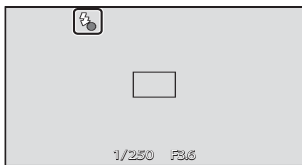



- On: Flash will fire when picture is taken.
- Blinks: Flash charging. Wait a few seconds and try again.
- Off: Flash will not fire when picture is taken.

If the battery is low, the monitor will turn off, and remain off, while the flash charges.



The Flash Mode Setting

The default flash mode setting varies with shooting mode.

-  (easy auto) mode:  (auto)
-  (auto) mode:  (auto)
- Scene: varies with the selected scene mode ( 62)
-  (smart portrait): fixed at  (auto) when **Off** is selected for **Blink proof**.  (off) when **On** is selected for **Blink proof** ( 75)

There are functions with which the flash cannot be enabled. See “Camera Settings That cannot be Applied Simultaneously” ( 76) for more information.

The flash mode setting applied in  (auto) mode is stored in the camera’s memory even after the camera is turned off.

Red-eye Reduction

This camera uses advanced red-eye reduction (“In-Camera Red-Eye Fix”). To reduce red-eye, a series of low-intensity pre-flashes fire before the main flash. In addition, if the camera detects red-eye when a picture is taken, the affected area is processed to reduce red-eye before the picture is saved. Note the following when shooting:

- Due to the pre-flashes, there is a longer than usual interval between the time the shutter-release button is pressed and the time the shutter is released.
- More time than usual is required to record pictures.
- Red-eye reduction may not produce the desired results in some situations.
- In extremely rare instances, areas not subject to red-eye may be affected by red-eye reduction processing; in these cases, choose another flash mode and try again.

🕒 Taking Pictures with the Self-timer

The camera is equipped with a ten-second and two-second timer for self-portraits. This feature is useful for reducing the effects of camera shake that occurs when pressing the shutter-release button. The self-timer setting can be selected from 10 or 2 seconds duration. When using the self-timer, use of a tripod is recommended. Set **Vibration reduction** (📖 153) to **Off** from the setup menu (📖 145) when using a tripod to stabilize the camera.

- 1 Tap the bottom tab to display the setting controls (📖 12), and tap the self-timer icon.



- 2 Tap **10s** or **2s**.

10s (ten seconds): Use on important occasions, such as weddings

2s (two seconds): Use to prevent camera shake
The selected self-timer mode is displayed.

Tap  to return to the previous screen.

To hide the setting controls after applying the setting, tap the tab again.

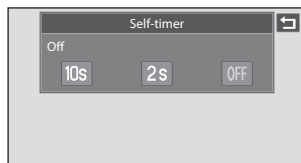

- 3 Frame the picture and press the shutter-release button halfway.

Focus and exposure will be locked.

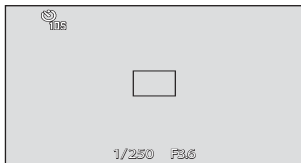

4 Press the shutter-release button the rest of the way down.

The self-timer starts, and the number of seconds remaining before the shutter is released is displayed in the monitor. The self-timer lamp blinks while the timer is counting down. About one second before the shutter is released, the lamp stops blinking and glows steadily.

When the shutter is released, the self-timer turns off.

To stop the timer before a picture is taken, press the shutter-release button again.

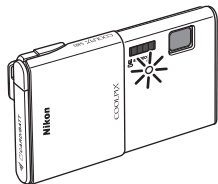
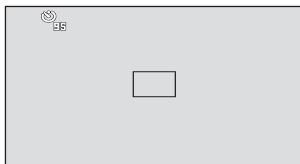

Note on Self-timer

There are functions with which this setting cannot be enabled. See “Camera Settings That cannot be Applied Simultaneously” (📖 76) for more information.

Image Mode (Image Quality/Image Size)

Image mode refers to the combination of image size and image quality (compression) at which pictures are recorded. Choose the image mode best suited to the manner in which pictures will be used and the capacity of the internal memory or memory card. The higher the image mode setting, the larger the size at which it can be printed or displayed without appearing noticeably “grainy,” but limiting the number of pictures that can be recorded.

Option	Size (pixels)	Description
4320×3240★	4320 × 3240	Higher quality than suitable for enlargements or high-quality prints. The compression ratio is approximately 1:4.
4320×3240	4320 × 3240	Best choice in most situations. The compression ratio is approximately 1:8.
3264×2448	3264 × 2448	
2592×1944	2592 × 1944	Smaller size than , , or allows more pictures to be stored. The compression ratio is approximately 1:8.
2048×1536	2048 × 1536	
1024×768	1024 × 768	Suited to display on a computer monitor. The compression ratio is approximately 1:8.
640×480	640 × 480	Suited to full-screen display on a television with an aspect ratio of 4:3, or distribution by e-mail or the web. The compression ratio is approximately 1:8.
3968×2232 (default setting)	3968 × 2232	Pictures with an aspect ratio of 16:9 are recorded. The compression ratio is approximately 1:8.

- Tap the bottom tab to display the setting controls (📖 12), and tap the image mode icon.

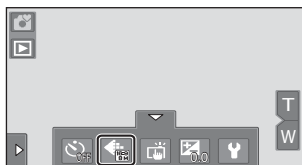

- Tap the desired image mode icon.

Tap to return to the previous screen.

To hide the setting controls after applying the setting, tap the tab again.





Note on Printing Pictures

When printing pictures taken at an **Image mode** setting of  **3968×2232** (default setting), the edges of pictures may be cropped, preventing printing of complete pictures.

It may be possible to print complete pictures if settings on the printer are applied so that borders are printed around pictures (borderless printing not enabled).









Refer to the documentation supplied with the printer or consult the digital photo lab for further details to make sure that the printer supports printing at an aspect ratio of 16:9.

Image Mode

- The setting can also be changed in shooting modes other than  (easy auto) mode (except movie recording).
- Changes made to this setting apply to all shooting modes (except movie recording).
- There are functions with which this setting cannot be enabled. See “Camera Settings That cannot be Applied Simultaneously” ( 76) for more information.

Number of Exposures Remaining

The following table lists the approximate number of pictures that can be stored in internal memory and on a 4 GB memory card. Note that the number of pictures that can be stored will differ depending on the composition of the picture (due to JPEG compression). In addition, this number may vary depending upon the make of memory card, even when the memory cards have the same specified capacity.

Setting	Internal memory (approx. 79 MB)	Memory card (4 GB)	Print size* (cm/in.)
 4320×3240★	11	550	Approx. 36 × 27/14 × 10.5
 4320×3240	23	1100	Approx. 36 × 27/14 × 10.5
 3264×2448	40	1910	Approx. 28 × 21/11 × 8
 2592×1944	62	2940	Approx. 22 × 16/8.5 × 6.5
 2048×1536	97	4640	Approx. 17 × 13/7 × 5
 1024×768	316	15000	Approx. 9 × 7/3.5 × 2.5
 640×480	563	24100	Approx. 5 × 4/2 × 1.5
 3968×2232	36	1720	Approx. 34 × 19/13 × 7

* Print size at an output resolution of 300 dpi. Print sizes are calculated by dividing the number of pixels by printer resolution (dpi) and multiplying by 2.54 cm (1 in.). However, at the same image size, pictures printed at higher resolutions will print smaller than the size indicated, and those printed at lower resolutions will print larger than the size indicated.

- The number of exposures remaining is displayed on the shooting display when 50 or fewer remain ( 24).
- If there are 10,000 or more pictures saved in the camera, “9999” is displayed on the playback screen as the current frame number or total number of frames.

Image Mode Setting and Monitor Display

Monitor display in shooting and playback modes varies as indicated below according to the image mode setting.

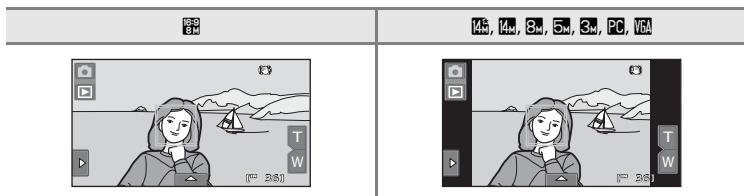

Tapping the Monitor to Release the Shutter (Touch Shutter)

Pictures can be taken by simply tapping the monitor.

- **Touch shutter** is set by default. Proceed to step 3.

- 1 Tap the bottom tab to display the setting controls (book 12), and tap the touch shooting icon.



- 2 Tap  (touch shutter).

Tap  to return to the previous screen.

To hide the setting controls after applying the setting, tap the tab again.

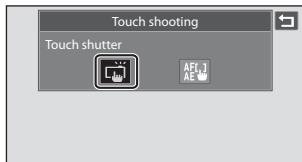

- 3 Tap the desired subject to take a picture.



When a face is detected in  (easy auto) mode, it is framed by a border. Tap a detected face to set the focus and exposure on that face.

When no face is detected, the camera focuses on the area that is tapped.

Do not use force when tapping the monitor as this may cause slight movement of the camera, resulting in blurred pictures.



When digital zoom is in effect, the camera focuses on the subject in the center of the frame.

The shutter-release button can also be used when the touch shutter option is selected.

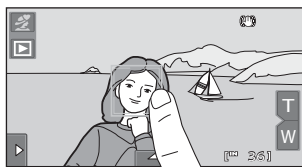
If  is displayed when the monitor is tapped, the shutter cannot be released. Tap an area within  or a border displayed when the camera detects a face.











Notes on Touch Shutter

- When taking pictures with **Continuous** or **BSS** in **Continuous** setting (📖 58) enabled, or in **Sports** or **Museum** scene mode (📖 61), use the shutter-release button to take pictures. Only one picture can be taken at a time using the touch shutter function.
- Prevent shooting with accidental tapping of the monitor in  (easy auto) mode,  (auto) mode, and some scene modes by changing the touch shooting setting to **Touch AF/AE** (📖 44). At this setting, the shutter is not released when the monitor is tapped.
- When shooting subjects with which autofocus may not perform as expected, the subject may not be in focus (📖 29).
- When a subject displayed in the monitor is tapped with the self-timer (📖 36) enabled, the camera locks focus and releases the shutter after ten or two seconds.
- There are functions with which this setting cannot be enabled. See “Camera Settings That cannot be Applied Simultaneously” (📖 76) for more information.

Shooting Modes That Support Touch Shutter

The touch shutter can be used in  (easy auto) mode and other shooting modes. Touch shutter operation differs according to the current shooting mode as follows.

Shooting mode	Touch shutter operation
 (easy auto) mode ( 24)	<ul style="list-style-type: none"> When a face is detected by the camera, it is framed by a border. Tap a detected face to set the focus and exposure on that face. When no face is detected, focus is set for the area tapped.
 (auto) mode ( 51), Sports, Party/indoor, Beach, Snow, Close-up, Food, Museum, Copy, and Backlighting scene modes ( 61)	Tap the intended subject. Focus and exposure are set for the area tapped. When the camera detects more than one face, tap a face framed by a single border to set focus and exposure for that face.
Portrait and Night portrait scene modes ( 61)	Only a border displayed by the face detection function can be selected. When the camera detects more than one face, tap a face framed by a single border to set focus and exposure for that face.
Landscape, Sunset, Dusk/dawn, Night landscape, Fireworks show, and Panorama assist scene modes ( 61)	Focus and exposure are set for the same focus area used when pictures are taken by pressing the shutter-release button. See "Selecting a Scene Mode to Take Pictures (Features)" ( 64) for more information.
Smart portrait mode ( 72)	Touch shutter cannot be enabled.

Touch Shutter Function When Recording Movies

Touch shutter is also available when recording movies. Movie recording can be initiated or stopped by tapping the monitor ( 124).

Touch Shooting Setting

The touch shooting setting applied in  (auto) mode is stored in the camera's memory even after the camera is turned off.

Af.1 **AE** **Tapping the Monitor to Focus (Touch AF/AE)**

The touch shooting setting can be changed from **Touch shutter** (default setting) to **Touch AF/AE**.

Tap a subject in the monitor to select the area at which the camera focuses. Press the shutter-release button halfway to lock focus and exposure for the area tapped, and press the shutter-release button the rest of the way down to take the picture.

- 1** Tap the bottom tab to display the setting controls (📖 12) and tap the touch shooting icon.

The menu of the touch shooting setting is displayed in the monitor.

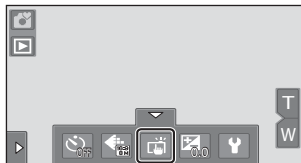

- 2** Tap **Af.1** **AE** (touch AF/AE).

Tap **☐** to return to the previous screen.

To hide the setting controls after applying the setting, tap the tab again.

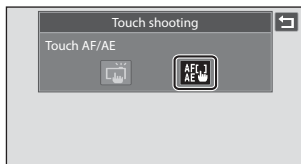

- 3** Tap the subject at which the camera focuses.

When faces are detected in **☺** (easy auto) mode, only those faces surrounded by the frame can be tapped to change the focus subject. When multiple faces are detected, tap a face framed by a single border to move the focus area to that face.

When no face is detected, the camera focuses on the area that is tapped.

☐☐ or a double border will be displayed at the area tapped.

When digital zoom is in effect, the focus area cannot be selected.

To cancel the focus area selection, tap **☐☐** displayed at the left side of the monitor.

If a position at which focus cannot be acquired is tapped, ☐☐ will be displayed in the monitor. Tap another position inside ☐☐.



4 Press the shutter-release button to take a picture.

Press the shutter-release button halfway to acquire focus and exposure and press it all the way down to release the shutter.



✔ Note on Touch AF/AE

When shooting subjects with which autofocus may not perform as expected, the subject may not be in focus (📖 29).

🔑 Shooting Modes That Enable Touch AF/AE Function

The touch AF/AE can be used in 📷 (easy auto) mode and other shooting modes. Touch AF/AE operation differs according to the current shooting mode as follows.



Shooting mode	Touch AF/AE operation
📷 (easy auto) (📖 24)	<ul style="list-style-type: none"> When the camera detects a face, only a face framed by a border can be selected. When the camera detects more than one face, tap a face framed by a single border to set focus and exposure for that face. The single border changes to a double border. When no face is detected, focus is set for the area tapped.
📷 (auto) mode (📖 51), Sports, Party/indoor, Beach, Snow, Close-up, Food, Museum, Copy, and Backlighting scene modes (📖 61)	Focus and exposure are set for the area tapped.
Portrait and Night portrait scene modes (📖 61), smart portrait mode (📖 72)	Only a border displayed by the face detection function can be selected. When the camera detects more than one face, tap a face framed by a single border to move the focus area to that face.
Landscape, Sunset, Dusk/dawn, Night landscape, Fireworks show, and Panorama assist scene modes (📖 61)	Touch AF/AE cannot be enabled.

Touch Shooting Setting

The touch shooting setting applied in  (auto) mode is stored in the camera's memory even after the camera is turned off.

Taking Pictures of Subjects with Which Autofocus may not Perform as Expected

When taking pictures of subjects with which autofocus may not perform as expected ( 29), try pressing the shutter-release button halfway to refocus several times, or try the following techniques.

- 1 Switch to  (auto) mode ( 51) and select **Touch AF/AE** for the touch shooting setting.

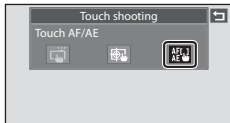

- 2 Tap another subject that is as far from the camera as the desired subject.



- 3 Press the shutter-release button halfway.

- The camera focuses on the subject and the focus area glows green.
- Exposure is locked for the subject on which focus is acquired when the shutter-release button is pressed halfway.

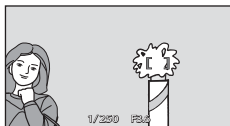

- 4 Continue holding down the shutter-release button halfway and recompose the picture.

- Be sure to maintain the same distance between the camera and the subject while the shutter-release button is pressed halfway.



- 5 Press the shutter-release button the rest of the way down to take the picture.



Changing Brightness Using Exposure Compensation

Exposure compensation is used to alter exposure from the value suggested by the camera to make pictures brighter or darker.

- 1 Tap the bottom tab to display the setting controls ( 12), and tap the exposure compensation icon.

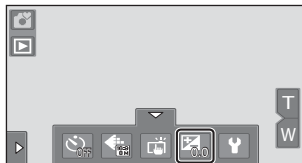

- 2 Drag the slider to change the exposure compensation value.

To make the picture brighter, apply positive (+) exposure compensation.

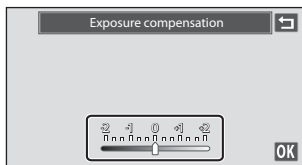

To make the picture darker, apply negative (-) exposure compensation.

Tap  to return to the previous screen.



- 3 Tap .

To hide the setting controls after applying the setting, tap the tab again.

To cancel the exposure compensation, return to step 1, revert the value to , and tap .



Exposure Compensation Value

The exposure compensation value applied in  (auto) mode ( 51) is stored in the camera's memory even after the camera is turned off.

Selecting a Shooting Mode

The following shooting modes can be selected.

Easy auto mode 📖 24

By simply framing a picture, the camera automatically selects the optimum shooting mode.

Auto mode 📖 51

Pictures can be taken with the flash mode or macro mode setting. Other settings can be made, such as the continuous shooting setting or the "subject tracking" option, which moves the active focus area to track the selected subject.

Scene mode 📖 61

Camera settings are automatically optimized for the selected scene.

Smart portrait 📖 72

The camera uses face detection to detect human faces, and then automatically releases the shutter when a smile is detected. The skin softening option can be used to make skin tones of human faces displayed smoothly.

Movie 📖 124

Shoot movies with sound recorded via the built-in microphone.

1 Tap the shooting mode icon in shooting mode.

The shooting mode selection menu is displayed.



2 Tap the desired shooting mode icon.

The camera enters the selected shooting mode.

To select a scene mode, first tap  (scene), and then tap the icon of the desired scene mode (📖 61).



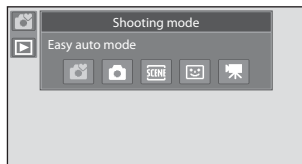



To return to the current shooting mode, tap the shooting mode icon at the upper left of the screen or press the shutter-release button.





(Easy Auto) Mode

Automatic Scene Selection

The camera automatically selects one of the following scenes when pointing the camera at a subject.

-  Auto mode (general use)
-  Portrait (📖 64)
-  Landscape (📖 64)
-  Night landscape (📖 66)
-  Night portrait (📖 65)
-  Backlighting (📖 69)
-  Close-up (📖 67)

Focusing in Easy Auto Mode

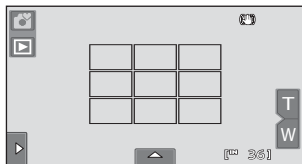

When  or  is displayed, the camera automatically selects one or more of the nine focus areas containing the subject closest to the camera.

Press the shutter-release button halfway to activate the focus area. When the shutter-release button is pressed halfway, the focus area (up to nine areas) selected by the camera will be displayed in the monitor.



Face Detection



When the camera is pointed at a human face, face detection, with which the camera automatically detects that face and focus on it, starts. The face detection function is activated in the following situations.

- In  (easy auto) (📖 24) mode
- In  (auto) (📖 51) mode
- In **Portrait** (📖 64) and **Night portrait** (📖 65) scene modes
- In smart portrait mode (📖 72)

Notes on Face Detection

- The camera may be unable to recognize faces in the following situations:
 - When faces are partially hidden by sunglasses or other obstructions
 - When faces take up too much or too little of the frame
- When the frame includes more than one face, the faces detected by the camera and the face on which the camera focuses depend upon a variety of factors, including the direction in which the faces are looking.
- In some cases, including those noted in "Autofocus" (📖 29), autofocus may not perform as expected, and the subject may not be in focus despite the fact that the double border glows green. Should this occur, refocus on another subject positioned at the same distance from the camera as the actual portrait subject (📖 46).

Motion Detection

In  (easy auto) mode or  (auto) mode, when the camera detects subject movement or camera shake, ISO sensitivity and shutter speed are increased to reduce blurring. In this case, the shutter speed indicator will turn green.

- Motion detection may be unable to completely eliminate the effects of subject movement and camera shake in some situations.
- Motion detection may not function if the subject exhibits significant movement or is too dark.
- The pictures taken using motion detection may be somewhat “grainy” in appearance.

Shooting in (Auto) Mode

Shooting settings such as flash mode and macro mode can be made. The **Continuous** setting or the **Subject tracking** option, with which the active focus area moves to track the selected subject, can also be made or applied.

- 1 Tap the shooting mode icon in shooting mode.

The shooting mode selection menu is displayed.



- 2 Tap .

The camera enters  (auto) mode.

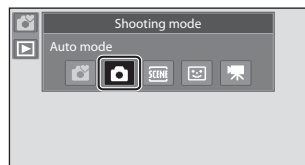

- 3 Tap the left or bottom tab to display the setting controls ( 12), and check or adjust the settings.

Tap a setting icon to adjust the setting.

See "Adjusting the  (Auto) Mode Setting" ( 53) for more information.





4 Frame the subject and take a picture.

When the camera detects a face, a yellow double border (focus area) is displayed around that face. When the shutter-release button is pressed halfway, the camera focuses on that face framed by a double border ( 26, 49).



When taking pictures of subjects other than people, or framing a subject with which no face is detected, the camera automatically selects one or more of the nine focus areas containing the subject closest to the camera ( 49). When focus is set, the active focus area (up to nine areas) turns green.

A picture is taken when the shutter-release button is pressed all the way down.

At the default setting, the shutter can be released by simply tapping a subject in the monitor ( 41) without pressing the shutter-release button. The **Touch shutter** option can be changed to the **Touch AF/AE** option, which allows the camera to set the focus and exposure on the subject that is tapped on the monitor. When using the **Touch AF/AE** option, the picture is taken by pressing the shutter-release button ( 44).









More Information

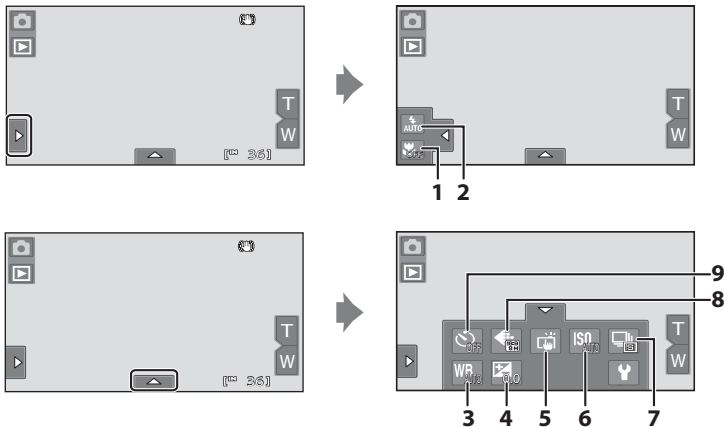

Adjusting the (Auto) Mode Setting

In  (auto) mode, the camera settings indicated below can be adjusted by tapping the tabs to display the setting controls.

- Each icon also indicates the current setting.
- Tap the icon of the desired item to display the setting screen for that item.
- To hide the setting controls, tap the tab again.



1	 Macro mode* 54
2	 Flash mode* 33
3	WB White balance* 59
4	 Exposure compensation* 47
5	Touch shooting*
	 Touch shutter 41
	 Touch AF/AE 44
	 Subject tracking 55

6	ISO ISO sensitivity* 57
7	 Continuous* 58
8	 Image mode* 38
9	 Self-timer 36

* The settings applied in  (auto) mode are stored in the camera's memory even after the camera is turned off.

Camera Settings That cannot be Applied Simultaneously

Some shooting settings cannot be used with other functions. See "Camera Settings That cannot be Applied Simultaneously" (📖 76) for more information.

📷 Macro Mode Setting

📷 (auto) → Tap the left tab → 📷 Macro mode

Macro mode is used for taking pictures of objects as close as 7 cm (2.8 in.). Note that the flash may be unable to light the entire subject at distances of less than 50 cm (1 ft. 8 in.).

1 Tap ON.



2 Tap T or W and frame the picture.

The closest possible shooting distance may vary according to the zoom position. The camera can focus at a closer distance when 📷 and the zoom indicator glow green and the zoom indicator is positioned below ▷ (wide-angle position). The camera can focus on the subject as close as 7 cm (2.8 in.) to the lens at the maximum wide-angle zoom position.



✔ Note on Macro Mode Setting



There are functions with which this setting cannot be enabled. See “Camera Settings That cannot be Applied Simultaneously” (📖 76) for more information.

📌 The Macro Mode Setting



- In 📷 (easy auto) mode, the camera enters macro mode when 📷 is selected.
- In scene mode, the setting varies depending on the scene mode (📖 61). The camera enters macro mode when 📷 **Close-up** or 🍴 **Food** is selected.
- In 📷 (smart portrait) mode, macro mode is disabled.

Subject Tracking (Focusing on a Moving Subject)

 (auto) → Tap the bottom tab → Touch shooting

In  (auto) mode ( 51), the touch shooting setting can be changed from **Touch shutter** (default setting) to **Subject tracking**. Use this option to take pictures of moving subjects. Tap the subject on which the camera will focus. The focus area will automatically move to track the subject.

1 Tap (subject tracking).

 (subject tracking) is enabled only in  (auto) mode.

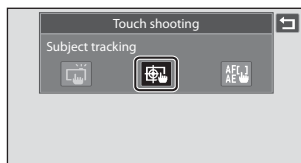

2 Register a subject.

Tap the desired tracking subject in the monitor.

- The subject is registered.
- When the border framing the subject glows red, the camera is unable to focus. Change the composition and try again.

If the tapped area does not contain a subject that can be registered,  will be displayed in the monitor. Tap a subject within .

When the subject is registered, a yellow focus area is displayed around that subject and the camera begins tracking the subject.

Tap another subject to change a subject to follow.

To cancel the registration of the subject, tap  displayed at left in the monitor.

If the camera cannot track the registered subject anymore, the focus area will disappear and the registration will be canceled. Register the subject again.



3 Press the shutter-release button to take a picture.

The camera focuses on the focus area when the shutter-release button is pressed halfway. The focus area will glow green and focus will be locked.





When the camera is unable to focus, the focus area will blink. Press the shutter-release button halfway again to focus.

If the shutter-release button is pressed halfway while the focus area is not displayed, the camera automatically selects one or more of the nine focus areas containing the subject closest to the camera ( 49).

Press the shutter-release button all the way down to release the shutter.



Notes on Subject Tracking Mode

- Digital zoom is not available.
- The sound of the lens focus motor can be heard when the subject tracking function is working.
- Adjust zoom and apply shooting settings ( 53) before selecting the subject. If zoom or any other setting is adjusted after the subject has been registered, subject registration will be cancelled.
- It may be impossible to register the desired subject, or the camera may be unable to track the registered subject or may begin tracking a different subject, if the subject is moving rapidly, if there is a significant amount of camera shake, or if the camera detects a similar subject. The camera's ability to accurately track the registered subject is also dependent upon the size and brightness of the subject.
- In some rare cases, subjects with which autofocus may not perform as expected ( 29) may be out of focus despite the fact that the focus area glows green. In this situation, focus on another subject which is at the same distance from the camera as the intended subject while the shutter-release button is pressed halfway ( 46).
- There are functions with which this setting cannot be enabled. See "Camera Settings That cannot be Applied Simultaneously" ( 76) for more information.

Touch Shooting Setting

Subject registration with subject tracking will be canceled when the camera is turned off.

ISO ISO Sensitivity

 (auto) → Tap the bottom tab → **ISO** ISO sensitivity

Raising the ISO sensitivity reduces the amount of light needed to make an exposure, allowing pictures to be taken in low light conditions. A higher sensitivity also allows for faster shutter speeds, reducing blur caused by subject movement or camera shake.

- High ISO sensitivity settings are useful when taking pictures in dim lighting, when shooting without a flash, or when using the telephoto setting, but they may also produce “noise” -- randomly spaced, brightly colored pixels -- in the dark areas of images.

Auto (default setting)

Sensitivity is ISO 80 when there is sufficient lighting; the camera compensates by raising sensitivity to a maximum of ISO 800 when lighting is poor.



Fixed range auto

Choose the range in which the camera automatically adjusts ISO sensitivity, from **ISO 80-200** or **ISO 80-400**. The camera will not raise sensitivity beyond the maximum value in the selected range. Set the maximum value for ISO sensitivity for effective control over the amount of “grain” that appears in images.



80, 100, 200, 400, 800, 1600, 3200, 6400

Sensitivity is locked at the specified value.

Notes on ISO Sensitivity

- There are functions with which this setting cannot be enabled. See “Camera Settings That cannot be Applied Simultaneously” ( 76) for more information.
- When the ISO sensitivity setting is set to any option other than **Auto**, motion detection ( 50) is disabled.

Notes on ISO Sensitivity 3200 and 6400

- When **ISO sensitivity** is set to **3200** or **6400**, **Image mode** settings are limited to  **2048×1536**,  **1024×768**, and  **640×480**.
- When **ISO sensitivity** is set to **3200** or **6400**, the image mode icon is displayed in red during shooting.

Continuous

 (auto) → Tap the bottom tab →  Continuous

Enable continuous shooting or BSS (best shot selector).

Single (default setting)

One picture is taken each time the shutter-release button is pressed.

Continuous

While the shutter-release button is held down, up to 6 pictures are taken at a rate of about 0.9 frame per second (fps) when **Image mode** is set to  **3968×2232**.

BSS (Best Shot Selector)

The “best shot selector” is recommended when shooting with the flash off or the camera zoomed in, or in other situations in which inadvertent motion can result in blurred pictures. When BSS is on, the camera takes up to ten pictures while the shutter-release button is held down. The sharpest picture in the series is automatically selected and saved.

Multi-shot 16

Each time the shutter-release button is pressed, camera takes 16 pictures at about 7 frames per second (fps) and arranges them in a single image.

- Pictures are recorded at an image mode setting of  (image size: 2560×1920 pixels). This setting cannot be changed.
- Digital zoom is not available.

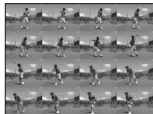

Notes on Continuous Shooting

- When **Continuous**, **BSS**, or **Multi-shot 16** is selected, the flash is disabled. Focus, exposure, and white balance are fixed at the values determined with the first picture in each series.
- The frame rate with continuous shooting may vary depending upon the current image mode setting, the memory card used, or shooting condition.
- There are functions with which this setting cannot be enabled. See “Camera Settings That cannot be Applied Simultaneously” ( 76) for more information.

Note on BSS

BSS is effective when taking pictures of still subjects. BSS may not produce the desired results if the subject moves or the composition changes while the shutter-release button is held down.

Note on Multi-shot 16

Smear ( 168) visible in the monitor when shooting with **Multi-shot 16** enabled will be recorded with images. Avoiding bright objects such as the sun, reflections of the sun, and electric lights when shooting with **Multi-shot 16** enabled is recommended.

WB White Balance (Adjusting Hue)

 (auto) → Tap the bottom tab → WB White balance

The color of light reflected from an object varies with the color of the light source. The human brain is able to adapt to changes in the color of the light source, with the result that white objects appear white whether seen in the shade, direct sunlight, or under incandescent lighting. Digital cameras can mimic this adjustment by processing images according to the color of the light source. This is known as “white balance.” For natural coloration, choose a white balance setting that matches the light source before shooting. Although the default setting, **Auto**, can be used under most types of lighting, the white balance setting suited to a particular light source can be specified manually to achieve more accurate results.

AUTO Auto (default setting)

White balance automatically adjusted to suit lighting conditions. Best choice in most situations.

PRE Preset manual

Neutral-colored object used as reference to set white balance under unusual lighting conditions. See “Preset Manual” for more information ( 60).

Daylight

White balance adjusted for direct sunlight.

Incandescent

Use under incandescent lighting.

Fluorescent

Use under fluorescent lighting.



Cloudy

Use when taking pictures under overcast skies.

Flash

Use with the flash.

Note on White Balance Setting

Turn the flash off (  33) at white balance settings other than **Auto** or **Flash**.

Preset Manual

Preset manual is effective with mixed lighting or to compensate for light sources with a strong color cast (for example, to make pictures taken under a lamp with a red shade look as though they had been taken under white light).

Follow the procedure below to measure the white balance value according to the light source when shooting.

1 Place a white or gray reference object under the lighting that will be used during shooting.

2 Tap the bottom tab to display the settings controls ( 12) and tap **WB**.

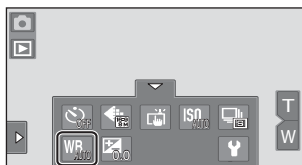

3 Tap **PRE**.

The camera zooms in to the position for measuring white balance.

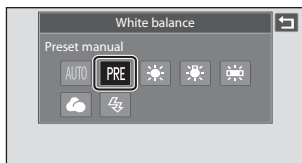

4 Frame the reference object in the measuring window.

To apply the most recently measured value for preset manual, tap **Cancel**.

Measuring window

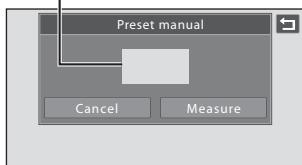

5 Tap **Measure** to measure a value for preset manual.

The shutter is released and the new white balance value is set. No picture is recorded.

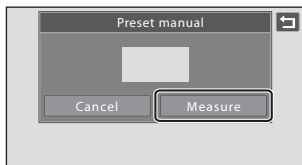

Note on Preset Manual

A value for flash lighting cannot be measured with **Preset manual**. When shooting using the flash, set **White balance** to **Auto** or **Flash**.

Shooting Suited to Scenes (Scene Mode)

Camera settings are automatically optimized for the selected subject type. The following scene modes are available.

Portrait	Landscape	Sports	Night portrait	Party/indoor
Beach	Snow	Sunset	Dusk/dawn	Night landscape
Close-up	Food	Museum	Fireworks show	Copy
Backlighting	Panorama assist			

Selecting a Scene Mode

- 1 Tap the shooting mode icon in shooting mode to display the shooting mode selection menu, and tap .

The scene mode selection screen is displayed.

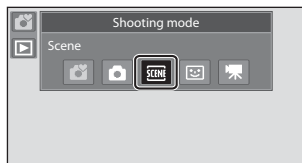

- 2 Tap the desired scene icon.

The camera enters the selected scene mode. See "Selecting a Scene Mode to Take Pictures (Features)" (📖 64) for more information.



- 3 Frame the subject and take a picture.

A scene effect adjustment slider is displayed in some scene modes. The degree of effect applied to pictures taken in the selected scene mode can be adjusted (📖 63).



Displaying the Description of Each Scene Mode

When is tapped in the scene selection screen (step 2), the help selection screen is displayed. Tap a scene icon to display a description of the features of that mode. Tap to return to the help selection screen.

























































- Tap in the help selection screen to return to the monitor display shown in step 2.



Shooting Suited to Scenes (Scene Mode)



Shooting Settings in Scene Mode

The shooting settings for each scene mode are shown below.

	Flash ( 33)	Macro ( 54)	Self-timer ( 36)	Touch shooting ( 41, 44)	Exposure compensation ( 47)
	 ¹	Off	Off ¹	 ^{1,4}	0 ¹
		Off	Off ¹	 ⁵	0 ¹
		Off	Off	 ¹	0 ¹
	 ²	Off	Off ¹	 ^{1,4}	0 ¹
	 ^{1,3}	Off	Off ¹	 ¹	0 ¹
	 ¹ AUTO	Off	Off ¹	 ¹	0 ¹
	 ¹ AUTO	Off	Off ¹	 ¹	0 ¹
	 ¹	Off	Off ¹	 ⁵	0 ¹
		Off	Off ¹	 ⁵	0 ¹
		Off	Off ¹	 ⁵	0 ¹
	 ¹ AUTO	On	Off ¹	 ¹	0 ¹
		On	Off ¹	 ¹	0 ¹
		Off ¹	Off ¹	 ¹	0 ¹
		Off	Off	 ⁵	0
	 ¹	Off ¹	Off ¹	 ¹	0 ¹
		Off	Off ¹	 ¹	0 ¹
	 ¹	Off ¹	Off ¹	 ⁵	0 ¹

- 1 The default setting can be changed by tapping the tabs to display the setting controls.
- 2 The flash mode setting is fixed at fill flash with slow sync with red-eye reduction.
- 3 The setting may change to slow sync with red-eye reduction.
- 4 Only a frame displayed by the face detection function can be selected.
- 5 Focus and exposure are set for the same focus area used when pictures are taken by pressing the shutter-release button.

Image Mode (Image Quality/Image Size) Setting

The image mode ( 38) setting previously specified in other shooting modes (except movie recording) applies. To change the image mode setting in scene mode, tap the bottom tab to display the setting controls and tap .

Adjusting Scene Effect

The scene effect adjustment slider is displayed in the scene modes listed below. Tap or drag the scene effect adjustment slider to adjust the degree of effect to be applied to pictures taken in the selected scene mode.

Scene effect adjustment slider

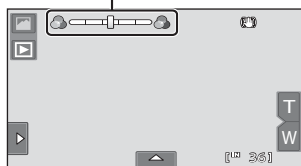

Portrait, Night portrait, Beach, Snow, Night landscape, Backlighting	<p>Darker Brighter</p>
Food	<p>More blue More red</p>
Landscape, Close-up	<p>Less vivid More vivid</p>
Sunset, Dusk/dawn	<p>More blue More red</p>

Selecting a Scene Mode to Take Pictures (Features)

Portrait

Use this mode for portraits.

- When the camera detects a human face, that face will be framed by a yellow double border (focus area). See “Face Detection” (📖 49) for more information.
- If more than one face is detected, the face nearest to the camera will be framed by a yellow double border (focus area) and the other faces will be framed by a single border. Tap the face framed by a single border to change the focus area to that face (📖 41, 44).
- The camera smoothes skin tones (in up to three faces) by applying the skin softening function before recording pictures (📖 73).
- If no faces are detected when the shutter-release button is pressed halfway, the camera focuses on the subject at the center of the frame.
- Digital zoom is not available.
- The default setting for flash mode is  **Auto with red-eye reduction**.
- Use the scene effect adjustment slider (📖 63) to adjust picture brightness.



Landscape

Use this mode for vivid landscapes and cityscapes.

- Camera focuses at infinity. The focus area or focus indicator (📖 28) always glows green when the shutter-release button is pressed halfway. Note, however, that objects in the foreground may not always be in focus.
- The flash does not fire and the flash mode is disabled.
- The AF-assist illuminator does not light (📖 154).
- Use the scene effect adjustment slider (📖 63) to adjust picture saturation.



Sports

Use this mode for dynamic action shots that freeze the action in a single shot and record motion in a series of pictures.

- The camera focuses on the subject at the center of the frame. The area focused can be changed by the touch shutter (📖 41) or touch AF/AE (📖 44).
- While the shutter-release button is held down, up to 6 pictures are taken at a rate of about 0.9 frame per second (fps) when image mode is set to  **3968x2232**.
- Focus, exposure, and white balance are fixed at the values determined with the first picture in each series.
- The frame rate with continuous shooting may vary depending upon the current image mode setting, the memory card used, or shooting condition.
- Continuous shooting is disabled and only one picture can be taken at a time when the shutter is released using the touch shutter function (📖 41).
- The flash does not fire and the flash mode is disabled.
- The AF-assist illuminator does not light (📖 154).



Night portrait



Use this mode for portraits taken at sunset or at night. The flash fires to light the portrait subject while preserving background lighting to achieve a natural balance between the main subject and background ambience.

- When the camera detects a human face, that face will be framed by a yellow double border (focus area). See “Face Detection” (📖 49) for more information.
- If more than one face is detected, the face nearest to the camera will be framed by a yellow double border (focus area) and the other faces will be framed by a single border. Tap the face framed by a single border to change the focus area to that face (📖 41, 44).
- The camera smoothes skin tones (in up to three faces) by applying the skin softening function before recording pictures (📖 73).
- If no faces are detected when the shutter-release button is pressed halfway, the camera focuses on the subject at the center of the frame.
- Digital zoom is not available.
- The flash mode setting is fixed at fill flash with slow sync with red-eye reduction.
- Use the scene effect adjustment slider (📖 63) to adjust picture brightness.



Party/indoor

Captures the effects of candlelight and other indoor background lighting.

- Camera focuses on the subject at the center of the frame. The area focused can be changed by the touch shutter (📖 41) or touch AF/AE (📖 44).
- The default setting for flash mode is  **Auto with red-eye reduction**. The flash mode setting may automatically switch to slow sync with red-eye reduction.
- As pictures are easily affected by camera shake, hold the camera steadily. In dark surroundings, the use of a tripod is recommended. Set **Vibration reduction** (📖 153) to **Off** when using a tripod to stabilize the camera.



Beach

Captures the brightness of such subjects as beaches or sunlit expanses of water.

- Camera focuses on the subject at the center of the frame. The area focused can be changed by the touch shutter (📖 41) or touch AF/AE (📖 44).
- Use the scene effect adjustment slider (📖 63) to adjust picture brightness.



Use of a tripod is recommended in scene modes with which  is indicated. Set **Vibration reduction** (📖 153) to **Off** when using a tripod to stabilize the camera.

Shooting Suited to Scenes (Scene Mode)

Snow

Captures the brightness of such subjects as snowfields.

- Camera focuses on the subject at the center of the frame. The area focused can be changed by the touch shutter (📖 41) or touch AF/AE (📖 44).
- Use the scene effect adjustment slider (📖 63) to adjust picture brightness.



Sunset



Preserves the deep hues seen in sunsets and sunrises.

- Camera focuses on the subject at the center of the frame.
- The default setting for flash mode is  **Off**.
- Use the scene effect adjustment slider (📖 63) to adjust picture color.



Dusk/dawn



Preserves the colors seen in the weak natural light before sunrise or after sunset.

- Camera focuses at infinity. The focus area or focus indicator (📖 28) always glows green when the shutter-release button is pressed halfway. Note, however, that objects in the foreground may not always be in focus.
- The flash does not fire and the flash mode is disabled.
- The AF-assist illuminator does not light (📖 154).
- Use the scene effect adjustment slider (📖 63) to adjust picture color.



Night landscape



Slow shutter speeds are used to produce stunning night landscapes.

- Camera focuses at infinity. The focus area or focus indicator (📖 28) always glows green when the shutter-release button is pressed halfway. Note, however, that objects in the foreground may not always be in focus.
- The flash does not fire and the flash mode is disabled.
- The AF-assist illuminator does not light (📖 154).
- Use the scene effect adjustment slider (📖 63) to adjust picture brightness.



Use of a tripod is recommended in scene modes with which  is indicated. Set **Vibration reduction** (📖 153) to **Off** when using a tripod to stabilize the camera.

🌸 Close-up

Photograph flowers, insects and other small objects at close range.

- Macro mode (📖 54) is enabled and the camera automatically zooms to the closest position at which it can focus.
- The closest possible shooting distance may vary according to zoom position. The camera can focus at a closer distance when 📷 and the zoom indicator glow green and the zoom indicator is positioned below ▷ (wide-angle position). The camera can focus on the subject as close as 7 cm (2.8 in.) at the maximum wide-angle zoom position.
- Note that the flash may be unable to light entire subject at distances of less than 50 cm (1 ft. 8 in.).
- Camera focuses on the subject at the center of the frame. The area focused can be changed by the touch shutter (📖 41) or touch AF/AE (📖 44).
- As pictures are easily affected by camera shake, be sure that **Vibration reduction** (📖 153) is enabled and hold the camera steadily.
- Use the scene effect adjustment slider (📖 63) to adjust picture saturation.



🍴 Food

Use when taking pictures of food.







- Macro mode (📖 54) is enabled and the camera automatically zooms to the closest position at which it can focus.
- The closest possible shooting distance may vary according to zoom position. The camera can focus at a closer distance when 📷 and the zoom indicator glow green and the zoom indicator is positioned below ▷ (wide-angle position). The camera can focus on the subject as close as 7 cm (2.8 in.) at the maximum wide-angle zoom position.
- The flash does not fire and the flash mode is disabled.
- Camera focuses on the subject at the center of the frame. The area focused can be changed by the touch shutter (📖 41) or touch AF/AE (📖 44).
- As pictures are easily affected by camera shake, be sure that **Vibration reduction** (📖 153) is enabled and hold the camera steadily.
- Use the scene effect adjustment slider to adjust the influence lighting has on the color of the subject (📖 63). Scene effect adjustments applied in **Food** scene mode are stored in the camera's memory even after the camera is turned off.



Shooting Suited to Scenes (Scene Mode)

Museum

Use indoors where flash photography is prohibited (for example, in museums and art galleries) or in other situations in which you do not want to use the flash.



- Camera focuses on the subject at the center of the frame. The area focused can be changed by the touch shutter ( 41) or touch AF/AE ( 44).
- BSS (best shot selector) ( 58) can be enabled when shooting.
- BSS is disabled and only one picture can be taken at a time when the shutter is released using the touch shutter function ( 41).
- As pictures are easily affected by camera shake, be sure that **Vibration reduction** ( 153) is enabled and hold the camera steadily.
- The flash does not fire and the flash mode is disabled.
- The AF-assist illuminator does not light ( 154).



Fireworks show







Slow shutter speeds are used to capture the expanding burst of light from a firework.

- Camera focuses at infinity. The focus area or focus indicator ( 28) always glows green when the shutter-release button is pressed halfway. Note, however, that objects in the foreground may not always be in focus.
- The flash does not fire and the flash mode is disabled.
- The AF-assist illuminator does not light ( 154).





Copy

Provides clear pictures of text or drawings on a white board or in print.

- Camera focuses on the subject at the center of the frame. The area focused can be changed by the touch shutter ( 41) or touch AF/AE ( 44).
- Use macro mode ( 54) to focus at short ranges.
- Colored text and drawings may not show up well.
- The default setting for flash mode is  **Off**.



Use of a tripod is recommended in scene modes with which  is indicated. Set **Vibration reduction** ( 153) to **Off** when using a tripod to stabilize the camera.

Backlighting

Use when light is coming from behind the subject, throwing features or details into shadow. The flash fires automatically to “fill in” (illuminate) shadows.

- Camera focuses on the subject at the center of the frame. The area focused can be changed by the touch shutter ( 41) or touch AF/AE ( 44).
- The flash mode setting is fixed at  **Fill flash**.
- Use the scene effect adjustment slider ( 63) to adjust picture brightness.



Panorama assist



Use when taking a series of pictures that will later be joined to form a single panorama using the supplied Panorama Maker 5 software. See “Shooting for a Panorama” ( 70) for more information.

- The default setting for flash mode is  **Off**.

Shooting for a Panorama

The camera focuses on the subject at the center of the frame. Use a tripod for best results. Set **Vibration reduction** (📖 153) to **Off** from the setup menu (📖 145) when using a tripod to stabilize the camera.

- 1 Tap the shooting mode icon in shooting mode to display the shooting mode selection menu, and tap **SCENE**.

The scene mode selection screen is displayed.

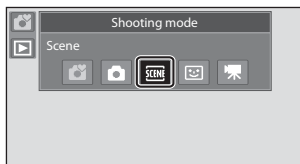

- 2 Tap **📐 Panorama assist**.

The panorama direction icons are displayed to show the direction in which pictures will be joined.

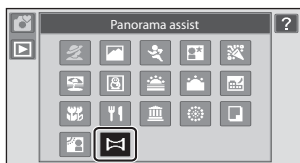

- 3 Tap a direction icon.

Select the direction in which picture will be joined in the completed panorama; right (▶), left (◀), up (▲), or down (▼).

A different direction can be selected by tapping a different panorama direction icon.

Change shooting settings (📖 53) before the first picture is taken in the next step.



- 4 Frame the first portion of the panorama scene and take the first picture.

One third of the picture will be displayed as translucent.



5 Take the next picture.

Frame the next picture so that one-third of the frame overlaps the previous picture.

Repeat this process until the necessary number of pictures have been taken to complete the scene.



6 Tap X when shooting is completed.

The camera returns to step 3.



Notes on Panorama Assist

- Apply or adjust shooting settings (📖 62) before releasing the shutter for the first picture. Shooting settings cannot be changed after the first picture is taken. Picture cannot be deleted, nor can zoom be adjusted until the series is finalized.
- The panorama series is terminated if the camera enters standby mode with the auto off function (📖 155) during shooting. Setting the time allowed to elapse before the auto off function is enabled to a longer setting is recommended.

AE/AF-L Indicator

In **Panorama assist** scene mode, exposure, white balance, and focus for all pictures in a panorama are fixed at the values for the first picture in each series. When the first picture is taken, AE/AF-L is displayed to indicate that exposure, white balance, and focus are locked.



Panorama Maker 5

Install Panorama Maker 5 from the supplied ViewNX 2 CD-ROM.

Transfer pictures to a computer (📖 132) and use Panorama Maker 5 (📖 136) to join them in a single panorama.

More Information

See "Image/Sound File and Folder Names" (📖 171) for more information.

Shooting Smiling Faces (Smart Portrait Mode)

At the default settings, the camera uses face detection to detect human faces, and then automatically releases the shutter when a smile is detected (smile timer). The skin softening option can be used to smooth skin tones of human faces.

- 1 Tap the shooting mode icon in shooting mode to display the shooting mode selection menu, and then tap .

The camera enters smart portrait mode.

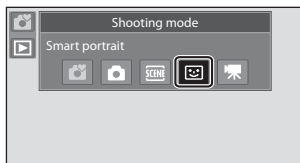

- 2 Frame a picture.

Point the camera at the subject.

When the camera detects a human face, a yellow double border (focus area) is displayed around that face. When focus is acquired on that face, the double border will turn green for a moment and focus is locked.

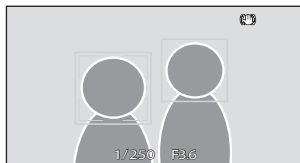

Up to three faces can be detected. When the camera detects more than one face, the double border is displayed around the face closest to the center of the frame, and single borders around the others.

Tap the face framed by a single border to move the focus area to that face.

- 3 The shutter is automatically released.

If the camera detects that the face framed by the double border is smiling, **Smile timer** (📖 75) is activated and the shutter is automatically released.

Each time the shutter is released, the camera again initiates face detection and smile detection operations for continuous automatic shooting.

- 4 Shooting ends.

To stop automatic shooting of smiling faces, either turn the camera off, set **Smile timer** to **Off**, or tap the shooting mode icon and select another shooting mode.

 **Notes on Smart Portrait Mode**

- Digital zoom is not available.
- Self-timer is not available.
- Touch shutter cannot be enabled.
- Under some shooting conditions, the camera may be unable to detect faces or detect smiles.
- See “Notes on Face Detection” (📖 49) for more information.

 **Notes on Skin Softening**

- More time than usual may be required to save a picture when shooting with skin softening function.
- In some shooting conditions, facial skin tones may not be smoothed or parts other than face may be modified though the camera detects a face. If the desired results are not produced, set **Skin softening** to **Off** and shoot again.
- The skin softening level cannot be adjusted when the portrait or night portrait is selected in the scene mode.
- Retouch effects such as the glamour retouch function’s skin softening effect can be applied to pictures after they are taken (📖 120).

 **Self-timer Lamp**

The self-timer lamp blinks slowly when the smile timer is enabled and the camera detects a face, and it blinks quickly immediately after the shutter is released.

 **Releasing the Shutter Manually**

Pictures can also be taken by pressing the shutter-release button. The camera focuses on the subject at the center of the frame when faces are not detected.

 **Auto Off in Smile Timer Mode**

When **Smile timer** is set to **On**, the auto off function (📖 155) is activated and the camera turns off when either of the situations indicated below persists and no other operations are performed.

- The camera does not detect any faces.
- The camera detected a face, but cannot detect a smile.

 **More Information**

See “Autofocus” (📖 29) for more information.

Changing the Smart Portrait Mode Settings

The settings indicated below can be made by tapping the tabs to display the setting controls in smart portrait mode.

- Each icon also indicates the current setting.
- Tap the icon of the desired item to display the setting screen for that item.
- To hide the setting controls, tap the tab again.

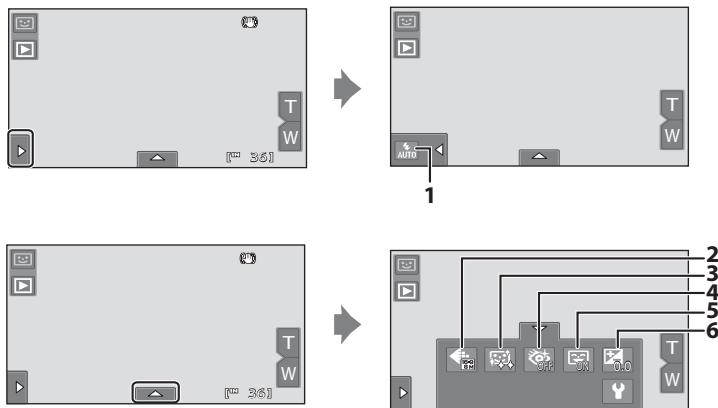

1 Flash mode

Set the flash mode ( 33) when taking pictures in smart portrait mode.

2 Image mode

Adjust **Image mode** ( 38).

Changes made to the image mode setting apply to all shooting modes (except movie recording).

3 Skin softening

Enable skin softening. When the shutter is released, the camera detects one or more human faces (up to three), and processes the image to soften facial skin tones before saving the picture.



The degree of skin softening applied can be selected from **High**, **Normal** (default setting), and **Low**. When **Off** is selected, the skin softening function is disabled.

- The effects of skin softening are not visible when framing pictures for shooting. Check the degree of skin softening performed in playback mode.

4  Blink proof

When **On** is selected, the camera automatically releases the shutter twice each time a picture is taken. Of the two shots, one in which the subject's eyes are open is saved.

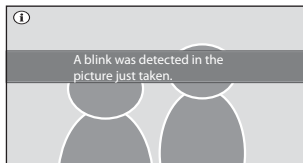
- If the camera saved a picture in which the subject's eyes may have been closed, the dialog shown at right is displayed for a few seconds.
- When **On** is selected, the flash is disabled.
- The default setting is **Off**.

5  Smile timer

- **On** (default setting): The camera uses face detection to detect a human face, and then automatically releases the shutter whenever a smile is detected.
- **Off**: The camera does not release the shutter automatically with smile detection. Press the shutter-release button to take a picture.

6  Exposure compensation

Adjust **Exposure compensation** ( 47) with shooting in smart portrait mode.

 **Settings in Smart Portrait Mode**

There are functions with which this setting cannot be enabled. See “Camera Settings That cannot be Applied Simultaneously” ( 76) for more information.

Camera Settings That cannot be Applied Simultaneously



Some shooting settings cannot be used with other functions.

Restricted function	Setting	Description
Flash mode (📖 33)	Continuous (📖 58)	When Continuous , BSS , or Multi-shot 16 is selected, flash is disabled.
	Blink proof (📖 75)	When Blink proof is set to On , flash is disabled.
Self-timer (📖 36)	Subject tracking (📖 55)	When Touch shooting is set to Subject tracking , Self-timer is disabled.
Image mode (📖 38)	Continuous (📖 58)	When Multi-shot 16 is selected, the Image mode setting is fixed at SM (image size: 2560×1920 pixels).
	ISO sensitivity (📖 57)	When 3200 or 6400 is selected for ISO sensitivity , the Image mode setting of only SM 2048×1536 , PC 1024×768 , or VGA 640×480 can be selected. If any image mode setting other than above is selected, the image mode setting is automatically changed to SM 2048×1536 when ISO sensitivity is set to 3200 or 6400 .
Macro mode (📖 54)	Subject tracking (📖 55)	When Touch shooting is set to Subject tracking , Macro mode is disabled.
ISO sensitivity (📖 57)	Continuous (📖 58)	When Multi-shot 16 is selected, the ISO sensitivity setting is automatically specified according to the brightness.
Continuous (📖 58)	Self-timer (📖 36)	When taking a picture using the self-timer, the continuous setting is fixed to Single .
	Touch shutter (📖 41)	When using the touch shutter function, one picture is taken each time the monitor is tapped.
Blink warning (📖 159)	Continuous (📖 58)	When taking a picture using Continuous , BSS , or Multi-shot 16 , Blink warning is disabled.
Date imprint (📖 152)	Continuous (📖 58)	When Continuous or BSS is selected for the Continuous setting, date imprint is disabled.
	Blink proof (📖 75)	When On is selected, Date imprint is disabled.

Restricted function	Setting	Description
Digital zoom (📖 27)	Continuous (📖 58)	When Multi-shot 16 is selected, digital zoom is not available.
	Subject tracking (📖 55)	When the touch shooting is set to Subject tracking , digital zoom is disabled.

Restricted Functions in Shooting Mode

The restricted functions vary with the shooting mode (📖 48). See the following pages for details on the functions available in each shooting mode:

-  (easy auto) mode →📖 32
-  (auto) mode →📖 53
- Scene mode →📖 62
- Smart portrait mode →📖 74
- Movie →📖 126

More Information

See “Notes on Digital Zoom” (📖 154) for more information.

Operations in Full-frame Playback Mode

Tap the playback icon (▶) at the upper left in the monitor in shooting mode to enter playback mode and display pictures that have been taken (📖 30).

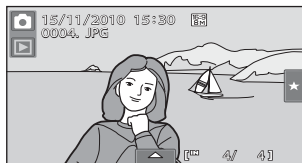

The following operations are available in full-frame playback mode.

To	Tap	Description	📖
Select a picture	–	Drag the picture to the right to display the previous picture and to the left to display the subsequent picture. Drag the picture with two fingers to scroll ahead or back ten pictures at a time.	6, 30
View thumbnails	–	Display 4, 9, or 16 picture thumbnails. Picture thumbnails can be displayed by placing two fingers on the picture currently displayed and pinching them together.	79
Zoom in	–	Enlarge view of picture currently displayed in the monitor up to about 10x. Pictures can be enlarged by placing two fingers on the picture currently displayed and spreading them apart. Tap ✕ to return to full-frame playback.	81
Play back movies	▶	Tap ▶ to play back the movie currently displayed.	128
Set the picture rating/ play back pictures by rating	Right tab (★)	Apply a rating of one to five to each picture or play back pictures by rating.	97
Make playback settings	Bottom tab	Specify the playback settings and edit pictures.	96
Switch to another playback mode	Playback mode icon	Tap the playback mode icon to display the playback mode selection menu and change to favorite pictures, auto sort, or list by date mode.	83
Switch to shooting mode	Shooting mode icon	Tap the shooting mode icon displayed at upper left in the monitor. The shutter-release button can also be pressed to switch to shooting mode.	–

Picture Orientation (Portrait or Landscape)

Pictures taken in portrait (“tall”) orientation will be rotated automatically (📖 11). The rotating direction can be changed from the **Rotate image** option (📖 106). When the camera is rotated, the picture displayed is also rotated (📖 11).

Viewing Multiple Pictures: Thumbnail Playback

Placing two fingers on the monitor in full-frame playback mode (📖 78) and pinching them together displays pictures in “contact sheets” of thumbnail images.

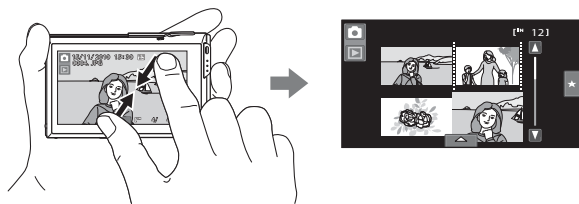

The following operations can be performed while thumbnails are displayed.

To	Tap	Description	📖
Increase number of picture thumbnails displayed	–	Increase number of picture thumbnails displayed: 4 → 9 → 16 Placing two fingers on the picture currently displayed and pinching them together increases the number of picture thumbnails displayed.	–
Decrease number of picture thumbnails displayed	–	Decrease number of picture thumbnails displayed: 16 → 9 → 4 Placing two fingers on the picture currently displayed and spreading them apart decreases the number of picture thumbnails displayed.	–
Scroll display	▲ ▼	Tap ▲ or ▼, or drag the slider at the right of the monitor. Dragging your finger up and down on the monitor can also scroll through the display.	–
Return to full-frame playback	–	Tap a picture.	–
Set the picture rating/play back pictures by rating	Right tab (★)	Apply a rating of one to five to each picture or play back pictures by rating.	97
Make playback settings	Bottom tab	The Delete , Slide show , Protect , or Print set setting can be enabled.	96
Switch to shooting mode	Shooting mode icon	Tap the shooting mode icon or press the shutter-release button.	–

Viewing Multiple Pictures: Thumbnail Playback

Thumbnail Playback Mode Display

Pictures with ratings (📖 97) and protected pictures (🔒 100) are displayed with the icons shown at right. Movies are displayed as film frames.

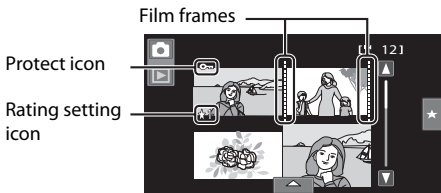

Thumbnail Display in Favorite Pictures and Auto Sort Mode

- When thumbnails are displayed in favorite pictures mode (📖 84), the favorite pictures icon is displayed in the monitor.



- When thumbnails are displayed in auto sort mode (📖 91), the pictures' category icon is displayed in the monitor.



Taking a Closer Look: Playback Zoom

Placing two fingers on the monitor in full-frame playback mode (📖 78) and spreading them apart enlarges display of the current picture.

- The guide displayed in the bottom right of the monitor shows the portion of the image currently displayed.

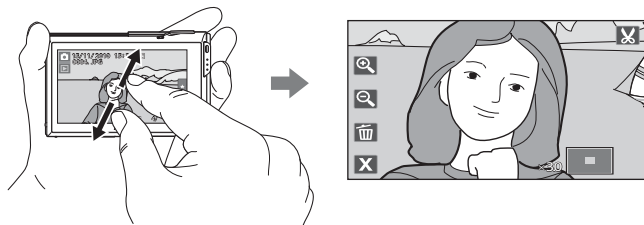

The following operations can be performed while picture display is enlarged.

To	Tap	Description	📖
Zoom in	🔍	Tap 🔍 to enlarge view of picture currently displayed in monitor, up to about 10x. Pictures can also be zoomed in by placing two fingers on the picture currently displayed and spreading them apart.	–
Zoom out	🔍	Tap 🔍. When the magnification ratio reaches 1x, the display returns to full-frame playback mode. Pictures can also be zoomed out by placing two fingers on the picture currently displayed and pinching them together.	–
Change the display area	–	The area of the picture currently displayed can be changed by dragging the picture.	–
Delete pictures	🗑️	Tap 🗑️.	31
Switch to full-frame playback	✕	Tap ✕.	78
Create a cropped copy (crop)	✂️	Crop the enlarged portion of the image and save it as a separate file.	123
Switch to shooting mode	–	Press the shutter-release button.	–

Pictures Taken with Face Detection Function





When zooming in (playback zoom) on a picture taken with the face detection function (📖 26) by placing two fingers on the monitor and spreading them apart (📖 81) in full-frame playback mode, the picture will be enlarged with the face detected with shooting at the center of the monitor (except pictures taken with **Continuous**, **BSS**, or **Multi-shot 16** (📖 58)).



- If more than one face was detected, the picture will be enlarged with the face on which focus was acquired at the center of the monitor. Tap 📷 or 📷 to display other detected faces.
- When 🔍 or 🔍 is tapped to adjust the zoom ratio, the center of the picture (normal playback zoom display), rather than the face, is displayed at the center of the monitor.

Selecting Playback Mode

The following playback modes can be selected.

 Playback mode 📖 30
Play back all pictures.
 Favorite pictures mode 📖 84
Play back pictures added to albums.
 Auto sort mode 📖 91
Play back pictures and movies automatically sorted to the selected category with shooting.
 List by date mode 📖 94
Play back pictures taken on the selected date.

1 Tap the playback mode icon in playback mode.

The playback mode selection menu is displayed.

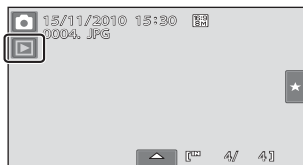

2 Tap the desired playback mode icon.

The camera enters the selected playback mode.

To return to the current playback mode, tap the playback mode icon at the upper left in the monitor.

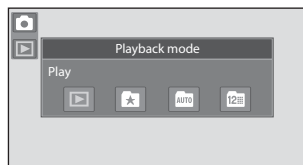

Sorting Favorite Pictures (Favorite Pictures Mode)

Pictures can be sorted to albums. Once pictures have been sorted to albums, favorite picture mode can be used to play back only the pictures in a specific album. Adding pictures to albums makes finding a particular picture faster and easier. Pictures can be sorted to albums categorized by themes such as travel or weddings. A single picture can be added to multiple albums.

Adding Pictures to Albums

Pictures can be sorted by adding them to albums.

1 Play back pictures in playback mode (📖 30), auto sort mode (📖 91), or list by date mode (📖 94).

2 Select a desired picture and tap the bottom tab.

Display the picture in full-frame playback mode and tap the bottom tab.

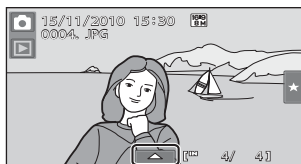

3 Tap .

The favorite pictures screen is displayed.





4 Tap the desired album.

The picture is added to the selected album and monitor display returns to full-frame playback mode.

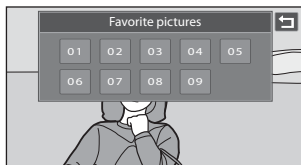
Repeat steps 1 and 2 to add a picture to multiple albums.



Notes on Adding Favorite Pictures

- An album can contain up to 200 pictures.
- Movies cannot be added to albums.
- If the selected picture has already been added to an album, the album icon turns yellow.
- When pictures are added to albums, they are not physically copied to albums or moved from the folder ( 171) to which they were originally recorded ( 90).

More Information

See "Removing Pictures from Albums" ( 87) for more information.

Viewing Pictures in an Album

Pictures can be displayed by selecting the album to which they were added in “★ favorite pictures mode”.

- In full-frame playback mode, just as with normal playback mode, picture display can be enlarged, or pictures can be displayed as thumbnails. When the bottom tab is tapped to display the setting controls, settings can be made and editing can be performed on pictures sorted to the specified album (📖 96).

- 1 Tap the playback mode icon in playback mode to display the playback mode selection menu (📖 83), and tap ★.

A list of albums is displayed.

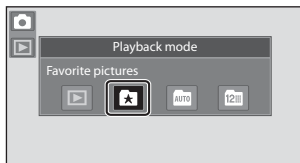

- 2 Tap the desired album.

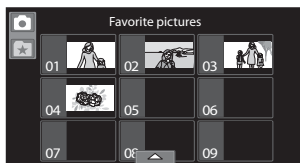

The picture in the selected album will be displayed in full-frame playback mode.

The icon for the current album is displayed on the screen.

Repeat steps 1 and 2 to select a different album.



Removing Pictures from Albums

To remove a picture from an album without permanently deleting it, follow the procedures described below.

- Select the desired picture in full-frame display in step 2 in favorite pictures mode (86), tap the bottom tab to display the setting controls, and then tap . The confirmation dialog is displayed.
- Tap **Yes** to remove the picture from the album. To exit without removing the picture, tap **No**.

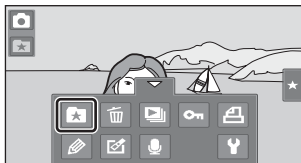







Note on Deleting Picture in Favorite Pictures Mode

Note that deleting a picture played back in favorite picture mode permanently deletes the original picture from the internal memory or memory card (89).

Operations in Favorite Pictures Mode

The following operations are available with display of album list.

To	Tap	Description	
Change the album icon		Tap the bottom tab to display the setting controls, and tap  .	89
Delete all pictures in the selected album		When the bottom tab is tapped to display the setting controls, and  is tapped, the album selection screen is displayed. Select the desired album and tap OK .	—
Switch to another playback mode		Display the playback mode selection menu.	83
Switch to shooting mode	Shooting mode icon	Tap the shooting mode icon displayed at upper left in the monitor or press the shutter-release button.	—

Changing Icons Assigned to Albums

The icon assigned to an album can be changed to reflect the theme of pictures included in the album.

- 1 Tap the playback mode icon in playback mode to display the playback mode selection menu (83), and tap .

Album list is displayed.

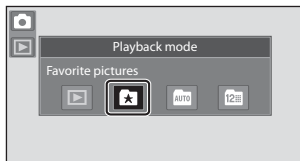

- 2 Tap the bottom tab to display the setting controls and tap .

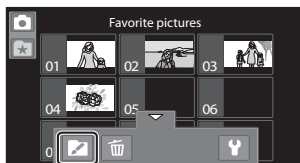

- 3 Tap the desired album.

The album icon and icon color selection screen is displayed.

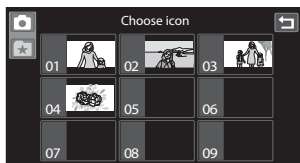

- 4 Tap the desired icon to be assigned to an album, tap or drag the slider to select the icon's color, and tap **OK**.

The icon is changed and monitor display returns to the display of album list.

To return to the album selection screen without adjusting the settings, tap .

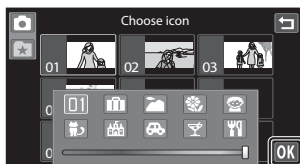

Notes on Icons for Albums

Choose icons for albums separately for the internal memory and for every memory card used.

- To change the icon for an album containing pictures stored in the internal memory, remove the memory card from the camera.
- The default setting for icons are numbers.

Sorting Favorite Pictures (Favorite Pictures Mode)

Adding/Viewing Favorite Pictures

When pictures are added to an album, they are not physically copied to the album or moved from the folder to which they were originally recorded (📖 171). Only the file names of pictures are added to albums. In favorite pictures mode, pictures with file names that have been added to the specified album are played back.

Note that deleting a picture played back in favorite picture mode (📖 31, 88) permanently deletes the original picture from the internal memory or memory card.

Adding Pictures to Albums

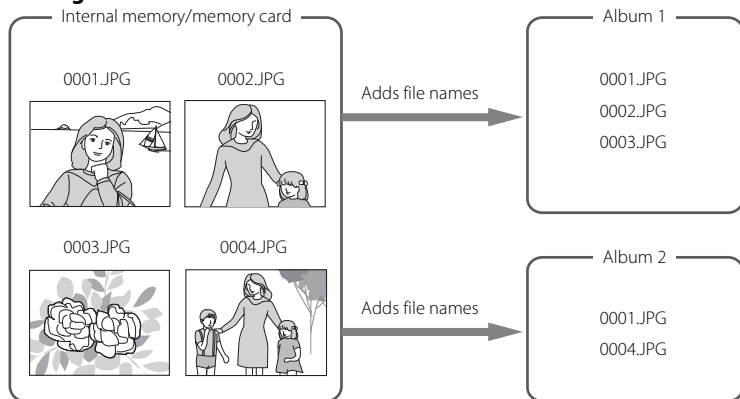





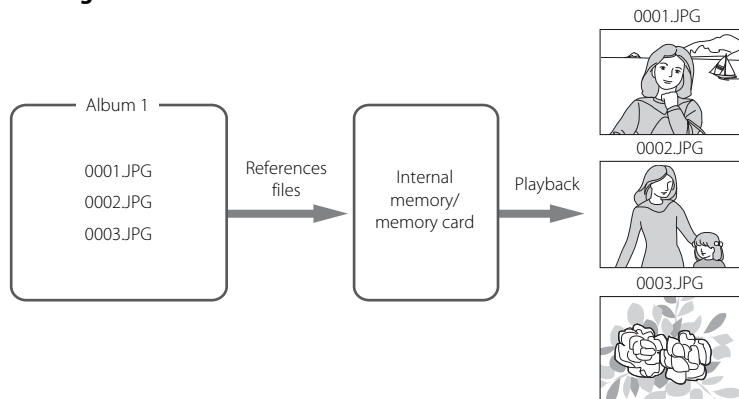



More on Playback

Viewing Pictures in Albums



Finding Pictures in Auto Sort Mode

When shooting pictures and movies, they are automatically sorted to one of the categories shown below. If “**AUTO** auto sort mode” is selected, pictures and movies can be viewed by selecting the category to which they were sorted.

 Smile	 Portraits	 Food
 Landscape	 Dusk to dawn	 Close-ups
 Movie	 Retouched copies	 Other scenes

- In full-frame playback mode, just as with normal playback mode, picture display can be enlarged, pictures can be displayed as thumbnails, and movies can be played back. When the bottom tab is tapped to display the setting controls, settings can be made and editing can be performed on pictures sorted to the specified category (📖 96).

Viewing Pictures in Auto Sort Mode

- 1 Tap the playback mode icon in playback mode to display the playback mode selection menu (📖 83), and then tap **AUTO**.

Category list is displayed.

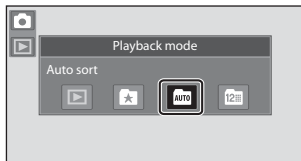

- 2 Tap the desired category.

For more information on categories, see “Auto Sort Mode Categories” (📖 92).







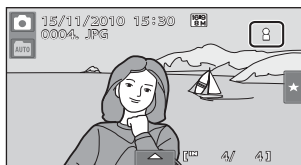
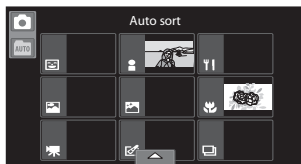



The picture in the selected category will be displayed in full-frame playback mode.

The icon for the category currently selected is displayed.

Repeat steps 1 and 2 to select a different category.



Auto Sort Mode Categories

Category	Description
 Smile	Pictures taken in smart portrait mode (📖 72) with the smile timer setting set to On are displayed.
 Portraits	Pictures taken in  (auto) mode (📖 51) with the face detection. Pictures taken in Portrait* , Night Portrait* , Party/indoor , and Backlighting* scene modes (📖 61). Pictures taken in smart portrait mode (📖 72) with the smile timer setting set to Off .
 Food	Pictures taken in Food scene mode (📖 61).
 Landscape	Pictures taken in Landscape* scene mode (📖 61).
 Dusk to dawn	Pictures taken in Night landscape* , Sunset , Dusk/dawn , and Fireworks show scene modes (📖 61).
 Close-ups	Pictures taken in  (auto) mode with the macro mode setting (📖 54). Pictures taken in Close-up* scene mode (📖 61).
 Movie	Movies (📖 124).
 Retouched copies	Copies created using editing functions (📖 109).
 Other scenes	All other pictures that cannot be defined by the categories described above.





* Pictures taken in  (easy auto) mode (📖 49) are also sorted to the appropriate categories.

Notes on Auto Sort Mode

- Up to 999 pictures and movie files can be sorted to each category in auto sort mode. If 999 pictures or movies have already been sorted to a specific category, new pictures and movies cannot be sorted to that category nor can they be displayed in auto sort mode. Display pictures and movies that could not be sorted to a category in normal playback mode (📖 30) or list by date mode (📖 94).
- Pictures or movies copied from the internal memory or the memory card or vice versa (📖 164) cannot be displayed in auto sort mode.
- Pictures or movies recorded by a camera other than the COOLPIX S80 cannot be displayed in auto sort mode.

Operations in Auto Sort Mode

The following operations are available with display of category list.



To	Tap	Description	
Delete all pictures in the selected category		When the bottom tab is tapped to display the setting controls, and  is tapped, the category selection screen is displayed. Select the desired category and tap OK .	–
Switch to another playback mode		Display the playback mode selection menu.	83
Switch to shooting mode	Shooting mode icon	Tap the shooting mode icon displayed at the upper left in the monitor or press the shutter-release button.	–

Selecting Pictures Taken on a Specific Day (List by Date Mode)

In “ list by date mode”, pictures taken on a same date can be played back.

- In full-frame playback mode, just as with normal playback mode, picture display can be enlarged, pictures can be displayed as thumbnails, and movies can be played back. When the bottom tab is tapped to display the setting controls, settings can be made and editing can be performed on pictures taken on a specific day ( 96).

Selecting a Date in List by Date Mode

- 1 Tap the playback mode icon in playback mode to display the playback mode selection menu ( 83), and tap .

Dates for which pictures exist are listed.

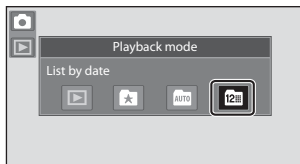

- 2 Tap the desired date.

To change the displayed month, tap  or .

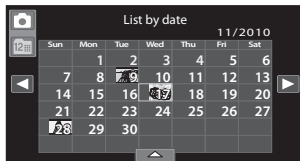

The first picture taken on the selected date will be displayed full frame.

Repeat step 1 and 2 to select a different date.

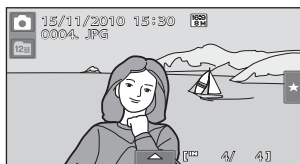









Notes on List by Date Mode

- Up to 9,000 of the most recently recorded pictures can be displayed in list by date mode.
- Pictures taken before the date and time have been set are recognized as having been taken on “01/01/2010.”

Operations in List by Date Mode

The following operations are available in the shooting date selection screen.

To	Tap	Description	
Change the month	 	Tap  or  .	–
Delete all pictures in the selected date		When the bottom tab is tapped to display the setting controls, and  is tapped, the date selection screen is displayed. Select the desired date and tap  .	–
Switch to another playback mode		Display the playback mode selection menu.	83
Switch to shooting mode	Shooting mode icon	Tap the shooting mode icon displayed at the upper left in the monitor or press the shutter-release button.	–

Playback Options

To adjust picture settings or edit pictures, tap the tab in full-frame playback mode to display the setting controls.

- The controls available and monitor display vary depending upon the current picture and camera settings.
- Tap the icon of the desired item to display the setting screen for that item.
- To hide the setting controls, tap the tab again.

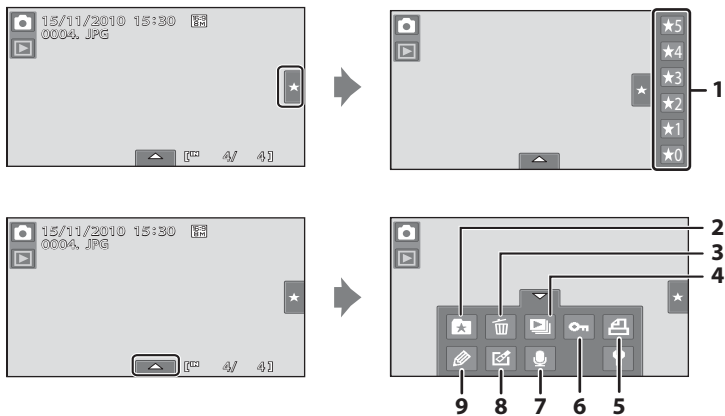

More on Playback

1	Ratings*	97	5	DPOF print order*	102
2	Add pictures to albums (except in favorite pictures mode)	84	6	Protect*	100
	Remove pictures from albums (in favorite pictures mode)	87	7	Voice memo	107
3	Delete *	31	8	Retouch	109
4	Slide show*	98	9	Rotate image	106
				Paint	111

* This function can also be performed in thumbnail playback mode. If the camera is switched to thumbnail playback mode while pictures are played back in favorite pictures, auto sort, or list by date mode, this function can be performed only on the pictures sorted to the selected folder, category or date.

Setting the Picture Rating

A rating of one to five can be assigned to each picture. It is also possible to play back only the pictures that have been assigned a specific rating.

- 1 Tap the right tab in full-frame playback (📖 78) or thumbnail playback (📖 79) mode.

See "Opening the Tabs" (📖 12) for more information.



- 2 Drag and drop (📖 7) the desired rating icon onto the picture.

Rating is applied.

Drag and drop another icon to change the rating.

Drag and drop ★0 to cancel the rating.

A picture's rating can be confirmed by the number of ★ shown in full-frame playback mode.

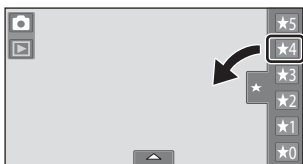

Playing Back Pictures by Rating

- 1 Tap the right tab in full-frame playback (📖 78) or thumbnail playback (📖 79) mode.

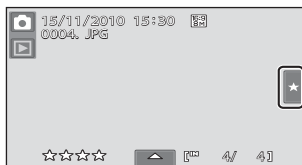

- 2 Tap a rating icon to display the pictures with that rating.

The icon of the tapped rating turns yellow, and only the pictures assigned with the selected rating are displayed. Multiple ratings can be selected.

To stop displaying pictures of a selected rating, tap the icon of the rating to deselect it. To stop playback by rating, deselect all ratings.

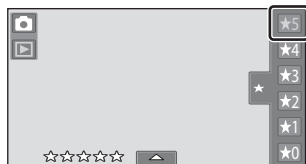

Notes on the Rating

- Each rating can be applied to a maximum of 999 pictures.
- Rating cannot be applied to movies.
- The ratings applied on the COOLPIX S80 are not recognized by your computer.

Enjoying Slide Shows

Play back pictures, stored in the internal memory or on a memory card, one by one in an automated “slide show.”

- 1 Tap the bottom tab in playback mode to display the setting controls, and tap .

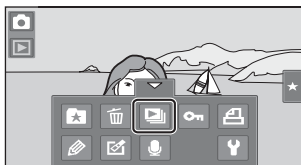

- 2 Tap **Start**.

To change the effects, tap **Effects** before selecting **Start**, and select from **Classic** or **Zoom**.

To repeat the slide show automatically, enable **Loop** by tapping **Loop** before tapping **Start**. A check mark (✓) will be added to the loop option when enabled.

Tap  to play back sample images stored in the camera with an automatic loop function.

To exit without playing back pictures in a slide show, tap .









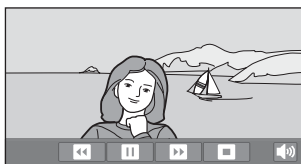

- 3 The slide show begins.

Tap the monitor to display the operation panel at the bottom of the screen.

Tap the icons in the operation panel to perform the corresponding operations. The following operations are available.





To	Tap	Description
Adjust volume		Adjust the volume of background music.
Rewind		Tap and hold  to rewind slide show.
Advance		Tap and hold  to advance slide show.
Pause		Pause playback. <ul style="list-style-type: none">• To resume playback, tap  displayed at the center of the frame.
End		End slide show.

 **Notes on Slide Show**

- Only the first frame of movies included in a slide show is displayed.
- The maximum playback time is up to 30 minutes even if **Loop** is enabled ( 155).

Protecting Important Pictures (Protect)

Protect selected pictures from accidental deletion. Protected pictures are recognized by the  icon in playback mode ( 10, 80).

Protecting One Picture

- 1 Select the desired picture to be protected in full-frame playback mode, and tap the bottom tab.



- 2 Tap .



- 3 Tap **On**.

The selected picture is protected.

To exit without protecting pictures, tap .



Note on Protecting Pictures

Note that formatting the camera's internal memory or the memory card will permanently delete protected files ( 156).

Protecting Multiple Pictures

Multiple pictures can be protected at a time.

- 1 Switch to thumbnail playback mode (📖 79), tap the bottom tab to display the setting controls, and then tap **Protect**.

The monitor display switches to the picture selection screen for protection.



- 2 Tap the desired pictures to be protected.

When a picture is selected, a check mark is displayed. To cancel the selection, tap the picture again.

Tap **2** or **3** to change the number of pictures displayed.

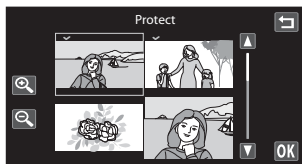

- 3 Tap **OK**.

The selected pictures are protected.

To exit without protecting pictures, tap **Cancel**.

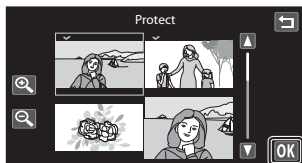



Removing Protection from Pictures

- To remove protection from a picture, display a protected picture in full-frame playback mode, follow the procedure in "Protecting One Picture" (📖 100), and tap **Off** in step 3.
- To remove protection from multiple pictures at a time, uncheck protected pictures in step 2 of "Protecting Multiple Pictures".

Creating a DPOF Print Order: Print Set

When printing pictures stored on the memory card using any of the following methods, the **Print set** option in the playback menu is used to create digital “print orders” for printing on DPOF-compatible devices.

- Inserting the memory card into a DPOF-compatible ( 187) printer’s card slot
- Taking the memory card to a digital photo lab
- Connecting the camera to a PictBridge-compatible ( 187) printer ( 138). A print order can also be created for pictures stored in the internal memory if the memory card is removed from the camera

Creating a Print Order for One Picture

- 1 Select the desired picture in full-frame playback mode and tap the bottom tab.

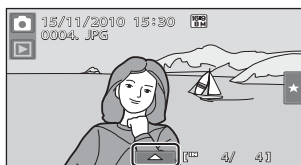

- 2 Tap .

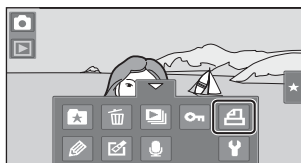

- 3 Tap the desired number of copies and tap **OK**.

To exit without making the print setting, tap .



If the total number of the pictures in a print order, including pictures just added, exceeds 99, the screen shown at right will be displayed.

- Tap **Yes** to remove pictures previously added from the print order and restrict the print order to pictures just marked.
- Tap **Cancel** to remove the pictures just added from the print order and restrict the print order to pictures previously marked.





4 Choose whether or not to print shooting date and photo information.

Tap **Date** to place in the checkbox to imprint the shooting date on the picture.

Tap **Info** to place in the checkbox to imprint the photo information (shutter speed and aperture) on the picture.

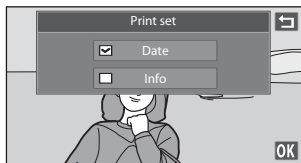
Tap **OK** to complete the print order.



Pictures selected for printing are recognized by the  icon displayed with playback.

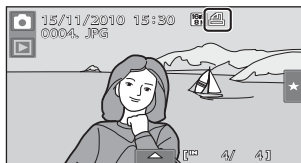

Creating a Print Order for Multiple Pictures

- 1 Switch to thumbnail playback mode (📖 79), tap the bottom tab to display the setting controls, and then tap 📄.

The monitor display switches to the print set screen.



- 2 Tap the desired pictures to print (up to 99) and tap 📄 or 📄 at the upper left in the monitor to specify the number of copies (up to nine) for each.

Pictures selected for printing can be recognized by the check mark (✔) and the numeral indicating the number of copies to be printed. Revert the number of copies to [0] to cancel the selection of the picture.

Tap 🔍 or 🔍 to change the number of pictures displayed.

Tap 🔄 to remove print marking from all pictures and cancel the print order.

Tap OK when setting is complete.

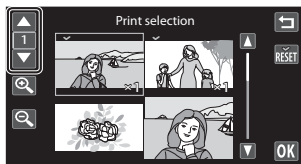

- 3 Choose whether or not to print shooting date and photo information.

Tap **Date** to place ✔ in the checkbox to imprint the shooting date on all pictures in the print order.

Tap **Info** to place ✔ in the checkbox to imprint the photo information (shutter speed and aperture) on all pictures in the print order.

Tap OK to complete the print order.

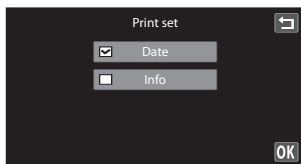

Canceling Print Order

- To remove a print marking from a picture, display a picture selected for printing in full-frame playback mode, follow the procedure in “Creating a Print Order for One Picture” (📖 102), and tap 0 in step 3.
- To remove print markings from multiple pictures at a time, remove the print markings of the desired pictures in step 2 of “Creating a Print Order for Multiple Pictures” (📖 104). Tap  to remove print markings from all pictures.

Notes on Printing with Shooting Date and Photo Information

When the **Date** and **Info** settings are enabled in the print set option, shooting date and photo information are printed on pictures when a DPOF-compatible printer (📖 187) which supports printing of shooting date and photo information is used.

- Photo information cannot be printed when the camera is connected directly to a printer, via the supplied USB cable, for DPOF printing (📖 144).
- Note that **Date** and **Info** settings are reset when the print set option is displayed.
- The printed date is the one that has been set when a picture is taken. Although the date is changed using the **Date** option in the setup menu after a picture has been taken, the printed date will not be reflected.



Note on Printing Pictures



When printing pictures taken at an **Image mode** setting of  **3968x2232** (default setting), the edges of pictures may be cropped, preventing printing of complete pictures (📖 138).

Date Imprint

When date and time of recording are imprinted on pictures using the **Date imprint** option (📖 152) in the setup menu, pictures are recorded with shooting date and time imprinted on the picture when they are taken. Pictures with the date imprinted on them can be printed from printers that do not support printing of the date on pictures. Only the **Date imprint** date and time on pictures will be printed, even if **Print set** is enabled with **Date** selected in the print set screen.

Rotate Image

Specify the orientation in which recorded pictures are displayed with playback. Still pictures can be rotated 90 degrees clockwise or 90 degrees counterclockwise. Pictures that were recorded in portrait (“tall”) orientation can be rotated up to 180 degrees in either direction.

- 1 Select a picture in the full-frame playback mode ( 78), tap the bottom tab to display the setting controls, and tap .

The retouch menu is displayed.

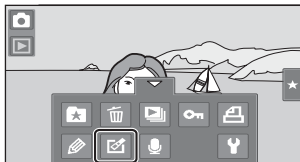

- 2 Tap .

The rotate image screen is displayed.

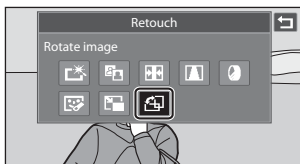

- 3 Tap  or .

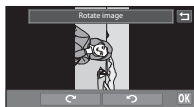

Rotate 90 degrees clockwise



Rotate 90 degrees counterclockwise

The picture rotates 90 degrees.

Tap **OK** to finalize display orientation and save the orientation information with the picture.

To exit without rotating image, tap .

Voice Memo: Recording and Playback

Use the camera's built-in microphone to record voice memos for pictures.

Recording Voice Memos

- 1 Select a picture in the full-frame playback mode ( 78), and tap the bottom tab.

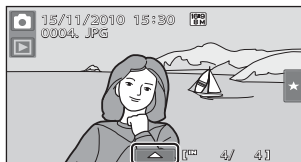

- 2 Tap .

The screen for recording voice memos is displayed.



- 3 Tap  to record a voice memo.

Recording ends after 20 seconds.

Do not touch the built-in microphone during recording.

To exit without recording voice memos, tap .

During recording, **REC** blinks in the monitor.

When  is tapped during recording, recording ends.

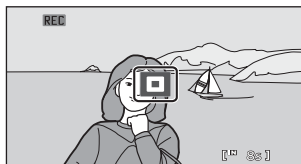

When recording ends, the voice memo playback screen is displayed. Follow the instructions in step 3 of "Playing Voice Memos" ( 108) to play the voice memo.



More Information

See "Image/Sound File and Folder Names" ( 171) for more information.

Playing Voice Memos

Pictures for which voice memos have been recorded are indicated with the  icon in full-frame playback mode ( 10).

- 1 Select a picture in the full-frame playback mode (, 78), and tap the bottom tab.

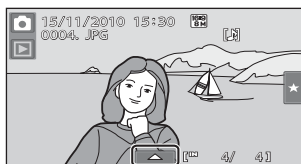

- 2 Tap .

The screen for playing back voice memos is displayed.

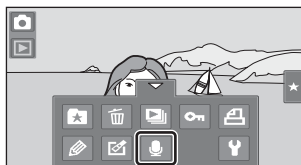

- 3 Tap  to play the voice memo.

Tap  to stop playback.

Tap  to adjust playback volume.

To exit without playing voice memos, tap .



Deleting Voice Memos

Tap  in step 3 of “Playing Voice Memos.”

Tap **Yes** to delete only the voice memo.



Notes on Voice Memos

- When a picture with a voice memo attached is deleted, both the picture and its voice memo are deleted.
- If a voice memo already exists for the current picture, it must be deleted before a new voice memo can be recorded.
- The COOLPIX S80 is not able to record a voice memo for pictures taken with another make or model of digital camera.

Editing Functions

Use the COOLPIX S80 to edit pictures in-camera and store them as separate files (📖 171). The editing functions described below are available.

Editing function	Description
Paint (📖 111)	Draw on pictures, or add decorations, to pictures.
Quick retouch (📖 114)	Easily create retouched copies in which contrast and saturation have been enhanced.
D-Lighting (📖 115)	Create a copy of the current picture with enhanced brightness and contrast, brightening dark portions of the picture.
Stretch (📖 116)	Stretch the current picture horizontally to make the subject appear thinner or wider.
Perspective control (📖 117)	Adjust the perspective of picture taken in landscape orientation. Apply perspective control similar to that available with shift lenses. This function is suited to pictures of buildings or architecture.
Filter effects (📖 118)	Apply a variety of effects using digital filter. The available effects are Color options , Soft , Selective color , Cross screen , Fisheye , and Miniature effect .
Glamour retouch (📖 120)	Make facial skin tone softer and make faces look smaller with larger eyes.
Small picture (📖 122)	Create a small copy of pictures suitable for use as e-mail attachments.
Crop (📖 123)	Crop a portion of the picture. Use to zoom in on a subject or arrange a composition.

See page 106 for the rotate image function for more information.

✔ Notes on Picture Editing

- The editing functions of COOLPIX S80 cannot be used for pictures taken with another make or model of digital camera.
- If no face is detected in a picture, a copy cannot be created using the glamour retouch function (📖 120).
- Edited copies created with COOLPIX S80 may not be displayed properly on another make or model of digital camera. It may also be impossible to transfer them to a computer using another make or model of digital camera.
- Editing functions are not available when there is not enough free space in the internal memory or on the memory card to store the edited copies.

Restrictions on Picture Editing

When an edited copy is further modified with another editing function, check the following restrictions.

Editing function used	Editing function to add
Paint	The paint, small picture, and crop functions can be added.
Quick retouch D-Lighting Stretch Perspective control Filter effects	The paint, small picture, glamour retouch, or crop function can be added.
Glamour retouch	The editing functions other than glamour retouch can be added.
Small picture	Another editing function cannot be added.
Crop	No other editing functions can be added, except for the paint function, which can be applied to cropped copies with an aspect ratio of 16:9 and those saved at an image size of 640 × 480 pixels or larger.

- Copies created with editing functions other than the paint function cannot be further edited with the same function used to create them.
- When combining the small picture or crop function and another editing function, use the small picture and crop functions after other editing functions have been applied.
- Retouch effects such as the glamour retouch function's skin softening effect can be applied to pictures taken with the skin softening function (📖 74).



Original and Edited Pictures

- Copies created with editing functions are not deleted if the original pictures are deleted. The original pictures are not deleted if copies created with editing functions are deleted.
- Edited copies are stored with the same recording date and time as the original.
- The rating settings (📖 97), protect settings (📖 100), and print markings (📖 102) of the original image are not applied to edited copies.

Picture Editing

Paint





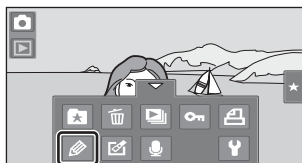

Draw on pictures or decorate them. Shooting date decoration can also be added. Painted copies are stored as separate files.

- 1 Select a picture in full-frame playback mode ( 78), tap the bottom tab to display the setting controls, and tap .



- 2 Use the , , , and  tools to paint pictures.

For more information about using each tool, see "Using the Paint Tools" ( 112).

Tap  to display the picture in full-frame playback mode and tap  again to enlarge the picture display by 3x. Tap , , , or  to change the portion of the picture in the monitor. To return to the original display size, tap .

Tap  to undo the last operation applied using the pen, eraser, or decoration tool (up to the last five operations can be undone).

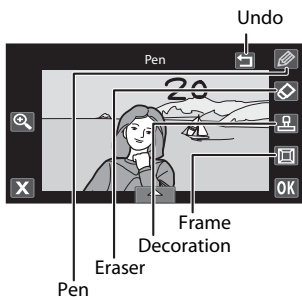

- 3 Tap .

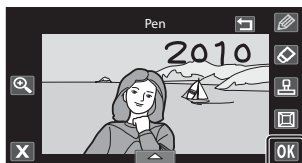

4 Tap Yes.

A new, painted copy is created.

Copies created with pictures taken at an **Image mode** (📖 38) setting of **HS 8M** **3968×2232** are saved at the image size of **2M** (1920 × 1080). Copies created with pictures taken at an image mode setting of **3M**

2048×1536 or larger are saved at the image size of **3M** (2048 × 1536). Copies created with pictures taken at an image mode setting of **PC 1024×768** and **VB 640×480** are saved at the image size of **VB** (640 × 480).

To exit without saving the copy, tap **No**.

Copies created with the paint function can be recognized by the  icon displayed in playback mode.

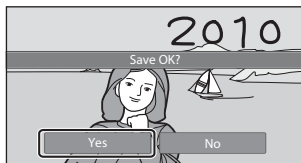

Using the Paint Tools

Write and Draw on Pictures

Tap  to write or draw on pictures.

To change the pens' color or weight, tap the bottom tab to display the screen shown at right.

- Tap or drag the pen's color slider to select pen's color.
- Tap the pen's thickness slider to select pen's thickness.

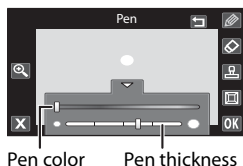

Erase Paint Tool Additions

Tap  to erase additions to pictures using the paint or decoration tool.

To change the eraser's size, tap the bottom tab to display the screen shown at right.

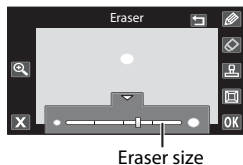

- Tap the slider of the eraser's size to select the size of the eraser.



Add Decorations

Tap  to add a decoration.

To change the decoration type or size, tap the bottom tab to display the screen shown at right.

- Decoration type can be selected from 14 types.
- Tap the decoration size slider to select the decoration size. When  is selected for the decoration type,  (day, month, year) and  (day, month, year, time) options are available.

Decoration type

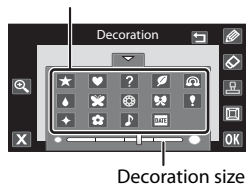



Add a Frame

Tap  to add a frame around the picture.

- Tap  or  to display seven different frames one at a time. Tap  to select a frame.



Notes on Shooting Date Decoration



- When the shooting date decoration is added to pictures taken at an **Image mode** setting ( 38) of **VB** 640×480, the shooting date may be difficult to read. Set the **Image mode** setting of **PC** 1024×768 or larger.
- The date added with the shooting date decoration uses the format selected in the setup menu's **Date** item ( 20, 148).
- The date added with the shooting date decoration is the date on which the picture was taken. The date added with the shooting date decoration cannot be changed.

More Information

See "Image/Sound File and Folder Names" ( 171) for more information.

Quick Retouch: Enhancing Contrast and Saturation

Quick retouch can be used to easily create retouched copies in which contrast and saturation have been enhanced. Copies created with the quick retouch function are stored as separate files.

- 1 Select a picture in full-frame playback mode ( 78), tap the bottom tab to display the setting controls, and tap .

The retouch menu is displayed.

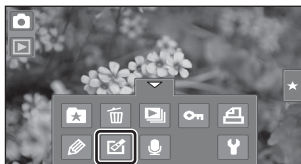

- 2 Tap .

The screen for selecting the degree of enhancement is displayed.

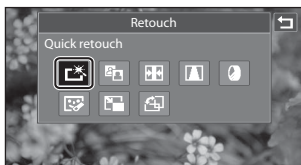

- 3 Choose the degree of enhancement performed and tap .



- 4 Tap **Yes**.

A new, retouched copy is created (it may take several seconds to create the copy).

To exit without saving the copy, tap **No**.

Copies created with the quick retouch function can be recognized by the  icon displayed in playback mode.

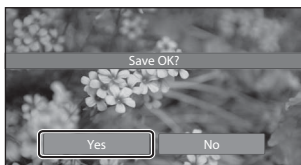



More Information

See "Image/Sound File and Folder Names" ( 171) for more information.

D-Lighting: Enhancing Brightness and Contrast

D-Lighting can be used to create copies with enhanced brightness and contrast, brightening dark portions of a picture. Enhanced copies are stored as separate files.

- 1 Select a picture in full-frame playback mode ( 78), tap the bottom tab to display the setting controls, and tap .

The retouch menu is displayed.



- 2 Tap .

The original version will be shown on the left and the edited version will be shown on the right.

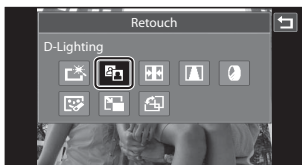

- 3 Tap .



- 4 Tap **Yes**.

A new, edited copy is created.

To exit without saving the copy, tap **No**.

Copies created with the D-Lighting function can be recognized by the  icon displayed in playback mode.





More Information

See "Image/Sound File and Folder Names" ( 171) for more information.

Stretch: Stretching Pictures

Stretch pictures horizontally. Stretched copies are stored as separate files.

- 1 Select a picture in full-frame playback mode ( 78), tap the bottom tab to display the setting controls, and tap .

The retouch menu is displayed.

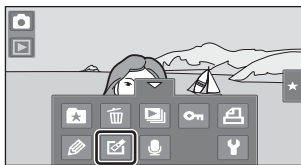

- 2 Tap .

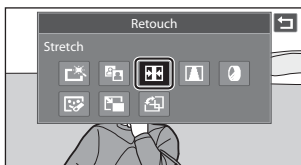

- 3 Tap or drag the slider to adjust stretch effects.

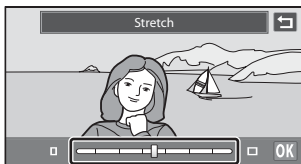

- 4 Tap .

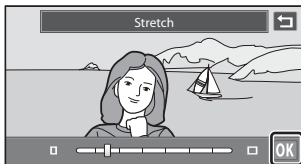

- 5 Tap **Yes**.

A new, edited copy is created.

To exit without saving the copy, tap **No**.

Copies created with the stretch function can be recognized by the  icon displayed in playback mode.

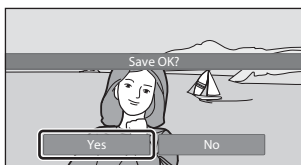



More Information

See "Image/Sound File and Folder Names" ( 171) for more information.

Perspective Control: Adjust a Sense of Perspective

Adjust the sense of perspective in the picture taken in landscape orientation. Copies created with the perspective control function are stored as separate files.

- 1 Select a picture in full-frame playback mode ( 78), tap the bottom tab to display the setting controls, and tap .

The retouch menu is displayed.

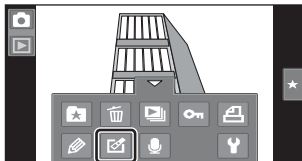

- 2 Tap .

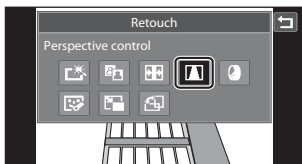

- 3 Tap or drag the slider to adjust perspective control.

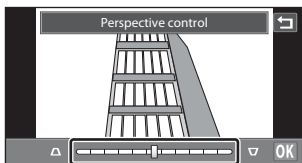

- 4 Tap .

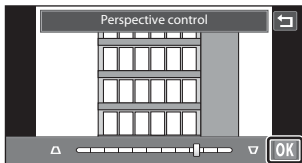

- 5 Tap **Yes**.

A new, edited copy is created.

To exit without saving the copy, tap **No**.

Copies created with the perspective control function can be recognized by the  icon displayed in playback mode.

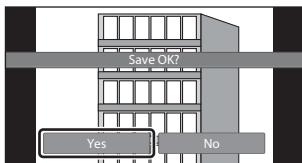

More Information

See "Image/Sound File and Folder Names" ( 171) for more information.

Filter Effects (digital filter)

Filter effects (digital filter) can be used to apply a variety of effects to pictures. The available effects are **Color options**, **Soft**, **Selective color**, **Cross screen**, **Fisheye**, and **Miniature effect**. New copies are stored as separate files.

- 1 Select a picture in full-frame playback mode (📖 78), tap the bottom tab to display the setting controls, and tap .

The retouch menu is displayed.

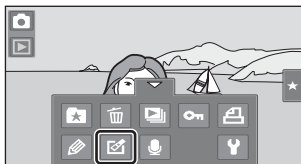



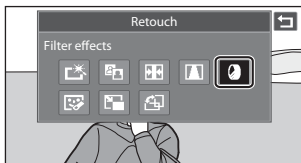

- 2 Tap .

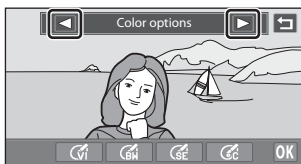

- 3 Tap  or  to select the type of the effects.



Type	Description
Color options	<p>Modify color tones.</p> <ul style="list-style-type: none"> • Select the option from  (vivid color),  (black-and white),  (sepia), or  (cyanotype), and tap .

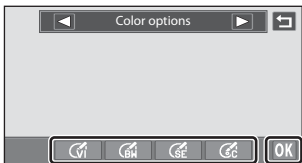

Type	Description
Soft	<p>Give the picture a soft look by blurring the area surrounding the point that is tapped.</p> <ul style="list-style-type: none"> Tap the monitor, select the degree of effects, and tap OK. 
Selective color	<p>Keep one specified color in the picture, and change the other colors to black and white.</p> <ul style="list-style-type: none"> Tap the color slider displayed on the screen to select the color to keep, and tap OK.
Cross screen	<p>Produce star-like rays of light that radiate outward from bright objects such as sunlight reflections or city lights. This effect is suitable for night scenes.</p> <ul style="list-style-type: none"> Confirm the degree of enhancement, and tap OK.
Fisheye	<p>Make a picture look as if it were taken with a fisheye lens. This effect is well-suited for pictures taken in macro mode.</p> <ul style="list-style-type: none"> Confirm the degree of enhancement, and tap OK.
Miniature effect	<p>Make a picture look like a miniature scene taken in macro mode. This effect is well-suited for pictures taken from a high vantage point with the main subject at the center of the picture.</p> <ul style="list-style-type: none"> Confirm the degree of enhancement, and tap OK.

A confirmation screen for saving the edited copy is displayed.

Tap  to return to the retouch menu without making any changes.

4 Tap **Yes** in the confirmation dialog.

A new, edited copy is created.

To exit without saving the copy, tap **No**.

Copies created using the filter effects function can be recognized by the  icon displayed in playback mode.





More Information

See "Image/Sound File and Folder Names" ( 171) for more information.

Glamour Retouch

Glamour retouch can be used to soften the skin tone of faces detected in a picture and make the faces look smaller with larger eyes. New copies are stored as separate files.

- 1 Select a picture in full-frame playback mode ( 78), tap the bottom tab to display the setting controls, and tap .

The retouch menu is displayed.



- 2 Tap .

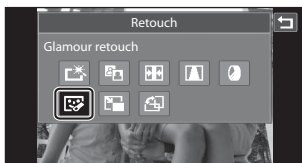

- 3 Tap  (skin softening) or  (both).

: Soften facial skin tones

: Soften facial skin tones, make faces look smaller, and make eyes look larger.



The preview screen is displayed.



- 4 Preview the result of the effects.

Skin tones in up to 12 faces, in the order of that closest to the center of the frame, are softened.

Tap **Before** or **After** to view the picture with or without the effects.

If more than one face was softened, tap  or  to display a different face.

To change the effects, tap  to return to step 3.

Tap **OK** to display the confirmation dialog for saving the new copy.

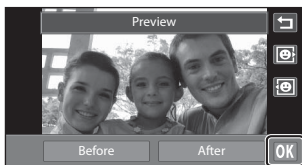

5 Tap **Yes**.

A new, edited copy is created.

To exit without saving the copy, tap **No**.

Copies created using the glamour retouch function can be recognized by the  icon displayed in playback mode.



Notes on Glamour Retouch





- The glamour retouch function cannot be performed when no face is detected in the picture.
- The glamour retouch function may not perform as expected depending on the direction in which the faces are looking or the brightness of the faces in the picture.



More Information

See "Image/Sound File and Folder Names" ( 171) for more information.

Small Picture: Making Smaller Pictures

Create a small copy of the current picture. This feature is useful for creating copies for display on Web pages or e-mail attachments.

- The size of the small copy for pictures taken at an image mode setting of **16:9 8M** **3968x2232** is  (1920 x 1080). For pictures taken at other sizes, the options of  **640x480**,  **320x240**, and  **160x120** are available.
- Small copies are saved as separate files with a compression ratio of 1:16.

- 1 Select a picture in full-frame playback mode ( 78), tap the bottom tab to display the setting controls, and tap .

The retouch menu is displayed.

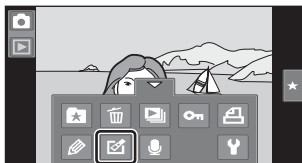

- 2 Tap .

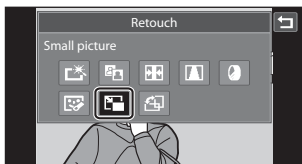

- 3 Tap the desired small copy size icon and tap **OK**.

Small picture size cannot be selected for pictures taken at an image mode setting of **16:9 8M 3968x2232**. Tap **OK**.

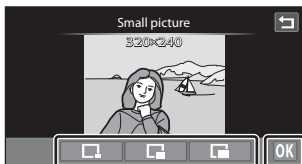

- 4 Tap **Yes**.

A new, small copy is created.

To exit without saving the copy, tap **No**.

The copy is displayed with a gray frame.







More Information

See "Image/Sound File and Folder Names" ( 171) for more information.



✂ Crop: Creating a Cropped Copy

Create a copy containing only the portion visible in the monitor when  is displayed with playback zoom ( 81) enabled. Cropped copies are stored as separate files.

1 Enlarge the desired picture in full-frame playback mode (78, 81).





Portrait-oriented (“tall”) pictures taken at an image mode setting of  **3968×2232** must be rotated into landscape orientation and enlarged before they can be cropped ( 106). If portrait-oriented (“tall”) pictures taken at an image mode setting other than  **3968×2232** are enlarged and cropped in portrait orientation, the cropped images will be in landscape orientation. To create a portrait-oriented (“tall”) cropped copy, rotate the picture into landscape orientation ( 106), before enlarging and cropping.

2 Refine copy composition.

Tap  or  to adjust the zoom ratio.
Drag the picture so that only the portion to be cropped is visible in the monitor.



3 Tap .

When  is not displayed, adjust the zoom ratio so that  is displayed.
Pictures taken at an image mode setting of  **3968×2232** can be cropped when the zoom ratio is 2.0x or less.
Portrait-oriented (“tall”) pictures taken at image mode settings other than  **3968×2232** cannot be cropped if the zoom ratio is too low.



4 Tap Yes.





A cropped copy is created.
To exit without saving the copy, tap **No**.
Copies created using the crop function can be recognized by the  icon displayed in playback mode.



Image Size

- When pictures taken at an image mode setting of  **3968×2232** are cropped, the size of the cropped copies is  (1920 × 1080 pixels) and the aspect ratio is 16:9.
- When pictures taken at image mode settings other than  **3968×2232** are cropped, the aspect ratio of the cropped copies is 4:3. As the area to be saved is reduced, the image size (pixels) of the cropped copy is also reduced.
- When the size of the cropped copy is 320 × 240 or 160 × 120, a gray frame is displayed around the picture, and the small picture icon  is displayed on the top of the screen in full-frame playback mode.

More Information

See “Image/Sound File and Folder Names” ( 171) for more information.

Recording Movies

Record high-definition movies with sound recorded via the built-in microphone.

- The maximum recording time for a single movie is 29 minutes, even when there is sufficient free space on the memory card for longer recording (📖 127).

- 1 Tap the shooting mode icon in shooting mode to display the shooting mode selection menu and then tap 🎥.

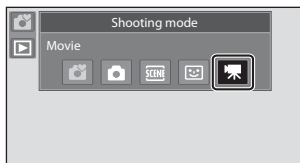

- 2 Press the shutter-release button all the way down to start recording.

The camera focuses on the subject at center of the frame.

A progress bar shows the amount of recording time remaining.

To end recording, press the shutter-release button all the way down again.

Movie recording can also be initiated or stopped by tapping the monitor.

Recording stops automatically when the maximum movie length that can be recorded has run out.



✔ Recording Movies

- Memory cards with an SD Speed Class rating of 6 or faster are recommended when recording movies (📖 170). Movie recording may stop unexpectedly when memory cards with a lower Speed Class ratings are used.
- The camera focuses when the shutter-release button is pressed halfway, and the focus remains locked while the shutter-release button is pressed halfway. Focus is locked while recording.
- Digital zoom deteriorates picture quality. When recording movies, the digital zoom can magnify the image up to 2X the maximum optical zoom ratio.
- In some cases, movie recordings may capture the sounds of the camera, such as the sound of the lens movement when zooming, the vibration reduction function, or the aperture control when the brightness changes.
- Smear (📖 168) visible in the monitor with movie recording will be recorded with movies. Avoiding bright objects such as the sun, reflections of the sun, and electric lights when recording movies is recommended.
- When recording or playing back movies, colored stripes (interference patterns or moiré) may appear on subjects that have a regular, repeating grid, such as pattern of weave in cloths or windows in a building, depending on the shooting distance or zoom ratio. This phenomenon occurs when the subject's pattern interferes with the camera sensor grid, and it does not indicate a malfunction.

✔ Note on Saving Movies

After a movie has been recorded, it is not fully saved to the internal memory or memory card until monitor display returns to the shooting display. **Do not open the battery-chamber/memory card slot cover** before movies have been fully saved. Removing the memory card while movies are being saved could result in loss of data or in damage to the camera or card.

Movie Recording Settings

During movie recording, the settings indicated below can be made by tapping the tabs to display the settings controls.

- Each icon also indicates the current setting.
- Tap the icon of the desired item to display the setting screen for that item.
- To hide the setting controls, tap the tab again.

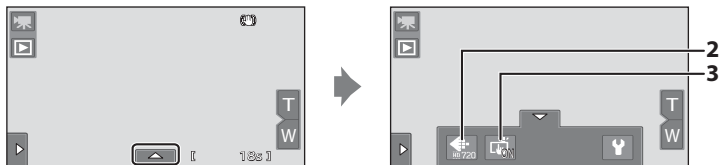
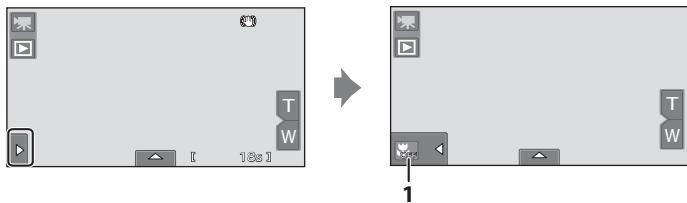

1 Macro mode

Enable the macro mode ( 54) for shooting.

2 Movie options

Select the movie type ( 127).



3 Touch shooting

Select **ON** (default) or **OFF** to activate or deactivate the touch shutter ( 41).

⏪ Movie Options



📷 Shooting mode → Tap the bottom tab (📖 12) → ⏪ Movie options

Select the desired movie option to record. Larger image sizes and faster movie bitrates mean greater image quality and larger movie file sizes.

Option	Description
 HD 720p (1280×720) (default setting)	Movies with an aspect ratio of 16:9 are recorded in high definition. This option is suited to playback on a wide screen TV. <ul style="list-style-type: none"> • Image size: 1280 × 720 pixels • Movie bitrate: 9 Mbps
 VGA (640×480)	Movies with an aspect ratio of 4:3 are recorded. <ul style="list-style-type: none"> • Image size: 640 × 480 pixels • Movie bitrate: 3 Mbps
 QVGA (320×240)	Movies with an aspect ratio of 4:3 are recorded. <ul style="list-style-type: none"> • Image size: 320 × 240 pixels • Movie bitrate: 640 kbps

- The movie bitrate is the volume of movie data recorded per second. As a variable bitrate (VBR) system has been adopted, the movie recording rate varies automatically according to the subject so that more data is recorded per second for movies containing frequently moving subjects, thus increasing movie file size.
- The frame rate is approximately 30 frames per second in any options.

📄 Movie Options and Maximum Movie Length

Option	Internal memory (approx. 79 MB)	Memory card (4 GB)*
 HD 720p (1280×720)	1 min 4 s	55 min
 VGA (640×480)	3 min	2 h 40 min
 QVGA (320×240)	8 min 26 s	10 h 10 min

All figures are approximate. The maximum recording time may vary by make of memory card and the bitrates at which the movie was recorded.

* The maximum recording time for a single movie is 29 minutes. The maximum movie length displayed during recording is 29 minutes, even when there is enough free space on the memory card for a longer movie.

💡 More Information

See "Image/Sound File and Folder Names" (📖 171) for more information.

Movie Playback

In full-frame playback mode (📖 78), movies are recognized by 🎬 icon. Tap 🎬 to play a movie.

- To adjust the volume before playback, tap the bottom tab to display the setting controls and tap 🔊.



Tap the monitor during playback to display the control panel at the bottom of the monitor. The operations described below are available by tapping the icons in the panel.

During playback

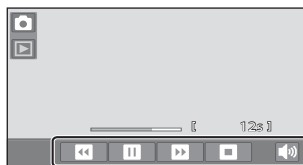

To	Tap	Description
Adjust volume	🔊	Tap 🔊 to adjust the volume.
Rewind	⏮	Touch and hold ⏮ to rewind movie.
Advance	⏭	Touch and hold ⏭ to advance movie.
Pause	⏸	Pause playback. The following operations can be performed while playback is paused.
		⏮ Rewind movie back one frame. Touch and hold ⏮ for continuous frame-by-frame rewind.
		⏭ Advance movie forward one frame. Touch and hold ⏭ for continuous frame-by-frame advance.
	🎬	Tap 🎬 at the center of the monitor to resume playback.
End	⏹	End playback and return to full-frame display.

✔ Note on Movie Playback

Movies recorded by a camera other than the COOLPIX S80 cannot be played back.

✎ Deleting Movie Files

See "Deleting Unwanted Pictures" for more information (📖 31).

Connecting to a TV

Connect the camera to a television to play back pictures or movies on the television. If your TV is equipped with an HDMI port, pictures can be displayed in high definition when an HDMI cable (commercially available) is used to connect the camera to the TV.

- 1 Close the slide cover to turn off the camera.

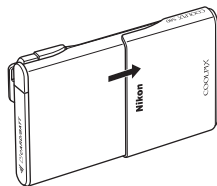

- 2 Connect the camera to the TV.

When using the supplied audio/video cable

Connect the yellow plug to the video-in jack and the white and red plugs to the stereo audio-in jacks on the TV.

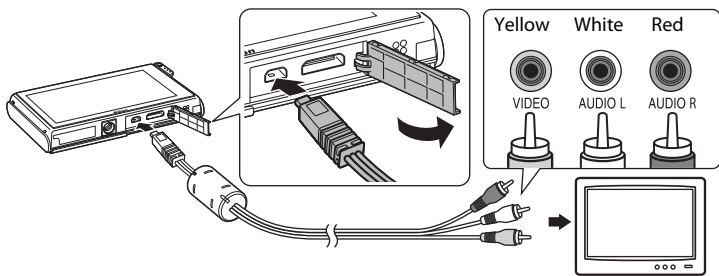

When using a commercially available HDMI cable

Connect the plug to the HDMI jack on the TV.

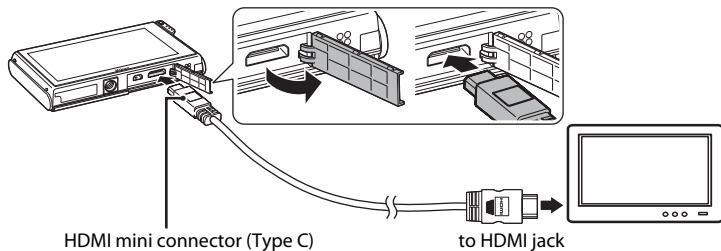

3 Tune the television to the video channel.

See the documentation provided with your television for details.

4 Open the slide cover to turn on the camera.

Pictures are displayed on the television and the camera monitor turns off.

See "Operations with TV Connection" (📖 131) for more information.

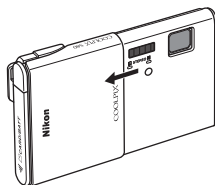

Operations with TV Connection

While pictures are displayed full-frame on the TV, the previous or subsequent picture can be viewed by dragging your finger across the camera monitor.

Drag the picture with two fingers to scroll ahead or back ten pictures at a time. Thumbnail playback (📖 79) and playback zoom (📖 81) are possible just as with playback mode on the camera.

When the first frame of a movie is displayed, the movie can be played back by holding your finger on the camera monitor and removing it after about one second.

- Tap the camera monitor to turn TV display off and display the picture in the camera monitor. When pictures are displayed in the camera monitor, tap the controls displayed to operate the camera (only during playback mode).
- Pictures will be automatically displayed on the TV in the following situations.
 - No operations are performed for a few seconds in playback mode.
 - A slide show is played back.
 - A movie is played back.

✔ Notes on Connecting the HDMI Cable

- HDMI cable is not provided. Use a commercially available HDMI cable to connect the camera to a high-definition TV. The output terminal on this camera is an HDMI mini connector (type C). When purchasing an HDMI cable, be sure that the device end of the cable is an HDMI mini connector.
- **Image mode** (📖 38) settings of **8M 2048 × 1536** or higher and a **Movie options** (📖 127) setting of **7M HD 720p (1280 × 720)** are recommended for pictures or movies that will be played back on a TV via HDMI connection.

✔ Connecting the Cable

When connecting the cable, be sure that the camera connector is properly oriented. Do not use force when connecting the cable. When disconnecting the cable, do not pull the connector at an angle.

- Do not connect the HDMI cable and audio/video cable to the camera simultaneously.
- Do not connect the HDMI cable and USB cable to the camera simultaneously.

✔ Video Mode

Be sure that the camera's video mode setting conforms to the standard used by your television. The video mode setting is specified from the **TV settings** (📖 158) option in the setup menu (📖 145).

Connecting to a Computer

Use the supplied USB cable to connect the camera to a computer and copy (transfer) images to the computer.

Before Connecting the Camera

Install the Software

Use the supplied ViewNX 2 CD and install the following software on the computer.

- ViewNX 2: Use the image transfer feature “Nikon Transfer 2” to save images that were captured with the camera on the computer. Saved images can be viewed and printed. Image and movie editing features are also supported.
- Panorama Maker 5: This software can join a series of images to create a single panorama image.

For more information on installing the software, refer to the *Quick Start Guide*.

Compatible Operating Systems

Windows

Windows 7 Home Basic/Home Premium/Professional/Enterprise/Ultimate, Windows Vista Home Basic/Home Premium/Business/Enterprise/Ultimate (Service Pack 2), or Windows XP Home Edition/Professional (Service Pack 3)

Macintosh

Mac OS X (version 10.4.11, 10.5.8, 10.6.4)

For information on the requirements for playing back high-definition movies, refer to “System Requirements” in the ViewNX 2 help information (📖 136).

Refer to the Nikon website for the latest information on operating system compatibility.

Note on Computer Connection

Disconnect other USB devices such as commercial USB chargers from the computer. Simultaneous connection of the camera and other USB devices to the computer could result in operation malfunction or excessive supply of power to the camera, causing damage to the camera or memory card. Refer to the documentation supplied with other USB devices for more information.

✓ Notes on Power Source

- When connecting the camera to a computer to transfer images, use a fully charged battery to prevent the camera from turning off unexpectedly.
- When the camera is connected to a computer via the supplied USB cable with **Auto** (default setting) selected for the **Charge by computer** option in the setup menu, the battery inserted into the camera is automatically charged using power supplied by the computer (📖 137, 159).
- If the AC Adapter EH-62D (📖 169) (available separately) is used, COOLPIX S80 can be powered from an electrical outlet. Do not use any other make or model of AC adapter as they may cause the camera to overheat or malfunction.

Transferring Images from a Camera to a Computer

- 1 Start the computer to which ViewNX 2 was installed.
- 2 Be sure that the camera is off.
- 3 Connect the camera to the computer using the supplied USB cable.

Be sure that connectors are properly oriented. Do not attempt to insert connectors at an angle, and do not use force when connecting or disconnecting the USB cable.

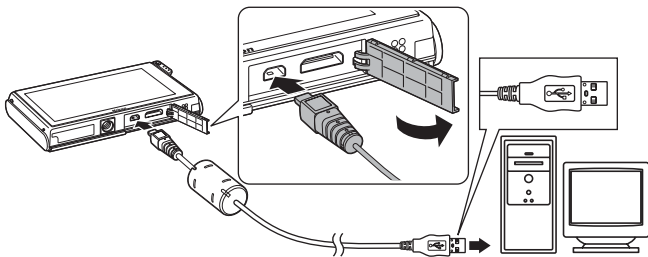

The camera is automatically turned on and the power-on lamp will light or blink. The camera monitor will remain off.



✓ Connecting the USB Cable

The connection may not be recognized if the camera is connected to the computer via a USB hub.

4 Start the ViewNX 2 image transfer feature “Nikon Transfer 2” installed on the computer.

• Windows 7

When the **Devices and Printers ▶ S80** screen is displayed, click **Change program** under **Import pictures and videos**. Select **Import File using Nikon Transfer 2** in the **Change program** dialog and click **OK**.

Double-click **Import File** on the **Devices and Printers ▶ S80** screen.

• Windows Vista

When the **AutoPlay** dialog is displayed, click **Import File using Nikon Transfer 2**.

• Windows XP

When the action selection dialog is displayed, select **Nikon Transfer 2 Import File**, and click **OK**.

• Mac OS X

Nikon Transfer 2 will start automatically when the camera is connected to the computer if **Yes** was selected in the **Auto-Launch setting** dialog when Nikon Transfer 2 was first installed.

- If charge for the battery inserted into the camera is low, the computer may not recognize the camera. If the camera is not recognized, images will not be transferred. When battery charging starts automatically using power supplied by the computer, wait until battery charge has reached a sufficient level to begin transfer.
- If there are a large number of images on the memory card, it may take some time for Nikon Transfer 2 to start.

5 Confirm that the source device is displayed in the transfer options **Source** panel and click **Start Transfer**.

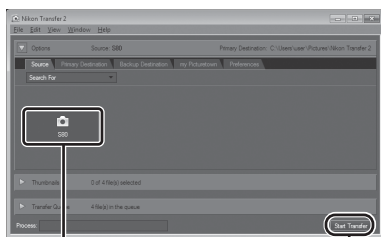

Source device

Start Transfer button

Any images that have not been transferred to the computer will be transferred (default setting of ViewNX 2).

ViewNX 2 starts automatically when the transfer is complete (default setting of ViewNX 2). Transferred images can be viewed.

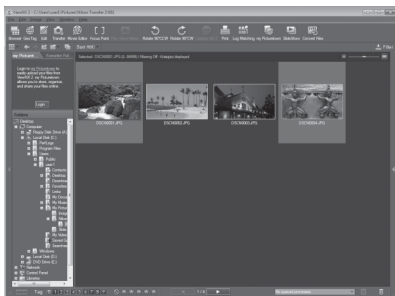

For more information on using ViewNX 2, refer to the ViewNX 2 help information (📖 136).

Disconnecting the Camera

Do not turn off the camera or disconnect the camera from the computer during transfer.

When transfer is complete, open the slide cover and close it again to turn off the camera, and disconnect the USB cable.

The camera turns off automatically if there is no communication with the computer for 30 minutes while the camera is connected via the USB cable.

🔋 Charging the Battery

The power on lamp slowly blinks orange while the battery inserted into the camera is charging (📖 137).

Transferring Images Using a Computer's Card Slot or a Commercially-available Card Reader

When the memory card is inserted into a computer's card slot or into a commercially-available card reader, the images can be transferred using "Nikon Transfer 2", the image transfer feature of ViewNX 2.

- Make sure that the memory card being used is supported by the card reader or other card reading device.
- To transfer images, insert the memory card into the card reader or card slot and follow the procedure from step 4 (📖 134).
- To transfer images saved in the camera's internal memory, the images must first be copied to a memory card using the camera (📖 164).

Starting ViewNX 2 or Nikon Transfer 2 Manually

Windows

Choose **Start** menu > **All Programs** > **ViewNX 2** > **ViewNX 2**.

Double-clicking the **ViewNX 2** shortcut icon on the desktop will also start ViewNX 2.

Mac OS X

Open the **Applications** folder, open the **Nikon Software** > **ViewNX 2** folders in that order, and then double-click the **ViewNX 2** icon. Clicking the **ViewNX 2** icon on the Dock will also start ViewNX 2.

Click **Transfer** in the ViewNX 2 screen to start Nikon Transfer 2.

Viewing ViewNX 2 Help Information

For more information on ViewNX 2 or Nikon Transfer 2, start ViewNX 2 or Nikon Transfer 2 and select **ViewNX 2 Help** from the **Help** menu.

Panorama Creation with Panorama Maker 5

- Use a series of images captured in **Panorama assist** scene mode (📖 70) to create a single panorama photo with Panorama Maker 5.
- Panorama Maker 5 can be installed on a computer using the supplied ViewNX 2 CD.
- After installation is complete, follow the procedure described below to start Panorama Maker 5.

Windows

Choose **Start** menu > **All Programs** > **ArcSoft Panorama Maker 5** > **Panorama Maker 5**.

Mac OS X

Open **Applications** and double-click the **Panorama Maker 5** icon.

- For more information on using Panorama Maker 5, refer to the on-screen instructions and help information contained in Panorama Maker 5.

Image File Names and Folder Names

See "Image/Sound File and Folder Names" (📖 171) for more information.

Charging While Connecting to a Computer

When the **Charge by computer** option (📖 159) in the camera's setup menu is set to **Auto** (default setting), if the camera is connected to a computer using the USB cable, the battery inserted into the camera can be automatically charged depending on the ability of the computer to supply power.

See "Before Connecting the Camera" (📖 132) and "Transferring Images from a Camera to a Computer" (📖 133) for more information on connecting the camera to a computer.

Power-on Lamp

The following chart explains power-on lamp status when the camera is connected to a computer.

Power-on lamp	Description
Blinks slowly (orange)	Battery charging.
Glow (green)	Battery not charging. Charging is complete when the power-on lamp stops blinking orange and glows green.
Flickers (orange)	<ul style="list-style-type: none"> The ambient temperature is not suited to charging. Charge the battery indoors with an ambient temperature of 5 °C to 35 °C (41 °F to 95 °F). A USB cable is not correctly connected or the battery is faulty. Reconnect the USB cable correctly or replace the battery. Computer is in sleep mode and does not supply power. Reboot a computer. The battery cannot be charged as computer's specifications or settings does not support power supply to the camera.

✓ Notes on Charging with Connection to a Computer

- The battery cannot be charged, nor can data be transferred, when the camera is connected to a computer before the camera's display language and date and time have been set (📖 20). If the camera's clock battery (📖 149) has been exhausted, the date and time must be reset before the battery can be charged or images can be transferred with connection to a computer. In this case, use the Charging AC Adapter EH-68P (📖 16) to charge the battery and then set the camera's date and time.
- If the camera is turned off by opening and closing the slide cover, charging will also stop.
- If a computer enters sleep mode while charging, charging will stop and the camera may be turned off.
- When disconnecting the camera from a computer, turn the camera off by opening and closing the slide cover and then disconnect the USB cable.
- About 3 hours are required to charge a fully exhausted battery. Charging time increases when images are transferred while the battery is charging.
- When the camera is connected to a computer, an application installed on the computer, such as Nikon Transfer 2, may start. If the camera was connected to the computer for the sole purpose of charging the battery, exit the application.
- The camera turns off automatically if there is no communication with the computer for 30 minutes after the battery has finished charging.
- Depending upon computer specifications, settings, and power supply and allocation, it may be impossible to charge the battery inserted into the camera via computer connection.

Connecting to a Printer

Users of PictBridge-compatible (📖 187) printers can connect the camera directly to the printer and print pictures without using a computer.

Follow the procedures below to print pictures.

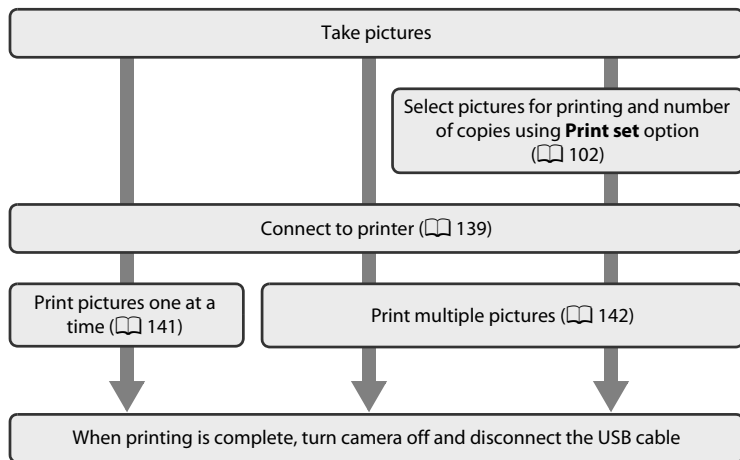

✔ Notes on Power Source

- When connecting the camera to a printer, use a fully charged battery to prevent the camera from turning off unexpectedly.
- If the AC Adapter EH-62D (available separately) is used, COOLPIX S80 can be powered from a home electrical outlet. Do not use any other AC adapters as it will cause the camera to heat up or malfunction.

✔ Note on Printing Pictures

When printing pictures taken at an **Image mode** setting of **3968x2232** (default setting), the edges of pictures may be cropped, preventing printing of complete pictures.

It may be possible to print complete pictures if settings on the printer are applied so that borders are printed around pictures (borderless printing not enabled).

Refer to the documentation supplied with the printer or consult the digital photo lab for further details to make sure that the printer supports printing at an aspect ratio of 16:9.

📖 Printing Pictures

In addition to printing pictures transferred to a computer from your personal printer and printing over a direct camera-to-printer connection, the following options are also available for printing pictures stored on the memory card:

- Insert a memory card into a DPOF-compatible printer's card slot
- Take a memory card to a digital photo lab

To print pictures using either of these methods, use your camera's **Print set** option (📖 102) to select the pictures, and the desired number of prints each, from those recorded to a memory card.

Connecting the Camera to a Printer

- 1 Close the slide cover to turn off the camera.

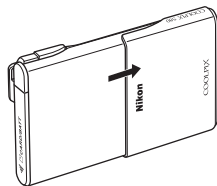

- 2 Turn on the printer.

Check printer settings.

- 3 Connect the camera to the printer using the supplied USB cable.

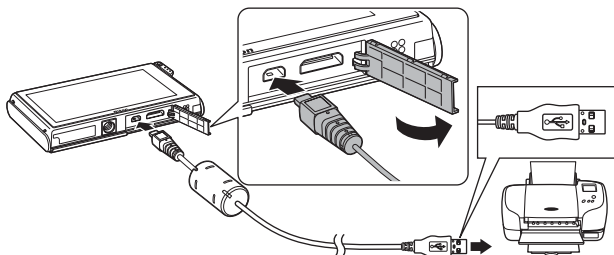

- 4 The camera is automatically turned on.

When properly connected, the **PictBridge** startup screen (①) will be displayed in the camera monitor, followed by the print selection screen (②).

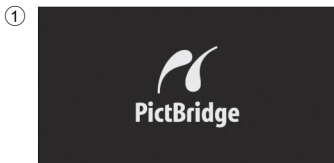

✔ **Notes on Connecting/Disconnecting Cable**

- Be sure that connectors are properly oriented. Do not attempt to insert connectors at an angle, and do not use force when connecting or disconnecting the USB cable.
- Open and close the slide cover to turn off the camera before disconnecting the USB cable.

✔ **If the PictBridge Startup Screen is not Displayed**

Turn the camera off and disconnect the USB cable. Set the **Charge by computer** option (📖 159) in the camera's setup menu to **Off** and reconnect the cable again.

Printing Pictures One at a Time

After properly connecting the camera to the printer (📖 139), follow the procedures described below to print a picture.

- 1 Tap  or  to choose the desired picture, and tap **OK**.

Previous or subsequent picture can also be viewed by tapping the scroll bar.

Tap  to display 12 thumbnails, and  to switch back to full-frame playback.

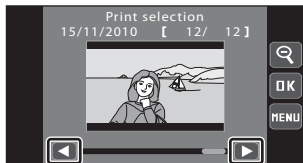

- 2 Tap **Copies**.

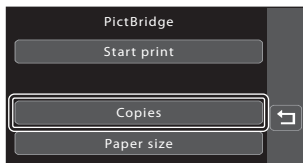



- 3 Tap the desired number of copies (up to nine).



- 4 Tap **Paper size**.



- 5 Tap the desired paper size.

Tap  or  to display additional options.

To specify paper size using settings on the printer, tap **Default** in the paper size option.

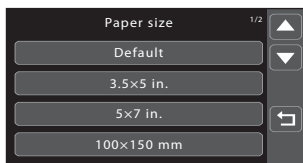

6 Tap **Start print**.**7** Printing begins.

Monitor display returns to the print selection screen shown in step 1 when printing is complete.

To cancel printing before all copies have been printed, tap **Cancel**.

Current number of copies/
total number of copies

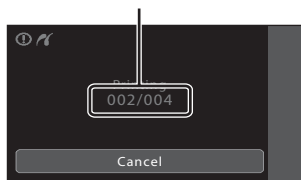
**Printing Multiple Pictures**

After properly connecting the camera to the printer (📖 139), follow the procedures described below to print multiple pictures.

1 When the print selection screen is displayed, tap **MENU**.

The print menu is displayed.

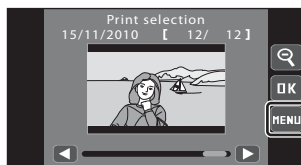
**2** Tap **Paper size**.

To exit the print menu, tap **Back**.



3 Tap the desired paper size.

Tap or to display additional options.

To specify paper size using settings on the printer, tap **Default** in the paper size option.

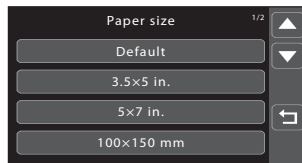
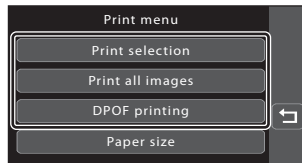
**4** Tap **Print selection**, **Print all images** or **DPOF printing**.**Print selection**

Choose pictures (up to 99) and the number of copies (up to nine) of each.

- Tap the desired pictures and tap or at the upper left in the monitor to specify the number of copies to be printed.
- Pictures selected for printing can be recognized by the check mark () and the numeral indicating the number of copies to be printed. Revert the number of copies to [0] to cancel the selection of the picture.
- Tap to switch back to full-frame playback, and to display 9 thumbnails.
- Tap to remove print marking from all pictures.
- Tap when setting is complete.
- When the screen shown at right is displayed, tap **Start print** to print.
- To return to the print menu, tap **Cancel**.

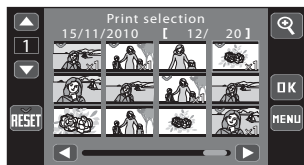

Print all images

One copy each of all pictures stored in the internal memory, or on the memory card, is printed.

- When the screen shown at right is displayed, tap **Start print** to print.
- To return to the print menu, tap **Cancel**.

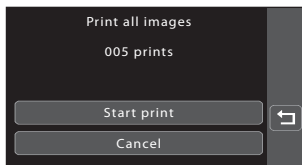

DPOF printing

Print pictures for which a print order was created using the **Print set** option (102).

- When the screen shown at right is displayed, tap **Start print** to print. To return to the print menu, tap .
- To view the current print order, tap **View images**. To print pictures, tap .

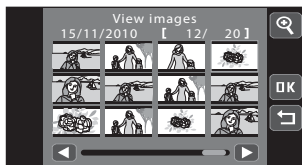

5 Printing begins.

Monitor display returns to the print menu shown in step 2 when printing is complete.

To cancel printing before all copies have been printed, tap **Cancel**.

Current number of copies/
total number of copies

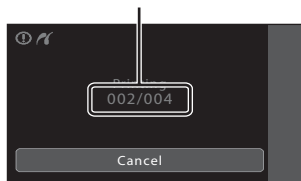







Paper Size

The camera supports the following paper sizes: **Default** (the default paper size for the printer connected to the camera), **3.5 × 5 in.**, **5 × 7 in.**, **100 × 150 mm**, **4 × 6 in.**, **8 × 10 in.**, **Letter**, **A3**, and **A4**. Only sizes supported by the printer will be displayed. To specify paper size using printer settings, choose **Default** in the **Paper size** option.

The Setup Menu

The setup menu contains the following options.

	Welcome screen	 147
	Choose whether or not a welcome screen is displayed when camera is turned on.	
	Date	 148
	Set camera clock and choose home and destination time zones.	
	Monitor settings	 151
	Set the photo information displayed in playback mode, the image review settings, and the monitor brightness.	
	Date imprint	 152
	Imprint shooting date and time on pictures.	
	Vibration reduction	 153
	Choose whether or not vibration reduction is enabled.	
	AF assist	 154
	Enable or disable AF-assist illuminator.	
	Digital zoom	 154
	Enable or disable digital zoom.	
	Sound settings	 155
	Adjust sound and volume when operating the camera.	
	Auto off	 155
	Set time before the monitor turns off for saving power.	
	Format memory/Format card	 156
	Format internal memory or memory card.	
	Language	 157
	Choose the language used for camera monitor display.	
	TV settings	 158
	Adjust settings necessary for connection to television.	
	Charge by computer	 159
	Choose whether or not to charge the camera battery when connecting to a computer via the USB cable.	
	Blink warning	 159
	Specify whether or not the camera detects human faces that have blinked with shooting using face detection.	
	Reset all	 161
	Restore camera settings to default values.	
	Copy	 164
	Copy files between memory card and internal memory.	
	Firmware version	 165
	Display camera firmware version.	

Operating the Setup Menu

- 1 Tap the bottom tab in shooting or playback mode.

See “Opening the Tabs” (12) for more information.



- 2 Tap .

The setup menu is displayed.

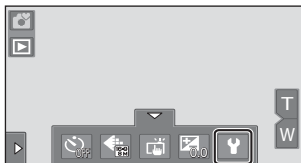

- 3 Tap the desired option.

Tap or to display previous or subsequent page.

Tap to return to the previous screen.

When is displayed in a screen, tap to apply the setting.

To exit the setup menu, tap or press the shutter-release button (when shooting).

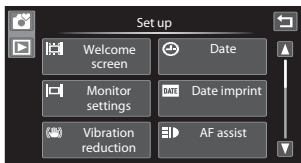

📷 Welcome Screen

Tap the bottom tab (📖 146) → 🙋 (Setup menu) → 📷 Welcome screen

Choose whether or not a welcome screen is displayed when the camera is turned on.

None (default setting)

The camera enters shooting or playback mode without displaying the welcome screen.

COOLPIX

The camera displays a welcome screen and enters shooting or playback mode.



Select an image

Displays a picture selected for the welcome screen. When the **Select image** screen is displayed, select a picture and tap **OK**.

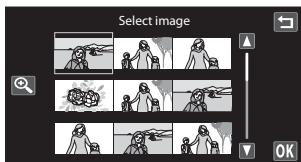
- In the **Select image** screen, tap 🔍 to switch to full-frame playback and tap 🔍 to switch back to 9-thumbnail display.
- As the selected picture is stored in the camera, it will be displayed when the camera is turned on even if the original picture is deleted.
- Copies created at a size of 320 × 240 or smaller using the crop (📖 123) or small picture (📖 122) function cannot be selected.



Date





Tap the bottom tab ( 146) →  (Setup menu) →  Date

Set the camera clock.

Date



Set camera clock to current date and time.

Tap the items on the displayed screen to select the display order of the day, month and year, and set the date and time.

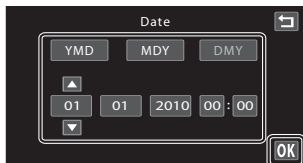
- To select the item: tap the desired item.
- To edit the highlighted item: tap  or .
- To apply the setting: tap  ( 21).



Time zone

Home time zone () can be specified and daylight saving time is enabled or disabled from **Time zone** options. When **Travel Destination** () is selected, local time ( 150) is automatically calculated and shooting date and time in the selected region are recorded with pictures. Useful when travelling.

Selecting Travel Destination Time Zone

1 Tap **Time zone**.

The time zone screen is displayed.

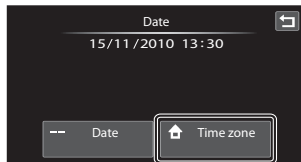



2 Tap **Travel destination**.

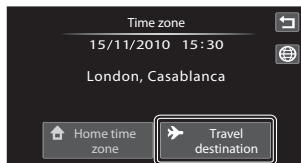

The date and time displayed in the monitor changes according to the region currently selected.

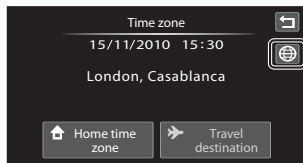

3 Tap .

The time zone selection screen is displayed.

**4** Tap  or  to choose the travel destination time zone and tap **OK**.

If daylight saving time is in effect, tap  to enable daylight saving time function.  is displayed at the top of the monitor and the camera clock is advanced one hour. Tapping  again to disable the daylight saving time function.





While the travel destination time zone is selected, the  icon will be displayed in the monitor when the camera is in shooting mode.

✔ Note on the Clock Battery

The camera clock is powered by the clock battery. The clock battery charges when the main battery is inserted or an AC adapter is connected, and can provide several days of backup power after about ten hours of charging.

 Home Time Zone

- To switch to the home time zone, tap  **Home time zone** in step 2.
- To change the home time zone, tap  **Home time zone** in step 2, and complete steps 3 and 4.

 Daylight Saving Time

When daylight saving time starts or ends, turn the daylight saving time function on or off from the time zone selection screen displayed in step 4.

 Imprinting Date on Pictures

Enable date imprint from the **Date imprint** option ( 152) in the setup menu after the date and time have been set. When the **Date imprint** option is enabled, pictures will be recorded with shooting date imprinted on them.



Time Zones

The camera supports the time zones listed below.

For time zones not listed below, set the camera clock to local time from the **Date** option.

UTC +/-	Location	UTC +/-	Location
-11	Midway, Samoa	+1	Madrid, Paris, Berlin
-10	Hawaii, Tahiti	+2	Athens, Helsinki, Ankara
-9	Alaska, Anchorage	+3	Moscow, Nairobi, Riyadh, Kuwait, Manama
-8	PST (PDT): Los Angeles, Seattle, Vancouver	+4	Abu Dhabi, Dubai
-7	MST (MDT): Denver, Phoenix	+5	Islamabad, Karachi
-6	CST (CDT): Chicago, Houston, Mexico City	+5.5	New Delhi
-5	EST (EDT): New York, Toronto, Lima	+6	Colombo, Dhaka
-4.5	Caracas	+7	Bangkok, Jakarta
-4	Manaus	+8	Beijing, Hong Kong, Singapore
-3	Buenos Aires, Sao Paulo	+9	Tokyo, Seoul
-2	Fernando de Noronha	+10	Sydney, Guam
-1	Azores	+11	New Caledonia
±0	London, Casablanca	+12	Auckland, Fiji

Monitor Settings

Tap the bottom tab (📖 146) → 🗑️ (Setup menu) → 📺 Monitor settings

Set the options below.

Playback

Set the photo information displayed in the monitor during playback. See "Playback (Information Display)" (📖 10) for more information.

- **Show info:**



- **Auto info** (default setting): Current settings and operational guides are displayed as in **Show info** above. If no operations are performed for a few seconds, information is hidden. Information will be displayed again when the next operation is performed.

Image review

On (default setting): Picture is automatically displayed in the monitor immediately after it is taken and the monitor display returns to shooting mode.

Off: Picture is not displayed after it is taken.

Brightness

Choose from five settings for monitor brightness. The default setting is **3**.

📎 Auto Monitor Boost

The camera automatically increases monitor brightness outdoors and under extremely bright lighting to make the monitor display easier to see and read (when **Brightness** is set to **4** or less).

DATE Date Imprint (Imprinting Date and Time)

Tap the bottom tab (📖 146) → 🧑 (Setup menu) → **DATE** Date imprint

The shooting date and time can be imprinted on the pictures with shooting, allowing the information to be printed even from printers that do not support date printing (📖 105).



DATE Date

Date is imprinted on pictures.

DATE Date and time

Date and time are imprinted on pictures.

Off (default setting)

Date and time are not imprinted on pictures.

At settings other than **Off**, the icon for the current setting is displayed in the monitor (📖 8).

✓ Notes on Date Imprint

- Imprinted dates form a permanent part of image data and cannot be deleted. The date and time cannot be imprinted on pictures after they have been taken.
- The date cannot be imprinted in the following situations:
 - Pictures taken in **Sports**, **Museum**, or **Panorama assist** scene mode
 - When **On** is selected for **Blink proof** (📖 75) in smart portrait mode.
 - When **Continuous** or **BSS** is selected for the continuous setting (📖 58).
 - Movies
- Dates imprinted at an **Image mode** setting (📖 38) of **VGA 640 × 480** may be difficult to read. Choose an **Image mode** setting of **PC 1024 × 768** or larger when using date imprint.
- The date is recorded using the format selected in the setup menu's **Date** item (📖 20, 148).

✍ Date Imprint and Print Set

If using a DPOF-compatible printer that supports the printing of shooting date and photo information, it is possible to use the **Print set** option (📖 102) to print such information even on pictures that were not taken using the **Date imprint** option.

Vibration Reduction

Tap the bottom tab ( 146) →  (Setup menu) →  Vibration reduction

Select the vibration reduction option for shooting.

Vibration reduction reduces blur, caused by slight hand movement known as camera shake, which commonly occurs when shooting with telephoto zoom applied or at slow shutter speeds. The effects of camera shake are reduced when recording movies, in addition to when taking still pictures.

Set **Vibration reduction** to **Off** when using a tripod to stabilize the camera during shooting.

On (hybrid)

The effects of camera shake are reduced optically only using a lens-shift method. Additional image processing with electronic vibration reduction is applied to further reduce the effects of camera shake with recording of still pictures taken under the following conditions.

- when flash is disabled.
- when a shutter speed slower than 1/60 seconds is used.
- when **Self-timer** is disabled.
- when **Single** is selected for the **Continuous** setting.
- when ISO sensitivity is set to 200 or less.

On (default setting)

The vibration reduction using the lens-shift method only is enabled.

Off

Vibration reduction is not enabled.

The current vibration reduction setting can be confirmed in the camera monitor with shooting ( 8, 25). When **Off** is selected, no icon is displayed.

Notes on Vibration Reduction

- Vibration reduction may take a few seconds to activate after the power is turned on, or the camera enters shooting mode from playback mode. Wait until the image of the monitor stabilizes before shooting.
- Due to characteristics of the vibration reduction function, images displayed in the camera's monitor immediately after shooting may be displayed blurry.
- Vibration reduction may be unable to completely eliminate the effects of camera shake in some situations.
- Image processing with electronic vibration reduction may not perform as expected with very slight or extreme camera shake, even when **On (hybrid)** is selected.
- Image processing with electronic vibration reduction is not enabled at fast or extremely slow shutter speeds, even when **On (hybrid)** is selected.
- When **On (hybrid)** is selected and electronic vibration reduction is activated, the shutter is automatically released twice when a picture is taken to allow for image processing. Therefore, the time required to record pictures increases. **Shutter sound** ( 155) can be heard only when the shutter is released the first time and a single picture will be recorded.

AF Assist

Tap the bottom tab ( 146) →  (Setup menu) →  AF assist

Enable or disable AF-assist illuminator, which assists autofocus operation when the subject is dimly lit.



Auto (default setting)

AF-assist illuminator will be used to assist the focus operation when the subject is poorly lit. The illuminator has a range of about 4.0 m (13 ft.) at the maximum wide-angle position and about 3.0 m (9 ft. 10 in.) at the maximum telephoto position. Note that for some scene modes or focus areas, AF-assist illuminator may not light.

Off



Disable this function. The camera may be unable to focus under poor lighting.

Digital Zoom

Tap the bottom tab ( 146) →  (Setup menu) →  Digital zoom

Enable or disable digital zoom.

On (default setting)

When the camera is zoomed in to the maximum optical zoom position, tapping  triggers digital zoom ( 27).



Off

Digital zoom will not be activated (except when recording movies).

Notes on Digital Zoom

- The camera focuses on the subject at the center of the frame when digital zoom is in effect.
- Digital zoom cannot be used in the following situations:
 - When **Portrait**, or **Night portrait** scene mode is selected
 - When smart portrait mode is selected
 - **Subject tracking** is selected for the touch shooting setting
 - When **Multi-shot 16** is selected ( 58)

Sound Settings

Tap the bottom tab ( 146) →  (Setup menu) →  Sound settings

Adjust the following sound settings.

Button sound



Turn button sound **On** (default setting) or **Off**. When **On** (default setting) is selected, beep will sound once when operations are completed successfully, twice when the camera acquires focus on the subject, and three times when an error is detected. Start-up sound will also play when the camera is turned on.

Shutter sound

Choose shutter sound from **On** (default setting) or **Off**.

No sound is played with shutter release when some features such as continuous shooting or BSS (best shot selector) are enabled, or when recording movies, even if **On** is selected.

Auto Off

Tap the bottom tab ( 146) →  (Setup menu) →  Auto off

When the camera is on and a period of time passes without any operations having been performed, the monitor will be turned off and the camera will enter standby mode ( 19) to save power.

Choose the time allowed to elapse before the camera enters standby mode if no operations are performed from **30 s**, **1 min** (default setting), **5 min**, and **30 min**.



Press the shutter-release button to cancel standby mode.

Notes on Auto Off



Regardless of the option selected, the monitor will remain on as follows:

- When a setting screen is displayed: three minutes
- During slide show playback: up to 30 minutes

Notes on Auto Off When the Camera is Powered by AC Adapter

- When the AC Adapter EH-62D (available separately;  169) is used, a screen saver function is activated to prevent screen burn if no operations are performed for the time selected for the **Auto off** option (which is fixed to three minutes while a setting screen is displayed). Press the shutter-release button to reactivate the monitor. If no operations are performed for 30 minutes while the screen saver is on, the monitor turns off.
- The images used for the screen saver are the same as those displayed when  is tapped with slide show display ( 98), though no background music is played.
- In the following cases, the monitor turns off without the screen saver function being activated:
 - When no operations are performed for 30 minutes with **30 min** selected for **Auto off**, except when a setting screen is displayed.
 - When a slide show lasts for 30 minutes.
- When the camera is connected to a TV or printer, the screen saver function is not activated and the camera does not enter standby mode even when no operations are performed for an extended period of time.

/ Format Memory/Format Card

Tap the bottom tab ( 146) →  (Setup menu) →  Format memory/ Format card

Use this option to format the internal memory or a memory card.

Formatting the Internal Memory

To format the internal memory, remove the memory card from the camera.

The **Format memory** option is displayed in the setup menu.

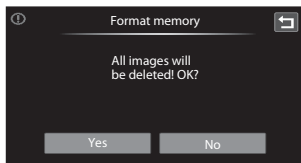

Formatting a Memory Card

When a memory card is inserted in the camera, the **Format card** option is displayed in the setup menu and the memory card is formatted.

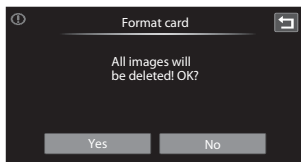

Formatting Internal Memory and Memory Cards

- **Formatting the internal memory or memory cards permanently deletes all data.** Be sure to transfer important pictures to a computer before formatting.
- Formatting the internal memory or memory card restores album icon settings ( 89) to the default setting (displayed as number).
- Do not turn the camera off or open the battery-chamber/memory card slot cover during formatting.
- Be sure to use this camera to format memory cards previously used in other devices the first time they are inserted into the COOLPIX S80.

Language

Tap the bottom tab (📖 146) → ⚙️ (Setup menu) → 🗣️ Language

Choose one of 24 languages for display of camera menus and messages.

Čeština	Czech
Dansk	Danish
Deutsch	German
English	(default setting)
Español	Spanish
Ελληνικά	Greek
Français	French
Indonesia	Indonesian
Italiano	Italian
Magyar	Hungarian
Nederlands	Dutch
Norsk	Norwegian

Polski	Polish
Português	Portuguese
Русский	Russian
Suomi	Finnish
Svenska	Swedish
Türkçe	Turkish
عربي	Arabic
简体中文	Simplified Chinese
繁體中文	Traditional Chinese
日本語	Japanese
한글	Korean
ภาษาไทย	Thai

TV Settings

Tap the bottom tab  146 →  (Setup menu) →  TV settings

Adjust settings for connection to a television.

Video mode

Choose from **NTSC** and **PAL**.

HDMI

Choose a picture resolution for HDMI output from **Auto** (default setting), **480p**, **720p**, or **1080i**. When **Auto** is selected, the option best suited to the high-definition TV to which the camera is connected is automatically selected from **480p**, **720p**, or **1080i**.

HDMI device control

Set whether or not the camera receives signals from an HDMI-CEC compatible television when connected with an HDMI cable. Select **On** (default setting) to use the television's remote control to perform playback operations without using the camera's touch panel. The television's remote control can be used to select pictures, play/pause movies, and switch between full-frame playback and four-thumb nail playback.

- Refer to the documentation supplied with the television for information on the television's HDMI-CEC compatibility.

HDMI and HDMI-CEC

"HDMI" is the abbreviation for High-Definition Multimedia Interface and is one type of multimedia interface. "HDMI-CEC" is the abbreviation for HDMI-Consumer Electronics Control, which enables compatible devices to control each other and allows the user to operate multiple devices with one remote control.

Charge by Computer

Tap the bottom tab ( 146) →  (Setup menu) →  Charge by computer

Choose whether or not the battery inserted into the camera is charged when the camera is connected to a computer via the USB cable ( 137).

Auto (default setting)

When the camera is connected to a computer that is running, the battery inserted into the camera is automatically charged using power supplied by the computer.



Off

The battery inserted into the camera is not charged when the camera is connected to a computer.

Notes on Connecting the Camera to a Printer

- The battery cannot be charged with connection to a printer, even if the printer complies with the PictBridge standard.
- When **Auto** is selected for **Charge by computer**, it may be impossible to print pictures with direct connection of the camera to some printers. If the **PictBridge** startup screen is not displayed in the monitor after the camera is connected to a printer and turned on, turn the camera off and disconnect the USB cable. Set **Charge by computer** to **Off** and reconnect the camera to the printer.

Blink Warning

Tap the bottom tab ( 146) →  (Setup menu) →  Blink warning

Specify whether or not the camera detects human subjects that have blinked with shooting using face detection ( 49) when shooting in the following modes.

-  (easy auto) mode ( 24) or  (auto) mode ( 51)
- **Portrait** ( 64) or **Night portrait** ( 65) is selected for the scene mode.

On

When the camera detects that one or more human subjects may have blinked in a picture taken using face detection, the blink warning screen is displayed in the monitor.

The face of the human subject that may have blinked when the shutter was released is framed by a yellow border. Should this occur, check the picture and determine whether or not another picture should be taken.

See "Operating the Blink Warning Screen" ( 160) for more information.

Off (default setting)

Blink warning is not enabled.

Operating the Blink Warning Screen

When the blink warning screen shown at right is displayed in the monitor, the operations described below are available.

If no operations are performed within a few seconds, the camera automatically returns to shooting mode.





To	Tap	Description
Enlarge the detected face that blinked		Tap . If the camera detects that more than one human subject blinked, tap or to switch display to another face.
Switch to full-frame playback		Tap .
Delete pictures		Tap .
Switch to shooting mode		Tap the monitor or tap or . The shutter-release button can also be pressed to return to shooting mode.

Note on Blink Warning







Blink detection does not function at continuous settings of **Continuous**, **BSS**, or **Multi-shot 16**.

Reset All





Tap the bottom tab ( 146) →  (Setup menu) →  Reset all

When **Reset** is selected, the camera's settings will be restored to their default values.

Basic Shooting Functions

Option	Default value
Flash mode ( 33)	Auto
Self-timer ( 36)	Off
Image mode ( 38)	 3968x2232
Touch shooting ( 41, 44, 55)	Touch shutter
Exposure compensation ( 47)	0.0



Auto Mode

Option	Default value
Macro mode ( 54)	Off
ISO sensitivity ( 57)	Auto
Continuous ( 58)	Single
White balance ( 59)	Auto

Scene Mode

Option	Default value
Scene effect adjustment slider ( 63)	Center

Smart Portrait Mode

Option	Default value
Skin softening ( 74)	Normal
Blink proof ( 75)	Off
Smile timer ( 75)	On

Movie Settings

Option	Default value
Movie options (📖 127)	📺 HD 720p (1280×720)

Playback Mode

Option	Default value
Slide show (📖 98) Effects	Classic

Setup Menu

Option	Default value
Welcome screen (📖 147)	None
Playback (📖 151)	Auto info
Image review (📖 151)	On
Brightness (📖 151)	3
Date imprint (📖 152)	Off
Vibration reduction (📖 153)	On
AF assist (📖 154)	Auto
Digital zoom (📖 154)	On
Button sound (📖 155)	On
Shutter sound (📖 155)	On
Auto off (📖 155)	1 min
HDMI (📖 158)	Auto
HDMI device control (📖 158)	On
Charge by computer (📖 159)	Auto
Blink warning (📖 159)	Off

Others

Option	Default value
Paper size (📖 141, 142)	Default

- Selecting **Reset** also clears the current file number (📖 171) from memory. Numbering will continue from the lowest number available. To reset file numbering to "0001", delete all pictures stored in the internal memory or on the memory card (📖 31) before selecting **Reset**.
- The following settings will remain unaffected even when **Reset all** is set to **Reset**.
Shooting settings: Preset manual data (📖 60) acquired for **White balance**
Setup menu: Date (📖 148), **Language** (📖 157), and **TV settings** (📖 158)

☰ Copy (Copy between Internal Memory and Memory Card)

Tap the bottom tab (📖 146) → 🧑 (Setup menu) → ☰ Copy

Copy pictures between the internal memory and a memory card.

- 1 Tap a destination option to which pictures are copied in the copy screen.

📁 → 📷: Copy pictures from internal memory to memory card.

📷 → 📁: Copy pictures from memory card to internal memory.

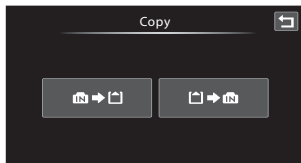

- 2 Tap a copy option.

Selected images: Copy pictures selected. Proceed to step 3.

All images: Copy all pictures. When a confirmation dialog is displayed, tap **Yes**. Pictures are copied. To return to the setup menu without copying, tap **No**.

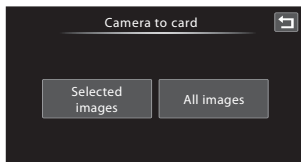

- 3 Tap the pictures to be copied.

When a picture is selected, a check mark is displayed. To cancel the selection, tap the picture again. A check mark is removed.

Tap 🔍 to switch to full-frame playback and tap 📷 to switch back to 9-thumbnail display.

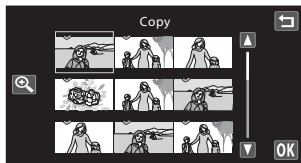

- 4 Tap **OK**.

When a confirmation dialog is displayed, tap **Yes**. Pictures are copied. To return to the setup menu without copying, tap **No**.

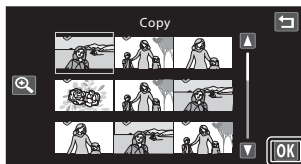

✓ Notes on Copying Pictures

- JPEG-, MOV-, and WAV-format files can be copied. Files recorded in any other format cannot be copied.
- If voice memos (📖 107) are attached to pictures selected for copying, voice memos are copied with the pictures.
- Operation is not guaranteed with pictures taken with another make of camera or that have been modified on a computer.
- When pictures selected for a print order (📖 102) are copied, print marking is not copied with pictures (copies will not be included in the print order). However, rating (📖 97) and Protect (📖 100) settings are copied with pictures.
- Pictures or movies copied from the internal memory or a memory card cannot be displayed in auto sort mode (📖 91).
- When a picture that has been added to an album (📖 84) is copied, information specifying the album to which the original picture was added is not copied.

📎 “Memory contains no images.” Message

If there are no pictures stored on the memory card when playback mode is applied, the message **Memory contains no images.** will be displayed. Perform the followings to copy pictures in the internal memory to a memory card.

1. Tap the bottom tab to display the setting controls and tap 🏠.
2. Tap **Copy** in the displayed setup menu.

🔍 More Information

See “Image/Sound File and Folder Names” (📖 171) for more information.

Ver. Firmware Version

Tap the bottom tab (📖 146) → 🏠 (Setup menu) → Ver. Firmware version

View the current camera firmware version.

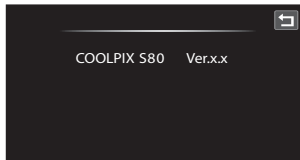

Maximizing Camera Life and Performance

To ensure continued enjoyment of this Nikon product, observe the following precautions when using or storing the device.

Keep Dry

The device will be damaged if immersed in water or subjected to high humidity.

Do not Drop

The product may malfunction if subjected to strong shock or vibration.

Handle the Lens and All Moving Parts with Care

Do not apply force to the lens, monitor, memory card slot or battery-chamber. These parts are easily damaged. Applying force to the lens cover could result in camera malfunction or damage to the lens. Should the monitor break, care should be taken to avoid injury caused by broken glass.

Do not Point the Lens at Strong Light Sources for Extended Periods

Avoid pointing the lens at the sun or other strong light sources for extended periods when using or storing the camera. Intense light may cause deterioration of the CCD image sensor, producing a white blur effect in photographs.

Keep Away from Strong Magnetic Fields

Do not use or store this device in the vicinity of equipment that generates strong electromagnetic radiation or magnetic fields. Strong static charge or the magnetic fields produced by equipment such as radio transmitters could interfere with the monitor, damage data stored on the memory card, or affect the product's internal circuitry.

Avoid Sudden Changes in Temperature

Sudden changes in temperature, such as when entering or leaving a heated building on a cold day, can cause condensation to form inside the device. To prevent condensation, place the device in a carrying case or a plastic bag before exposing it to sudden changes in temperature.

Turn the Product Off before Removing or Disconnecting the Power Source

Do not remove the battery while the product is on, or while images are being recorded or deleted. Forcibly cutting power in these circumstances could result in loss of data or in damage to product memory or internal circuitry.

 **The Battery**

- Check the battery level before using the camera and replace or charge the battery if necessary. Do not continue charging once the battery is fully charged as this will result in reduced battery performance. Whenever possible, carry a fully charged spare battery when taking pictures on important occasions.
- Do not use the battery at ambient temperatures below 0 °C (32 °F) or above 40 °C (104 °F).
- Charge the battery indoors with an ambient temperature of 5 °C to 35 °C (41 °F to 95 °F) before use.
- When charging the COOLPIX S80 using the Charging AC adapter EH-68P or a computer, the charge capacity may decrease at ambient temperatures 45 °C to 60 °C (113 °F to 140 °F).
- The battery is not charged at ambient temperatures below 0 °C (32 °F) or above 60 °C (140 °F).
- Note that the battery may become hot during use; wait for the battery to cool before charging. Failure to observe these precautions could damage the battery, impair its performance or prevent it from charging normally.
- On cold days, the capacity of batteries tends to decrease. Be sure that the battery is fully charged before heading outside to take pictures in cold weather. Keep spare batteries in a warm place and exchange as necessary. Once warmed, a cold battery may recover some of its charge.
- Dirt on the battery terminals can prevent the camera from functioning. Should the battery terminals become dirty, wipe them off with a clean, dry cloth before use.
- If the battery will not be used for some time, insert it in the camera and run it flat before removing it for storage. The battery should be stored in a cool location with an ambient temperature of 15 to 25 °C (59 to 77 °F). Do not store the battery in hot or extremely cold locations.
- Always remove the battery from the camera or Charging AC Adapter when it is not being used. When inserted, minute amounts of current are drawn from the battery even when not in use. This may result in excessive draining of the battery and complete loss of function. Turning the camera on or off while the battery is exhausted can result in reduced battery life.
- Recharge the battery at least once every six months and completely exhaust it before returning it to storage.
- After removing the battery from the camera or Charging AC Adapter, replace the supplied battery case and store in a cool place.
- A marked drop in the time a fully-charged battery retains its charge, when used at room temperature, indicates that the battery needs to be replaced. Purchase a new EN-EL10 battery.
- Replace the battery when it no longer holds a charge. Used batteries are a valuable resource. Please recycle used batteries in accordance with local regulations.

Cleaning

Lens	Avoid touching glass parts with your fingers. Remove dust or lint with a blower (typically a small device with a rubber bulb attached to one end that is pumped to produce a stream of air out the other end). To remove fingerprints or other stains that cannot be removed with a blower, wipe the lens with a soft cloth, using a spiral motion that starts at the center of the lens and working toward the edges. If this fails, clean the lens using a cloth lightly dampened with commercial lens cleaner.
Monitor	Remove dust or lint with a blower. To remove fingerprints and other stains, clean the monitor with a soft, dry cloth, being careful not to apply pressure.
Body	Use a blower to remove dust, dirt or sand, then wipe gently with a soft, dry cloth. After using the camera at the beach or other sandy or dusty environment, wipe off any sand, dust or salt with a dry cloth lightly dampened with fresh water and dry thoroughly. Note that foreign matter inside the camera could cause damage not covered by the warranty.

Do not use alcohol, thinner, or other volatile chemicals.

Storage

Turn the camera off when not in use. Be sure that the power-on lamp is off before putting the camera away. Remove the battery if the camera will not be used for an extended period. Do not store the camera with naphtha or camphor moth balls, or in any of the following locations:

- Next to equipment that produces strong electromagnetic fields, such as televisions or radios
- Exposed to temperatures below -10°C (14°F) or above 50°C (122°F)
- Places that are poorly ventilated or subject to humidity of over 60%

To prevent mold or mildew, take the camera out of storage at least once a month. Turn the camera on and release the shutter a few times before putting the camera away again.

Notes on the Monitor

- The monitor may contain a few pixels that are always lit or that do not light. This does not indicate a malfunction. Images recorded using the product will not be affected.
- Due to the general characteristics of OLED monitors, prolonged or repeated display of the same screen or image may result in screen burn. Screen burn can be recognized by decreased brightness in portions of the monitor or mottled display. In some cases, screen burn may become permanent. However, pictures are in no way affected by screen burn.
To prevent screen burn, do not set monitor brightness higher than necessary and do not display the same screen or image for an extended period of time.
- White or colored streaks of light may be visible in the monitor with framing of bright subjects. This phenomenon, known as “smear,” occurs when extremely bright light strikes the image sensor. This is due to characteristics of the image sensor and does not indicate a malfunction. Smear may also cause partial discoloration in monitor display with shooting.
Smear does not affect recorded images except when shooting with **Continuous** set to **Multi-shot 16** and when recording movies. When shooting in these modes, avoiding bright objects such as the sun, reflections of the sun, and electric lights is recommended.
- Images in the monitor may be difficult to see under bright lighting.
- The monitor is lit by an LED backlight. Should the monitor begin to dim or flicker, contact your Nikon-authorized service representative.

Optional Accessories

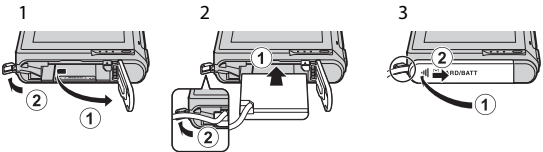
Rechargeable battery	Rechargeable Li-ion Battery EN-EL10
Charging AC adapter	Charging AC Adapter EH-68P*, EH-68P (AR)*
Battery charger	Battery Charger MH-63
AC adapter	<p>AC Adapter EH-62D</p> <p>Connecting the EH-62D</p>  <p>Be sure that the AC adapter cord has been properly aligned in the grooves of the AC adapter and the battery chamber before closing the battery-chamber/memory card slot cover. If the cord is not properly aligned in the groove, the cover may be damaged when it is closed.</p>
USB cable	USB Cable UC-E6
Audio/Video cable	Audio Video Cable EG-CP16



* When using in other countries, use a plug adapter (available commercially) as necessary. For more information about plug adapters, consult your travel agency.

Approved Memory Cards

The following Secure Digital (SD) memory cards have been tested and approved for use in this camera.

- Memory cards with an SD Speed Class rating of 6 or faster are recommended for recording movies. Movie recording may stop unexpectedly when memory cards with a lower Speed Class rating are used.

	SD memory card	SDHC memory card ²	SDXC memory card ³
SanDisk	2 GB ¹	4 GB, 8 GB, 16 GB, 32 GB	64 GB
TOSHIBA	2 GB ¹	4 GB, 8 GB, 16 GB, 32 GB	64 GB
Panasonic	2 GB ¹	4 GB, 8 GB, 12 GB, 16 GB, 24 GB, 32 GB	48 GB, 64 GB
Lexar	2 GB ¹	4 GB, 8 GB, 16 GB, 32 GB	–



- If the memory card is used with a card reader or similar device, be sure that the device supports an SD memory card of 2 GB or more.
- SDHC compliant. When using the memory card with a card reader or similar device, be sure that the device is compliant with the SDHC standard. 
- SDXC compliant. When using the memory card with a card reader or similar device, be sure that the device is compliant with the SDXC standard. 

Contact the manufacturer for details on the above cards.

Image/Sound File and Folder Names

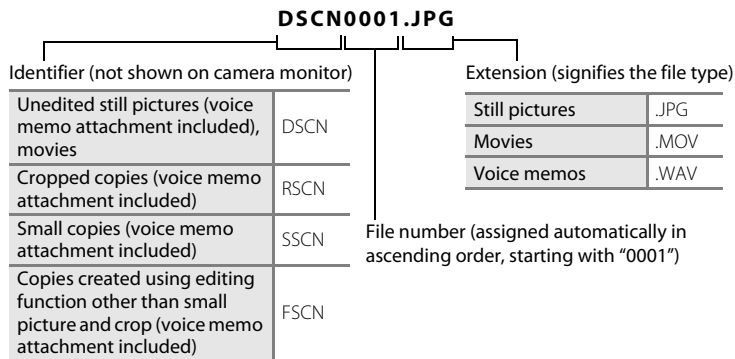







Pictures, movies, or voice memos are assigned file names as follows.









- Files are stored in folders named with a folder number followed by an identifier: "P_" plus a three-digit sequential number for pictures taken in **Panorama assist** scene mode (e.g. "101P_001";  70), and "NIKON" for all other pictures (e.g. "100NIKON"). When the number of files within a folder reaches 9999, a new folder will be created. File numbers will be assigned automatically starting with "0001."
- Voice memo file names have the same identifier and file number as the picture to which the voice memo is attached.
- Files copied using **Copy>Selected images** are copied to the current folder, where they are assigned new file numbers in ascending order starting from the largest file number in memory. **Copy>All images** copy all folders from the source medium; file names do not change but new folder numbers are assigned in ascending order, starting from the largest folder number on the destination medium ( 164).
- A single folder can hold up to 200 pictures; if the current folder already contains 200 pictures, a new folder, named by adding one to the current folder name, will be created the next time a picture is taken. If the current folder is numbered 999 and contains 200 pictures, or a picture is numbered 9999, no further pictures can be taken until the internal memory or memory card is formatted ( 156), or a new memory card is inserted.

Error Messages











The following table lists the error messages and other warnings displayed in the monitor, as well as the solutions for dealing with them.

Display	Problem	Solution	
 (blinks)	Clock not set.	Set date and time.	148
	Battery running low.	Prepare to charge or replace battery.	14
 Battery exhausted.	Battery exhausted.	Charge or replace battery.	14
 Battery temperature high	Battery temperature is high.	Turn off camera, and allow battery to cool down before resuming use. When this message appears, the power-on lamp blinks rapidly for five seconds and the monitor turns off.	19
 The camera will turn off to prevent overheating.	Inside of the camera or the memory card has become hot. The camera turns off automatically.	Leave the camera off until the inside of the camera or the memory card has cooled and then turn it on again.	–
 ● (● blinks red)	Camera cannot focus.	<ul style="list-style-type: none"> • Refocus. • Focus on another subject positioned at the same distance from the camera as the intended subject. 	28, 29 46
 Please wait for the camera to finish recording.	Camera cannot perform other operations until recording is complete.	Wait until message clears from display automatically when recording is complete. Do not open the battery-chamber/memory card slot cover during recording.	–
 Memory card is write protected.	Write-protect switch is in “lock” position.	Slide write-protect switch to “write” position.	23







Display	Problem	Solution	
 This card cannot be used.	Error accessing memory card.	<ul style="list-style-type: none"> • Use approved card. • Check that terminals are clean. • Confirm that memory card is correctly inserted. 	170
 This card cannot be read.			22
 Card is not formatted. Format card? Yes No	Memory card has not been formatted for use in COOLPIX S80.	Formatting deletes all data stored on the memory card. Be sure to select No and make copies of any pictures which need to be kept before formatting the memory card. Tap Yes to format.	23
 Out of memory.	Memory card is full.	<ul style="list-style-type: none"> • Choose smaller image size. • Delete pictures. • Insert new memory card. • Remove memory card and use internal memory. 	38 31, 88, 93, 95 22 22
 Image cannot be saved.	Error occurred while recording picture.	Format internal memory or memory card.	156
	Camera has run out of file numbers.	<ul style="list-style-type: none"> • Insert new memory card. • Format internal memory or memory card. 	22 156
	Picture cannot be used for the welcome screen.	Pictures reduced to 320 x 240 size or smaller with small picture editing or cropping or pictures taken with cameras other than the COOLPIX S80 cannot be registered as welcome screen.	122, 123
	Insufficient space to save a copy.	Delete pictures from destination.	31

Error Messages

Display	Problem	Solution	
i Album is full. No further pictures can be added.	200 pictures have already been added to album.	<ul style="list-style-type: none"> Remove some pictures from album. Add to other albums. 	87 84
i A blink was detected in the picture just taken.	One or more portrait subjects may have blinked when the picture was taken.	Check the picture in playback mode.	75
i Image cannot be modified.	Cannot edit selected picture.	Select pictures that support editing functions.	109
i Cannot record movie.	Time out error while recording movie on the memory card.	Choose memory card with faster write speed.	125, 170
i Memory contains no images.	No pictures in the internal memory or memory card.	<ul style="list-style-type: none"> Remove the memory card from the camera to play back pictures stored in the camera's internal memory. To copy pictures from internal memory to memory card, display the setup menu and select Copy. 	22 164
	The picture has not been added to album.	<ul style="list-style-type: none"> Add pictures to album. Choose the album to which picture was added. 	84 86
	No pictures are contained in the category selected in auto sort mode.	Select the category containing the sorted pictures.	92
i File contains no image data.	File not created with COOLPIX S80.	Use the computer or other device with which the file was created or edited for playback.	-
i This file cannot be played back.			

Display	Problem	Solution	
 All images are hidden.	No pictures available for a slide show.	–	–
 This image cannot be deleted.	Picture is protected.	Disable protection.	101
 Travel destination is in the current time zone.	Destination in same time zone as home.	–	148
 Rating maximum reached. No further pictures can be rated.	Over 999 pictures have already been rated.	Cancel the rating setting of them.	97
 No images with this rating found.	There are no pictures with the selected rating.	<ul style="list-style-type: none"> • Apply the rating to pictures. • Select a rating that has been applied to pictures. 	97
Lens cover error 	Lens error.	Turn camera off and then on again. If error persists, contact retailer or Nikon-authorized service representative.	19, 24
 Initializing lens. Cannot focus.	The camera cannot focus.	Wait for the camera to recover automatically.	–
 Communications error	USB cable disconnected during data transfer to printer.	Turn camera off, reconnect USB cable.	139
System error 	Error has occurred in camera's internal circuitry.	Turn camera off, remove and reinsert battery, and turn camera on. If error persists, contact retailer or Nikon-authorized service representative.	14, 24
 Printer error: check printer status.	Printer error.	Check printer. After solving the problem, tap Resume to resume printing.*	–

Error Messages

Display	Problem	Solution	
 Printer error: check paper	Specified size of paper is not loaded in printer.	Load the specified paper, and tap Resume to resume printing.*	–
 Printer error: paper jam	Paper has jammed in the printer.	Eject the jammed paper, and tap Resume to resume printing.*	–
 Printer error: out of paper	No paper is loaded in printer.	Load the specified paper, and tap Resume to resume printing.*	–
 Printer error: check ink	Ink error.	Check ink, and tap Resume to resume printing.*	–
 Printer error: out of ink	Ink cartridge is empty.	Replace ink cartridge, and tap Resume to resume printing.*	–
 Printer error: file corrupt	An error caused by the image file has occurred.	Tap Cancel to cancel printing.	–

* See the documentation provided with your printer for further guidance and information.



Troubleshooting



If the camera fails to function as expected, check the list of common problems below before consulting your retailer or Nikon-authorized service representative.







Display, Settings and Power Supply

Problem	Cause/Solution	
Monitor is blank	• Camera is off.	24
	• Battery is exhausted.	24
	• Standby mode for saving power: press the shutter-release button halfway.	19, 155
	• Camera and computer are connected via the USB cable.	133
	• Camera and TV are connected via audio/video cable or HDMI cable.	129
Monitor is hard to read/has darkened	• When connecting to an electrical outlet using a Charging AC Adapter, the camera cannot be turned on.	16
	• Adjust monitor brightness.	151
	• When the internal temperature of the camera is high, the monitor darkens to reduce heat generation. When internal temperature cools, the monitor brightens again.	–
	• When the power-on lamp is covered after the camera has automatically increased monitor brightness, the monitor may darken.	–
Camera turns off without warning	• Monitor is dirty. Clean monitor.	166
	• Battery is exhausted.	24
	• If connecting the Charging AC Adapter while the camera is on, the camera is turned off.	16
	• The USB cable connecting the camera to the computer or printer has been disconnected. Reconnect the USB cable.	133, 139
	• The internal temperature of the camera or the memory card is high. Allow the camera and memory card to cool and turn on the camera again.	172
• The camera and battery may not work properly at low temperatures.	167	

Shooting

Problem	Cause/Solution	
No picture taken.	<ul style="list-style-type: none"> • When camera is in playback mode, or setting items or setup menu are displayed, press the shutter-release button. • Battery is exhausted. • When flash indicator blinks, flash is charging. 	30 24 34
Cannot switch to shooting mode.	Disconnect HDMI cable, audio/video cable, or USB cable.	129
Camera cannot focus.	<ul style="list-style-type: none"> • The intended subject is one with which autofocus does not perform well. • Set AF assist in the setup menu to Auto. • Turn camera off and then on again. 	29 154 24
Pictures are blurred.	<ul style="list-style-type: none"> • Use flash. • Increase ISO sensitivity value. • Enable vibration reduction. • Use BSS (Best Shot Selector). • Use tripod and self-timer. 	33 57 153 58 36
Bright specks appear in pictures taken with flash.	Flash is reflecting off particles in air. Set the flash mode setting to  (off).	33
Streaks of light or partial discoloration are visible in the monitor.	Smear occurs when extremely bright light strikes the image sensor. When shooting with Continuous set to Multi-shot 16 and when recording movies, avoiding bright objects, such as the sun, reflections of the sun, and electric lights is recommended.	168
Flash does not fire.	<ul style="list-style-type: none"> • The flash mode setting is set to  (off). • Scene mode with which the flash does not fire is selected. • On is selected for Blink proof in smart portrait mode. • Movie is selected for shooting mode. • Another function that restricts flash is enabled. 	33 62 75 124 76



Problem	Cause/Solution	
Digital zoom cannot be used.	<ul style="list-style-type: none"> • Digital zoom is set to Off in the setup menu. • Digital zoom is not available in the following situations. <ul style="list-style-type: none"> - When Portrait or Night portrait scene mode is selected - Touch shooting is set to Subject tracking - When shooting in smart portrait mode - When Multi-shot 16 is selected for the Continuous setting 	154 64, 65 55 72 58
Image mode not available.	Another function that restricts the Image mode option is enabled.	76
No sound when the shutter is released.	<ul style="list-style-type: none"> • Off is selected for Sound settings>Shutter sound in the setup menu. No sound is heard with some shooting modes and settings, even when On is selected. • The speaker is blocked. Do not cover the speaker. 	155 5
AF-assist illuminator does not light.	Off is selected for the AF assist option in the setup menu. AF-assist illuminator may not light depending on the position of the focus area or the current scene mode, even when Auto is selected.	64-69, 154
Pictures appear smeared.	Lens is dirty. Clean lens.	166
Colors are unnatural.	White balance does not match light source.	59
Randomly spaced bright pixels ("noise") appear in image.	Shutter speed too slow or ISO sensitivity is high as the subject is dark. Noise can be reduced by: <ul style="list-style-type: none"> • Using flash • Specifying a lower ISO sensitivity setting 	33 57
Pictures are too dark (underexposed).	<ul style="list-style-type: none"> • The flash mode setting is set to  (off). • Flash window is blocked. • Subject is beyond flash range. • Adjust exposure compensation. • Increase the ISO sensitivity. • Subject is backlit. Select Backlighting scene mode or set the flash mode setting to  (fill flash). 	33 26 33 47 57 33, 69
Pictures are too bright (overexposed).	Adjust exposure compensation.	47

Problem	Cause/Solution	
Unexpected results when flash set to  (auto with red-eye reduction).	When taking pictures with  (auto with red-eye reduction) or fill flash with slow sync and red-eye reduction in Night portrait scene mode, In-Camera Red-Eye Fix may be applied to areas not affected by red-eye. Use any scene mode other than Night portrait , and change the flash mode to any setting other than  (auto with red-eye reduction) and try taking a picture again.	33, 65
Skin tones are not softened.	• Under some shooting conditions, facial skin tones may not be softened.	73
	• Select  (skin softening) for Glamour retouch in the retouch menu for pictures containing four or more faces.	120
Saving images takes time.	It may take more time to save images in the following situations.	
	• When the noise reduction function is in operation	34
	• When flash mode is set to  (auto with red-eye reduction)	35
	• When the skin softening function is applied while shooting	64, 65, 74

Playback

Problem	Cause/Solution	
File cannot be played back.	• File or folder was overwritten or renamed by computer or other make of camera.	–
	• The COOLPIX S80 is not able to playback movies recorded with another make or model of digital camera.	128
Cannot zoom in on picture.	Playback zoom cannot be used with movies, small pictures, or pictures that have been cropped to a size of 320 × 240 or smaller.	–
Cannot record or play back voice memo.	• Voice memos cannot be attached to movies. • Voice memos cannot be attached to pictures taken with other cameras. Voice memos attached to pictures using another camera cannot be played back on this camera.	128 108

Problem	Cause/Solution	
Cannot edit pictures.	<ul style="list-style-type: none"> • These options cannot be used with movies. 128 • Select pictures that support editing functions. 109 • Pictures taken with another make or model of camera cannot be edited. 109 • Pictures edited with this camera may not be displayed correctly on other cameras and cannot be transferred to computers from other cameras. 109 	
Pictures not displayed on television.	<ul style="list-style-type: none"> • Select the correct Video mode and HDMI options from the TV settings item. 158 • Both HDMI cable and audio/video cable or USB cable are connected to the camera. 129 • Memory card contains no pictures. Replace memory card. Remove memory card to play back pictures recorded in the internal memory. 22 	
Album icon restored to default settings, or pictures added to album not displayed in favorite pictures mode.	Data in the memory card may not be played back correctly if overwritten by a computer.	–
The recorded pictures are not displayed in auto sort mode.	<ul style="list-style-type: none"> • The desired picture was sorted to a category other than the category currently displayed. 92 • Pictures recorded by a camera other than the COOLPIX S80 and pictures copied using the Copy option cannot be displayed in auto sort mode. 164 • Pictures recorded in the internal memory or on the memory card may not be played back correctly if overwritten by a computer. – • Up to 999 pictures and movies in total can be added to each category. If the desired category already contains 999 pictures or movies in total, new pictures or movies cannot be added. 92 	
Nikon Transfer 2 does not start when camera is connected.	<ul style="list-style-type: none"> • Camera is off. 19 • Battery is exhausted. 24, 133, 137 • USB cable is not correctly connected. 133, 137 • Confirm the compatible operating systems. 132 • Camera is not recognized by the computer. – • Refer to help information contained in ViewNX 2. – 	

Problem	Cause/Solution	
<p>The PictBridge startup screen is not displayed when the camera is connected to a printer.</p>	<p>With some PictBridge-compatible printers, the PictBridge startup screen may not be displayed and it may be impossible to print pictures when Auto is selected for the Charge by computer option in the setup menu. Set the Charge by computer option to Off and reconnect the camera to the printer.</p>	159
<p>Pictures to be printed are not displayed.</p>	<ul style="list-style-type: none"> • Memory card contains no pictures. Replace the memory card. • Remove the memory card to print pictures from the internal memory. 	22
<p>Cannot select paper size with camera.</p>	<p>Paper size cannot be selected from the camera in the following situations, even when printing from a PictBridge-compatible printer:</p> <ul style="list-style-type: none"> • The printer does not support the paper sizes specified by the camera. • The printer automatically selects the paper size. 	141, 142
<p>Edge of printed picture is cropped.</p>	<ul style="list-style-type: none"> • When printing pictures taken at an Image mode setting of  3968x2232 (default setting), the edges of pictures may be cropped, preventing printing of complete pictures. Refer to the documentation supplied with the printer or consult the digital photo lab for further details to make sure that the printer supports printing at an aspect ratio of 16:9. • Take pictures at the Image mode setting other than  3968x2232. 	138 38



Specifications

Nikon COOLPIX S80 Digital Camera

Type	Compact digital camera
Effective pixels	14.1 million
Image sensor	$\frac{1}{2.3}$ -in. type CCD; total pixels: approx. 14.48 million
Lens	5 \times optical zoom, NIKKOR lens
Focal length	6.3-31.5mm (angle of view equivalent to that of 35-175 mm lens in 35mm [135] format)
f/-number	f/3.6-4.8
Construction	13 elements in 10 groups
Digital zoom	Up to 4 \times (angle of view equivalent to that of approx. 700 mm lens in 35mm [135] format)
Vibration reduction	Combination of lens-shift and electronic VR (still pictures) Lens-shift (movies)
Autofocus (AF)	Contrast-detect AF
Focus range (from lens)	<ul style="list-style-type: none">• Approx. 30 cm (1 ft.) to ∞ (W); approx. 50 cm (1 ft. 8 in.) to ∞ (T)• Macro mode: 7 cm (2.8 in.) to ∞ (wide-angle zoom position)
Focus-area selection	Face priority, Auto (9-area automatic selection), center, manual (focus area can be selected using the touch panel), subject tracking
Monitor	8.7 cm (3.5-in.), widescreen, OLED (touch panel) with anti-reflection coating, approx. 819k-dot, 5-level brightness adjustment
Frame coverage (shooting mode)	Approx. 97% horizontal and 97% vertical (Compared to actual picture)
Frame coverage (playback mode)	Approx. 100% horizontal and 100% vertical (Compared to actual picture)
Storage	
Media	<ul style="list-style-type: none">• Internal memory (approx. 79 MB)• SD/SDHC/SDXC memory card
File system	DCF, Exif 2.2, and DPOF compliant
File formats	Still pictures: JPEG Sound files (Voice Memo): WAV Movies: MOV (video: MPEG-4 AVC/H.264, audio: AAC stereo)
Image size (pixels)	<ul style="list-style-type: none">• 14M (high image quality) [4320 \times 3240★]• 14M [4320 \times 3240]• 8M [3264 \times 2448]• 5M [2592 \times 1944]• 3M [2048 \times 1536]• PC [1024 \times 768]• VGA [640 \times 480]• 16:9 [3968 \times 2232]

ISO sensitivity (Standard output sensitivity)	<ul style="list-style-type: none"> • ISO 80, 100, 200, 400, 800, 1600, 3200, 6400 • Auto (auto gain from ISO 80 to 800) • Fixed range auto (ISO 80 to 200, ISO 80 to 400)
Exposure	
Metering	256-segment matrix, center-weighted (digital zoom less than 2x), spot (digital zoom 2x or more)
Exposure control	Programmed auto exposure with motion detection and exposure compensation (–2.0 to +2.0 EV in steps of $\frac{1}{3}$ EV)
Shutter	Mechanical and charge-coupled electronic shutter
Speed	$\frac{1}{1500}$ -2 s, 4 s (Fireworks show scene mode)
Aperture	Electronically-controlled ND filter (–2.3 AV) insertion
Range	2 steps (f/3.6 and f/8.1 [W])
Self-timer	Can be selected from 10 and 2 second durations
Built-in flash	
Range (approx.) (ISO sensitivity: Auto)	[W]: 0.5 to 4.0 m (1 ft. 8 in. to 13 ft.) [T]: 0.5 to 2.5 m (1 ft. 8 in. to 8 ft. 2 in.)
Flash control	TTL auto flash with monitor preflashes
Interface	Hi-Speed USB
Data Transfer Protocol	MTP, PTP
Video output	Can be selected from NTSC and PAL
HDMI output	Can be selected from Auto , 480p , 720p , and 1080i
I/O terminal	Audio video output/digital I/O (USB) HDMI mini connector (Type C) (HDMI output)
Supported languages	Arabic, Chinese (Simplified and Traditional), Czech, Danish, Dutch, English, Finnish, French, Greek, German, Hungarian, Indonesian, Italian, Japanese, Korean, Polish, Portuguese, Norwegian, Russian, Spanish, Swedish, Thai, Turkish
Power sources	One EN-EL10 Rechargeable Li-ion Battery (supplied) AC Adapter EH-62D (available separately)
Charging time	Approx. 3 hours (with Charging AC Adapter EH-68P/EH-68P (AR) when battery is fully discharged)
Battery life (EN-EL10)	Still pictures*: Approx. 150 shots Movies: Approx. 1 h 5 min (HD 720p (1280x720))
Tripod socket	$\frac{1}{4}$ (ISO 1222)
Dimensions (W x H x D)	Approx. 98.8 x 62.6 x 16.5 mm (3.9 x 2.5 x 0.7 in.) (excluding projections)

Specifications

Weight	Approx. 133 g (4.7 oz) (including battery and SD memory card)
Operating environment	
Temperature	0 to 40 °C (32 to 104 °F)
Humidity	Less than 85% (no condensation)

- Unless otherwise stated, all figures are for a camera with a fully-charged Rechargeable Li-ion Battery EN-EL10 operated at an ambient temperature of 25 °C (77 °F).

* Based on Camera and Imaging Products Association (CIPA) standards for measuring the life of camera batteries. Measured at 23 (±2) °C (73 (±4) °F); zoom adjusted with each shot, flash fired with every other shot, image mode set to  **3968×2232**. Battery life may vary depending upon shooting interval and length of time menus and images are displayed.

Rechargeable Li-ion Battery EN-EL10

Type	Rechargeable lithium-ion battery
Rated capacity	DC 3.7 V, 740 mAh
Operating temperature	0 to 40 °C (32 to 104 °F)
Dimensions (W × H × D)	Approx. 31.5 × 39.5 × 6 mm (1.2 × 1.6 × 0.2 in.) (excluding projections)
Weight	Approx. 15 g (0.5 oz) (excluding battery case)

Charging AC Adapter EH-68P/EH-68P (AR)

Rated input	AC 100-240 V, 50/60 Hz, 0.065-0.04 A
Rated capacity	6.5-9.6 VA
Rated output	DC 5.0 V, 0.5 A
Operating temperature	0 to 40 °C (32 to 104 °F)
Dimensions (W × H × D)	
EH-68P	Approx. 55 × 22 × 65 mm (2.2 × 0.9 × 2.6 in.) (excluding plug adapter)
EH-68P (AR)	Approx. 55 × 51.6 × 66 mm (2.2 × 2.0 × 2.6 in.)
Weight	
EH-68P	Approx. 60 g (2.1 oz) (excluding plug adapter)
EH-68P (AR)	Approx. 65 g (2.3 oz)

Specifications

Nikon will not be held liable for any errors this manual may contain. The appearance of this product and its specifications are subject to change without notice.

Supported Standards

- **DCF:** Design Rule for Camera File System is a standard widely used in the digital camera industry to ensure compatibility among different makes of camera.
- **DPOF:** Digital Print Order Format is an industry-wide standard that allows pictures to be printed from print orders stored on memory cards.
- **Exif version 2.2:** This camera supports Exchangeable Image File Format for Digital Still Cameras (Exif) version 2.2 for digital still cameras, a standard that allows information stored with photographs to be used for optimal color reproduction when images are output from Exif-compliant printers.
- **PictBridge:** A standard developed cooperatively by the digital camera and printer industries, allowing photographs to be output directly to a printer without connecting the camera to a computer.

Index

Symbols

 Easy auto mode 24, 49

 Auto mode 51

 Scene mode 61

 Smart portrait mode 72

 Movie 124

 Playback mode 30

 Favorite pictures mode 84

 Auto sort mode 91

 List by date mode 94

 Setup menu 145

 (tele) 27

 (wide) 27

 Exit icon 12

 Return icon 12

 AE/AF-L 71

A

AC adapter 169

AF-assist illuminator 4, 29, 154

Aperture 28

Audio/video cable 129

Audio-in/Video-in jack 129

Auto flash 33

Auto mode 51

Auto off 155

Auto sort mode 91

Autofocus 29

B

Backlighting  69

Battery 14, 16, 149

Battery charger 169

Battery latch 4

Battery level 24

Battery-chamber 4

Battery-chamber/memory card slot cover
4, 14, 22

Beach  65

Best Shot Selector 58

Blink proof 75

Blink warning 159

Brightness 151

BSS 58

Built-in microphone 4

Button sound 155

C

Charge by computer 159

Charging AC Adapter EH-68P 16

Close-up  67

Cloudy 59

Computer 132

 copying pictures to 132

Connector cover 5

Copy  68

Crop 123

D

Date 20, 148

Date counter 153

Date imprint 152

Daylight 59

Daylight saving time 20, 149

Delete 31, 108

Digital zoom 27, 154

Direct print 138

D-Lighting 115

DPOF 187

 printing 144

Drag 6

Drag and drop 7

Dusk/dawn  66

E

Easy auto mode 24, 49

EH-68P/EH-68P (AR) 16

EN-EL10 14, 16

Exposure compensation 47

Extension 171









Eyelet for camera strap 4

E

Face detection 26, 49

File names 171



Fill flash 33

- Filter effects 118
- Fireworks show  68
- Firmware version 165
- Fixed range auto 57
- Flash 4, 33
- Flash indicator 34
- Flash off 33
- Fluorescent 59
- Focus 5, 28
 - area 8, 28, 49
 - indicator 28
- Folder name 171
- Food  67
- Format 23, 156
- Format memory card 23, 156
- Formatting internal memory 156
- G**
- Glamour retouch 120
- H**
- Halfway 5
- HDMI cable 129
- HDMI device control 158
- Help 61
- I**
- Identifier 171
- Image mode 38
- Incandescent 59
- Internal memory indicator 25
- ISO sensitivity 57
- J**
- JPG 171
- L**
- Landscape  64
- Language 157
- Lens 4, 184
- Li-ion rechargeable battery 14, 16
- List by date mode 94
- M**
- Macro mode 54
- Memory capacity 39
- Memory card 22, 170
- Memory card slot 4, 22
- Monitor 5, 8, 168
- Monitor settings 151
- MOV 171
- Movie options 127
- Movie playback 128
- Multi connector 139
- Multi-shot 16 58
- Museum  68
- N**
- Night landscape  66
- Night portrait  65
- Nikon Transfer 2 132, 133
- Number of exposures remaining 39
- O**
- Optional accessories 169
- P**
- Paint 111
- Panorama assist  69, 70
- Panorama Maker 5 132, 136
- Paper size 141, 142
- Party/indoor  65
- Perspective control 117
- PictBridge 138, 187
- Playback 30, 78, 79, 81, 108, 128, 151
- Playback mode 83
- Playback zoom 81
- Portrait  64
- Power 20, 24
- Power switch (slide cover) 4, 19, 24
- Power-on lamp 4, 17, 19, 137
- Print 102, 141, 142
- Print set 102
- Printer 138
- Protect 100
- Q**
- Quick retouch 114
- R**
- Rating 97

Index

Rechargeable battery 169
Rechargeable Li-ion battery 14
Record orientation 155
Recording movies 124
Red-eye reduction 33, 35
Reset all 161
Rotate image 106

S

Scene mode 61, 64
Self-timer 36
Self-timer lamp 4, 37, 73
Setup menu 145
Shooting 24, 26, 28
Shooting mode 48
Shutter sound 155
Shutter speed 28
Shutter-release button 4, 28
Single 58
Skin softening 74
Slide cover (power switch) 4, 19, 24
Slide show 98
Slow Sync 33
Small picture 122
Smile timer 75
Snow  66
Sound settings 155
Speaker 5
Sports  64
Strap 4
Stretch 116
Subject tracking 55
Sunset  66

T

Tap 6
Telephoto zoom 27
Thumbnail playback 79
Time zone 20, 148, 150
Touch AF/AE 44
Touch shooting 41, 44, 55
Touch shutter 41

Tripod socket 5
TV 129
TV settings 158

U

USB cable 16, 133, 139
USB/audio/video output connector 5, 16, 129, 133, 139

V

Vibration reduction 153
Video mode 131, 158
ViewNX 2 132, 136
Voice memo 107
Volume 108, 128

W

WAV 171
Welcome screen 147
White balance 59
Wide-angle zoom 27

Nikon

No reproduction in any form of this manual, in whole or in part (except for brief quotation in critical articles or reviews), may be made without written authorization from NIKON CORPORATION.



NIKON CORPORATION

© 2010 Nikon Corporation

YP0102(11)
6MM84611-02