

Nikon

DIGITAL CAMERA

COOLPIX S700

User's Manual



En

Trademark Information

- Microsoft, Windows and Windows Vista are either registered trademarks or trademarks of Microsoft Corporation in the United States and/or other countries.
- Macintosh, Mac OS, and QuickTime are trademarks of Apple Inc.
- Adobe and Acrobat are registered trademarks of Adobe Systems Inc.
- The SD logo is a trademark of the SD Card Association.
- PictBridge is a trademark.
- ImageLink and the ImageLink print system logo are trademarks of Eastman Kodak Company.
- D-Lighting technology is provided by  Apical Limited.
- All other trade names mentioned in this manual or the other documentation provided with your Nikon product are trademarks or registered trademarks of their respective holders.

Introduction

First Steps



Basic Photography and Playback: Auto Mode



High-Sensitivity Shooting Mode



Shooting Suited for the Scene



More on Playback



Movies



Voice Recordings

Connecting to Televisions, Computers and Printers

MENU

Shooting, Playback and Setup Menus

Technical Notes

For Your Safety

To prevent damage to your Nikon product or injury to yourself or to others, read the following safety precautions in their entirety before using this equipment. Keep these safety instructions where all those who use the product will read them. The consequences that could result from failure to observe the precautions listed in this section are indicated by the following symbol:



This icon marks warnings, information that should be read before using this Nikon product, to prevent possible injury.

WARNINGS

Turn off in the Event of Malfunction

Should you notice smoke or an unusual smell coming from the camera or AC adapter, unplug the AC adapter and remove the battery immediately, taking care to avoid burns. Continued operation could result in injury. After removing or disconnecting the power source, take the equipment to a Nikon-authorized service representative for inspection.

Do not Disassemble

Touching the internal parts of the camera or AC adapter could result in injury. Repairs should be performed only by qualified technicians. Should the camera or AC adapter break open as the result of a fall or other accident, take the product to a Nikon-authorized service representative for inspection, after unplugging the product and/or removing the battery.

Do not use the Camera or AC Adapter in the Presence of Flammable Gas

Do not use electronic equipment in the presence of flammable gas, as this could result in explosion or fire.

Handle the Camera Strap with Care

Never place the strap around the neck of an infant or child.

Keep out of Reach of Children

Particular care should be taken to prevent infants from putting the battery or other small parts into their mouths.

⚠ Observe the following precautions when handling the battery

The battery may leak or explode if improperly handled. Observe the following precautions when handling the battery for use in this product:

- Before replacing the battery, turn the product off. If you are using the AC adapter, be sure it is unplugged.
- Only use a Rechargeable Li-ion Battery EN-EL10 (supplied). Charge the battery by inserting it in a Battery Charger MH-63 (supplied).
- When inserting the battery, do not attempt to insert it upside down or backwards.
- Do not short or disassemble the battery or attempt to remove or break the battery insulation or casing.
- Do not expose the battery to flame or to excessive heat.
- Do not immerse in or expose to water.
- Return the battery to the battery case for transportation. Do not transport or store with metal objects such as necklaces or hairpins.
- The battery is prone to leakage when fully discharged. To avoid damage to the product, be sure to remove the battery when no charge remains.
- Discontinue use immediately should you notice any change in the battery, such as discoloration or deformation.

⚠ Observe the following precautions when handling the battery charger

- If liquid from the damaged battery comes in contact with clothing or skin, rinse immediately with plenty of water.
- Keep dry. Failure to observe this precaution could result in fire or electric shock.
 - Dust on or near the metal parts of the plug should be removed with a dry cloth. Continued use could result in fire.
 - Do not handle the power cable or go near the battery charger during lightning storms. Failure to observe this precaution could result in electric shock.
 - Do not damage, modify, forcibly tug or bend the power cable, place it under heavy objects, or expose it to heat or flames. Should the insulation be damaged and the wires become exposed, take it to a Nikon-authorized service representative for inspection. Failure to observe these precautions could result in fire or electric shock.
 - Do not handle the plug or battery charger with wet hands. Failure to observe this precaution could result in electric shock.

For Your Safety

Use appropriate cables

When connecting cables to the input and output jacks, use only the cables provided or sold by Nikon for the purpose, to maintain compliance with product regulations.

Handle moving parts with care

Be careful that your fingers or other objects are not pinched by the lens cover or other moving parts.

CD-ROMs

The CD-ROMs supplied with this device should not be played back on audio CD equipment. Playing CD-ROMs on an audio CD player could cause hearing loss or damage the equipment.

Observe caution when using the flash

Using the flash close to your subject's eyes could cause temporary visual impairment. Particular care should be observed if photographing infants, when the flash should be no less than one meter (39 in.) from the subject.

Do not operate the flash with the flash window touching a person or object

Failure to observe this precaution could result in burns or fire.

Avoid contact with liquid crystal

Should the monitor break, care should be taken to avoid injury caused by broken glass and to prevent liquid crystal from the monitor touching the skin or entering the eyes or mouth.

Notices

Notice for Customers in the U.S.A.

Federal Communications Commission (FCC) Radio Frequency Interference Statement

This equipment has been tested and found to comply with the limits for a Class B digital device, pursuant to Part 15 of the FCC rules. These limits are designed to provide reasonable protection against harmful interference in a residential installation. This equipment generates, uses, and can radiate radio frequency energy and, if not installed and used in accordance with the instructions, may cause harmful interference to radio communications. However, there is no guarantee that interference will not occur in a particular installation. If this equipment does cause harmful interference to radio or television reception, which can be determined by turning the equipment off and on, the user is encouraged to try to correct the interference by one or more of the following measures:

- Reorient or relocate the receiving antenna.
- Increase the separation between the equipment and receiver.
- Connect the equipment into an outlet on a circuit different from that to which the receiver is connected.
- Consult the dealer or an experienced radio/television technician for help.



Nikon
COOLPIX S700

CAUTIONS

Modifications

The FCC requires the user to be notified that any changes or modifications made to this device that are not expressly approved by Nikon Corporation may void the user's authority to operate the equipment.

Interface Cables

Use the interface cables sold or provided by Nikon for your equipment. Using other interface cables may exceed the limits of Class B Part 15 of the FCC rules.

Notice for customers in the State of California

WARNING

Handling the cord on this product will expose you to lead, a chemical known to the State of California to cause birth defects or other reproductive harm.

Wash hands after handling.

Nikon Inc.,
1300 Walt Whitman Road
Melville, New York 11747-3064
USA
Tel: 631-547-4200

Notice for customers in Canada

CAUTION

This Class B digital apparatus complies with Canadian ICES-003.

ATTENTION

Cet appareil numérique de la classe B est conforme à la norme NMB-003 du Canada.

Symbol for Separate Collection in European Countries

This symbol indicates that this product is to be collected separately.



The following apply only to users in European countries:

This product is designated for separate collection at an appropriate collection point. Do not dispose of as household waste.

For more information, contact the retailer or the local authorities in charge of waste management.

Table of Contents









For Your Safety	ii
WARNINGS	ii
Notices	v
<hr/>	
Introduction	1
About This Manual	1
Information and Precautions	2
Parts of the Camera	4
The Camera Body	4
The Monitor	6
Basic Operations	8
The  (Shooting/Playback) Button	8
The MODE (Mode) Button	8
The Rotary Multi Selector	9
The MENU Button	10
Help Displays	11
Attaching the Camera Strap	11
<hr/>	
First Steps	12
Charging the Battery	12
Inserting the Battery	14
Removing the Battery	15
Turning On and Off the Camera	15
Setting Display Language, Date and Time	16
Inserting Memory Cards	18
Removing Memory Cards	19
<hr/>	
 Basic Photography and Playback: Auto Mode	20
Step 1 Turn the Camera On and Select  (Auto) Mode	20
Indicators Displayed in  (Auto) Mode	21
Step 2 Frame a Picture	22
Using the Zoom	23
Step 3 Focus and Shoot	24
Step 4 Viewing and Deleting Pictures	26
Viewing Pictures (Playback Mode)	26
Deleting Pictures	26
Using the Flash	28
Setting the Flash Mode	28
Taking Pictures with the Self-timer	30
Macro Mode	31
Exposure Compensation	32

Table of Contents

 High-Sensitivity Shooting Mode.....	33
Shooting in the High-Sensitivity Shooting Mode	33
<hr/>	
 Shooting Suited for the Scene.....	34
Shooting in the Scene Mode	34
Setting the Scene Mode.....	34
Features	35
Taking Pictures for a Panorama	40
<hr/>	
 More on Playback.....	43
Viewing Multiple Pictures: Thumbnail Playback	43
Viewing Multiple Pictures: Thumbnail Wheel Playback.....	44
Taking a Closer Look: Playback Zoom	45
Editing Pictures.....	46
Enhancing Brightness and Contrast: D-Lighting.....	47
Creating a Cropped Copy: Crop	48
 Resizing Pictures: Small Picture	49
Voice Memos: Recording and Playback	50
Recording Voice Memos	50
Playing Voice Memos	50
Deleting Voice Memos	50
Viewing Pictures by Date	51
Selecting a Date in Calendar Mode.....	51
Selecting a Date in List by Date Mode	52
Using Calendar Mode and List by Date Mode	53
Calendar and List by Date Menus.....	54
<hr/>	
 Movies	55
Recording Movies	55
The Movie Menu.....	56
Selecting Movie Options.....	56
Auto-focus Mode.....	58
Electronic VR.....	58
Time-Lapse Movies	59
Stop-Motion Movies	60
Movie Playback.....	61
Deleting Movie Files.....	61





























 Voice Recordings	62
Making Voice Recordings.....	62
Playing Voice Recordings.....	64
Deleting Sound Files.....	65
Copying Voice Recordings.....	66
<hr/>	
Connecting to Televisions, Computers and Printers	67
Connecting to a TV.....	67
Connecting to a Computer.....	68
Before Connecting the Camera.....	68
Transferring Pictures from a Camera to a Computer.....	69
Connecting to a Printer.....	72
Connecting the Camera and Printer.....	73
Printing Pictures One at a Time.....	74
Printing Multiple Pictures.....	75
Creating a DPOF Print Order: Print Set.....	78
Connecting to a ImageLink-compatible Printer.....	80
Removing the Dock Insert.....	80
<hr/>	
MENU Shooting, Playback and Setup Menus	81
Shooting Options: The Shooting Menu	81
Displaying the Shooting Menu and High-sensitivity Menu.....	81
 Image Mode.....	82
 White Balance.....	84
 Continuous.....	86
 ISO Sensitivity.....	88
 Color Options.....	89
 AF Area Mode.....	90
 Distortion Control.....	93
Restrictions on Camera Settings.....	93
Playback Options: The Playback Menu	95
Displaying the Playback Menu.....	95
 Slide Show.....	97
 Delete.....	98
 Protect.....	98
 Copy.....	99

Table of Contents

Basic Camera Setup: The Setup Menu	100
Displaying the Setup Menu.....	101
 Menus	101
 Welcome Screen	102
 Date.....	103
 Monitor Settings.....	106
 Date Imprint.....	107
 Vibration Reduction	109
 AF Assist	109
 Digital Zoom.....	110
 Sound Settings	110
 Auto Off.....	111
 Format Memory/  Format Card	111
 Language.....	112
 Video Mode	112
 Reset All	112
 Firmware Version	114
<hr/>	
Technical Notes	115
Optional Accessories	115
Approved Memory Cards	115
Image/Sound File and Folder Names	116
Caring for the Camera	117
Cleaning	119
Storage.....	119
Error Messages	120
Troubleshooting	124
Specifications	129
Supported Standards	132
Index	133

About This Manual

Thank you for your purchase of a Nikon COOLPIX S700 digital camera. This manual was written to help you enjoy shooting with your Nikon digital camera. Read this manual thoroughly before use, and keep it where all those who use the product will read it.

Symbols and Conventions

To make it easier to find the information you need, the following symbols and conventions are used:



This icon marks cautions, information that should be read before use, to prevent damage to the camera.



This icon marks tips, additional information that may be helpful when using the camera.



This icon marks notes, information that should be read before using the camera.



This icon indicates that more information is available elsewhere in this manual or in the *Quick Start Guide*.

Notations

- A Secure Digital (SD) memory card is referred to as a “memory card.”
- The setting at the time of purchase is referred to as the “default setting.”
- The names of menu items displayed in the camera monitor, and the names of buttons or messages displayed in the computer monitor are indicated with brackets ([]).

Screen Samples

In this manual, images are sometimes omitted from monitor display samples so that monitor indicators can be more clearly shown.

Illustrations and Screen Display

Illustrations and text displays shown in this manual may differ from actual display.



Memory Cards

Pictures shot with this camera can be stored in the camera's internal memory or on removable memory cards. If a memory card is inserted, all new pictures will be stored on the memory card and delete, playback and format operations will apply only to the pictures on the memory card. The memory card must be removed before the internal memory can be formatted or used to store, delete or view pictures.

Information and Precautions

Life-Long Learning

As part of Nikon's "Life-Long Learning" commitment to ongoing product support and education, continually updated information is available online at the following sites:

- For users in the U.S.A.: <http://www.nikonusa.com/>
- For users in Europe and Africa: <http://www.europe-nikon.com/support/>
- For users in Asia, Oceania, and the Middle East: <http://www.nikon-asia.com/>

Visit these sites to keep up-to-date with the latest product information, tips, answers to frequently asked questions (FAQs), and general advice on digital imaging and photography. Additional information may be available from the Nikon representative in your area. See the URL below for contact information:

<http://nikonimaging.com/>

Use Only Nikon Brand Electronic Accessories

Nikon COOLPIX cameras are designed to the highest standards and include complex electronic circuitry. Only Nikon brand electronic accessories (including battery chargers, batteries and AC adapters) certified by Nikon specifically for use with this Nikon digital camera are engineered and proven to operate within the operational and safety requirements of this electronic circuitry.

THE USE OF NON-NIKON ELECTRONIC ACCESSORIES COULD DAMAGE THE CAMERA AND MAY VOID YOUR NIKON WARRANTY.

For more information about Nikon brand accessories, contact a local authorized Nikon dealer.

Holographic seal: Identifies this device as an authentic Nikon product.



Rechargeable Li-ion
Battery EN-EL10

Before Shooting Important Pictures

Before shooting pictures on important occasions (such as at weddings or before taking the camera on a trip), take a test shot to ensure that the camera is functioning normally. Nikon will not be held liable for damages or lost profits that may result from product malfunction.

About the Manuals

- No part of the manuals included with this product may be reproduced, transmitted, transcribed, stored in a retrieval system, or translated into any language in any form, by any means, without Nikon's prior written permission.
- Nikon reserves the right to change the specifications of the hardware and software described in these manuals at any time and without prior notice.
- Nikon will not be held liable for any damages resulting from the use of this product.
- While every effort was made to ensure that the information in these manuals is accurate and complete, we would appreciate it were you to bring any errors or omissions to the attention of the Nikon representative in your area (address provided separately).

Notice Concerning Prohibition of Copying or Reproduction

Note that simply being in possession of material that was digitally copied or reproduced by means of a scanner, digital camera or other device may be punishable by law.

- **Items prohibited by law from being copied or reproduced**

Do not copy or reproduce paper money, coins, securities, government bonds or local government bonds, even if such copies or reproductions are stamped "Sample." The copying or reproduction of paper money, coins, or securities which are circulated in a foreign country is prohibited. Unless the prior permission of the government was obtained, the copying or reproduction of unused postage stamps or post cards issued by the government is prohibited. The copying or reproduction of stamps issued by the government and of certified documents stipulated by law is prohibited.

- **Cautions on certain copies and reproductions**

The government has issued cautions on copies or reproductions of securities issued by private companies (shares, bills, checks, gift certificates, etc.), commuter passes or coupon tickets, except when a minimum of necessary copies are to be provided for business use by a company. Also, do not copy or reproduce passports issued by the government, licenses issued by public agencies and private groups, ID cards and tickets, such as passes and meal coupons.

- **Comply with copyright notices**

The copying or reproduction of copyrighted creative works such as books, music, paintings, woodcut prints, maps, drawings, movies and photographs is governed by national and international copyright laws. Do not use this product for the purpose of making illegal copies or to infringe copyright laws.

Disposing of Data Storage Devices

Please note that deleting images or formatting data storage devices such as memory cards or built-in camera memory does not completely erase the original image data. Deleted files can sometimes be recovered from discarded storage devices using commercially available software, potentially resulting in the malicious use of personal image data. Ensuring the privacy of such data is the user's responsibility.

Before discarding a data storage device or transferring ownership to another person, erase all data using commercial deletion software, or format the device and then completely refill it with images containing no private information (for example, pictures of empty sky). Be sure to also replace any pictures selected for the welcome screen (📷 102). Care should be taken to avoid injury or damage to property when physically destroying data storage devices.

Parts of the Camera

The Camera Body

Introduction

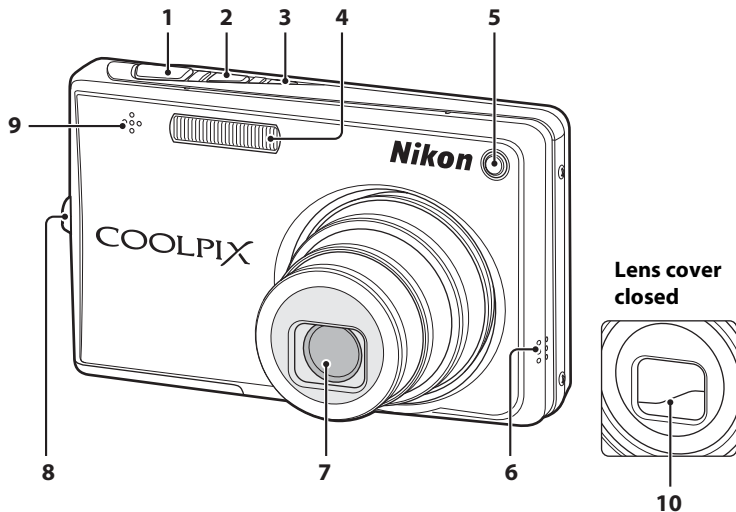

1	Shutter-release button.....	24	6	Speaker	50, 61, 64
2	Power switch.....	20	7	Lens.....	119, 129
3	Power-on lamp.....	20, 111	8	Eyelet for camera strap.....	11
4	Built-in flash	28	9	Built-in microphone.....	50, 55, 62
5	Self-timer lamp	30, 118	10	Lens cover	117
	AF-assist illuminator.....	25, 109, 118			

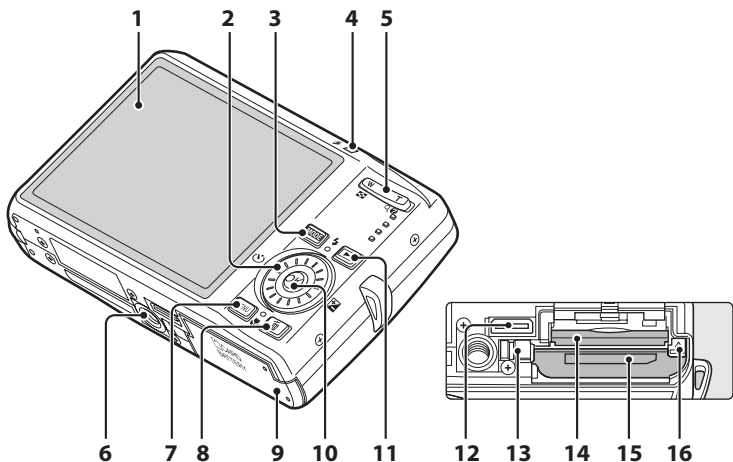

1	Monitor	6	7	MENU button.....	10, 34, 56, 81, 95
2	Rotary multi selector	9	8	(delete) button.....	26, 27, 50, 61, 65
3	MODE (mode) button.....	8	9	Battery-chamber/ memory card slot cover	14, 18
4	Indicator lamp	62	10	(apply selection) button	9
	Flash lamp.....	29	11	(shooting/playback) button	8, 26
5	Zoom buttons	23	12	Multi connector.....	67, 69, 73
	W (wide)	23	13	Power connector cover	115
	T (tele)	23	14	Memory card slot.....	18
	(thumbnail playback)	43	15	Battery-chamber	14
	(playback zoom)	45	16	Battery latch.....	14, 15
6	(help)	11			
6	Tripod socket				

The Monitor

The following indicators may appear in the monitor during shooting and playback (actual display varies with current camera settings).

Shooting

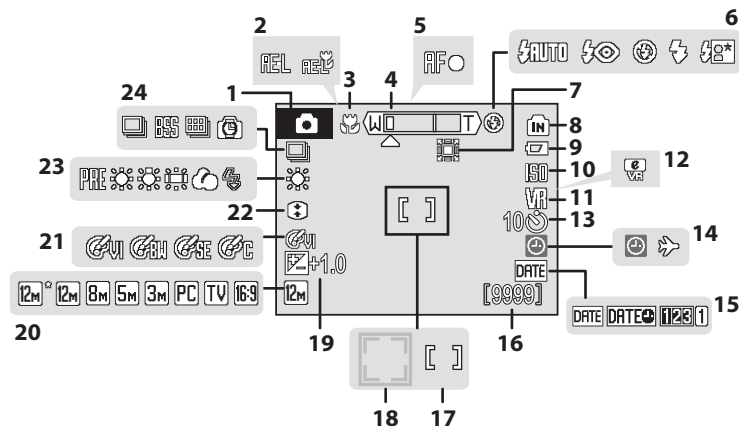

1	Shooting mode*	20, 33, 34, 55	14	"Date not set" indicator.....	120
2	Exposure lock.....	41	15	Time zone indicator	103
3	Macro mode.....	31	16	Date imprint.....	107
4	Zoom indicator.....	23, 31	17	Number of exposures remaining (still pictures)	20
5	Focus indicator	24	18	Movie length.....	55
6	Flash mode.....	28	19	Focus area	24, 90
7	Digital zoom interpolation indicator	23	20	Focus area (Face priority).....	24, 90
8	Internal memory indicator.....	21	21	Exposure compensation value	32
9	Battery level indicator.....	20	22	Image mode	82
10	ISO sensitivity.....	29, 88	23	Color options	89
11	Vibration reduction icon (still pictures).....	109	24	Distortion control.....	93
12	Electronic VR icon (movies).....	58		White balance mode.....	84
13	Self-timer indicator.....	30		Continuous shooting mode.....	86

* Differs according to the current shooting mode. Refer to the sections on each mode for details.

Playback

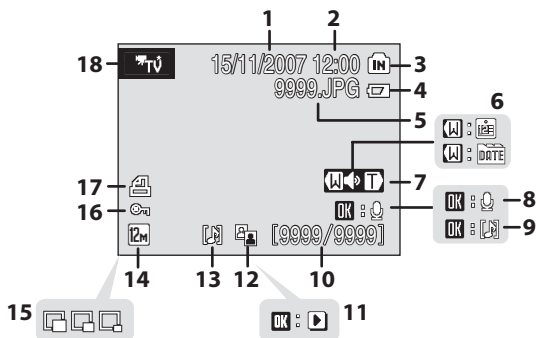





1	Date of recording.....	16	10	Current frame number/ total number of frames.....	26
2	Time of recording.....	16		Movie length	61
3	Internal memory indicator.....	26	11	Movie playback indicator	61
4	Battery level indicator	20	12	D-Lighting icon.....	47
5	File number and type	116	13	Voice memo icon	50
6	Calendar guide/ list by date guide.....	51, 52	14	Image mode	82
7	Volume indicator	50, 61	15	Small picture.....	49
8	Voice memo recording guide.....	50	16	Protect icon.....	98
9	Voice memo playback guide.....	50	17	Print-order icon.....	78
			18	Movie indicator*	61

* Differs according to the selected movie option.

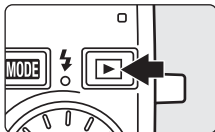
Basic Operations

The (Shooting/Playback) Button



Press  once in shooting mode to enter playback mode; press again to switch back to shooting mode. Pressing the shutter-release button halfway in playback mode ( 26) will also activate shooting mode. If the camera is turned off, hold down  to turn the camera on in playback mode ( 26).

The **MODE** (Mode) Button

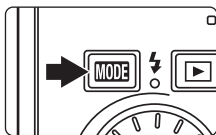

Press **MODE** during shooting to display the shooting-mode selection menu, or during playback to display the playback-mode selection menu. Use the rotary multi-selector ( 9) to choose the desired mode.

- Press  to switch between the mode-selection menus for shooting mode and playback mode.

Shooting-mode Selection Menu

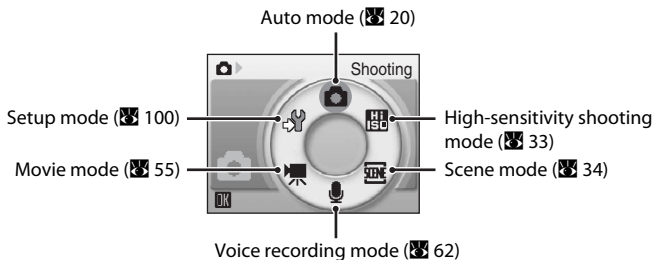

Playback-mode Selection Menu

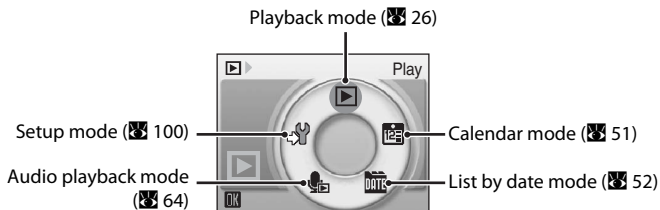

The Rotary Multi Selector

This section describes standard uses of the rotary multi selector to select modes, select menu options and to apply selection.

For Shooting

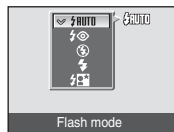
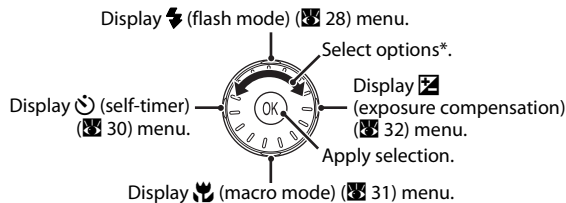

* Items can also be selected by pressing the rotary multi selector up or down.

For Playback

Select previous picture*.

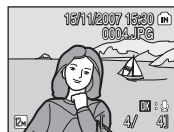
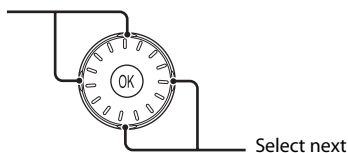

* Pictures can also be chosen by rotating the rotary multi selector.

For the Menu Screen

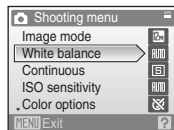
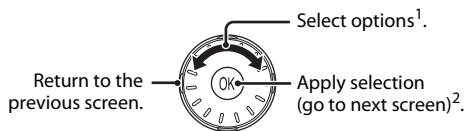

¹ Items can also be selected by pressing the rotary multi selector up or down. Pressing right or left in shooting/playback-mode selection menu (F 8) or icons menu (F 101) will choose the items.

² Pressing right in text menus (F 101) will go to the next screen.

Notes on the Rotary Multi Selector

- In many cases, you can choose how to use the rotary multi selector to perform an operation. For example, rotating the selector clockwise and pressing the selector right may produce the same results. Since the selector can be used in various ways, concrete descriptions such as "Press the rotary multi selector " are included only in cases where necessary.
- In the manual, the button indicating up, down, left and right of the rotary multi selector is shown as , , and .

The MENU Button

Press **MENU** to display the menu for the selected mode. Use the rotary multi selector to navigate the menus (▶ 9).



Displayed when there are one or more menu items to follow

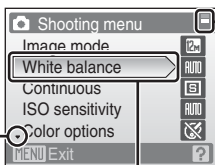

Displayed when the menu contains two or more pages

The selected option

Displayed when there are more previous menu items

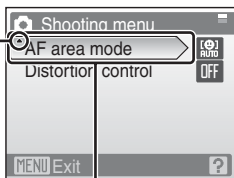

Press the rotary multi selector ▶ or **OK** to proceed to the next set of options.

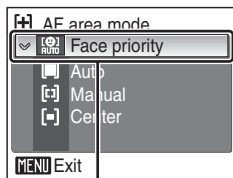

Press the rotary multi selector ▶ or **OK** to apply selection.

Help Displays

Press **T** (?) when ? is displayed at the lower right of the menu screen to view a description of the currently selected menu option.

To return to the original menu, press **T** (?) again.

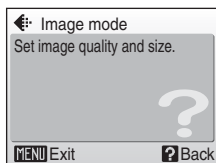
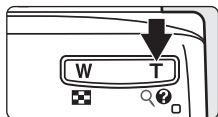

Attaching the Camera Strap

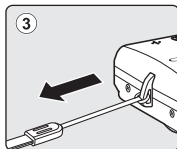
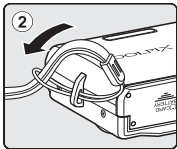
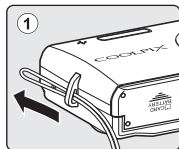

Charging the Battery

The camera uses a Rechargeable Li-ion Battery EN-EL10 (supplied).

Charge the battery with the Battery Charger MH-63 (supplied) before first use or when the battery is running low.

1 Connect the power cable.

Connect the power cable to the battery charger ① and insert the wall plug into a power outlet ②. The CHARGE lamp will light to show that the charger is on ③.

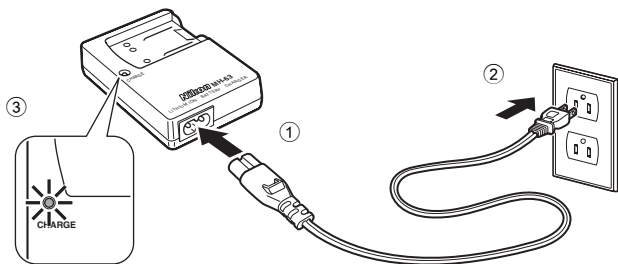

2 Charge the battery.

Insert the battery into the battery charger ①.

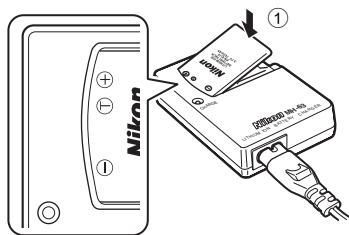

CHARGE lamp starts blinking when battery is inserted ②. Charging is complete when lamp stops blinking ③.

About 100 minutes are required to charge a fully depleted battery.

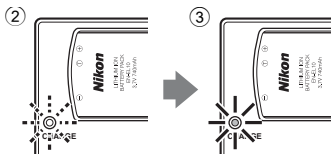

CHARGE lamp	Description
Blinks	Battery charging.
On	Battery fully charged.
Flickers	<ul style="list-style-type: none"> Use the charger at an ambient temperature range of 5 to 35 °C (41 to 95 °F) to charge the battery. The battery is faulty. Unplug the charger immediately and stop charging the battery. Bring the battery and charger to a Nikon-authorized service representative for inspection.

3 Unplug the charger.

Remove the battery and unplug the charger.

Note on the Battery Charger

- Be sure to read and follow the warnings for the battery charger on pages iii and iv before using the battery charger.
- The supplied battery charger is for use only with a Rechargeable Li-ion Battery EN-EL10. Do not use with incompatible batteries.

Note on the Battery

Be sure to read and follow the warnings for the battery on page iii and the section, "The Battery" (☒ 118), before using the battery.

Note on AC power supply

- To power the camera continuously for extended periods, use the AC Adapter EH-62D (available separately from Nikon). Do not, under any circumstances, use another make or model of AC adapter. Failure to observe this precaution could result in overheating or in damage to the camera.
- The AC adapter cannot be used when the camera is mounted on a tripod.
- The AC adapter and the supplied audio video/USB cable cannot be used at the same time.

Inserting the Battery

Insert a Rechargeable Li-ion Battery EN-EL10 (supplied) that has been fully charged, using the Battery Charger MH-63 (supplied), into your camera.

- 1 Open the battery-chamber/memory card slot cover.

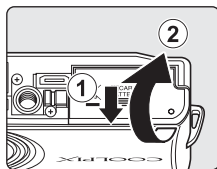

- 2 Insert the battery.

Confirm that the positive (+) and negative (-) terminals are oriented correctly as described on the label at the entrance of the battery chamber, and insert the battery.

Use the battery to push the orange battery latch up ① as the battery is inserted ②. The battery latch will spring back into place when the battery is fully inserted.

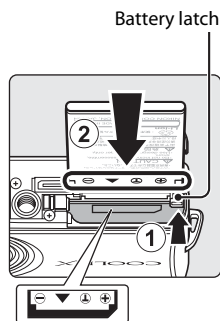

✓ Inserting the Battery

Inserting the battery upside down or backwards could damage the camera. Be sure to check the battery is in the correct orientation.

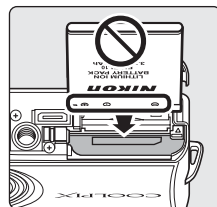

- 3 Close the battery-chamber/memory card slot cover.

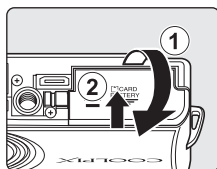

Removing the Battery

Turn the camera off and confirm that the power-on lamp is off before removing the battery.

To eject the battery, open the battery-chamber/memory card slot cover and slide the battery latch in the direction shown ①. The battery can then be removed by hand ②.

- Note that the battery may become hot during use; observe due caution when removing the battery.

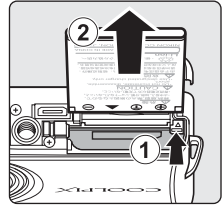

Turning On and Off the Camera

To turn on the camera, press the power switch. The power-on lamp (green) will light and the monitor will turn on. To turn off the camera, press the power switch again.

If the camera is turned off, hold down  to turn the camera on in playback mode.

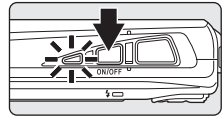

Setting Display Language, Date and Time

A language-selection dialog is displayed the first time the camera is turned on.

1 Press the power switch to turn on the camera.

The power-on lamp will light and the monitor will turn on.

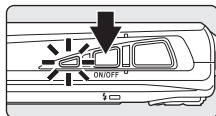

2 Use the rotary multi selector to choose the desired language and press **OK**.

For information on using the rotary multi selector, see "The Rotary Multi Selector" (9).



3 Choose [Yes] and press **OK**.

If [No] is selected, the date and time will not be set.

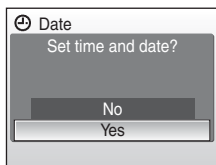

4 Press **OK**.

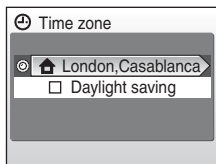

Daylight Saving Time

If daylight saving time is in effect, turn on [Daylight saving] in the [Time zone] menu and set the date.

- 1 Before pressing **OK**, press the rotary multi selector ▼ to choose [Daylight saving].
- 2 Press **OK** to enable daylight saving time (✓). Pressing **OK** toggles the daylight saving time option on and off.
- 3 Press the rotary multi selector ▲, and then press **OK** to proceed to step 5.

When daylight saving time ends, turn [Daylight saving] off from the [Date] menu (9) in the setup menu. The camera's clock is automatically set back one hour.

- 5** Select your home time zone (🌐 105) and press **OK**.

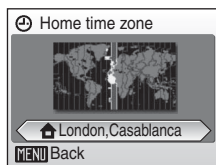

- 6** Edit the date.

- Rotate the rotary multi selector, or press **▲** or **▼**, to edit the highlighted item.
- Press **▶** to move the highlight in the following order. [D] (day) → [M] (month) → [Y] (year) → hour → minute → [DMY] (the order in which the day, month, and year are displayed)
- Press **◀** to return to the previous item.

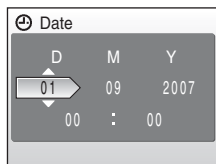

- 7** Choose the order in which the day, month and year are displayed and press **OK** or press **▶**.

The settings are applied and monitor display exits to shooting mode.

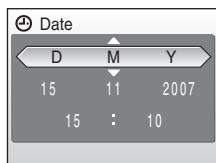

Changing the date and time

To change the current date and time, in the setup menu (🌐 100) go into [Date] (🌐 103), choose [Date] and follow the instructions starting from step 6.

Inserting Memory Cards

Pictures are stored in the camera's internal memory (approx. 52 MB) or on removable Secure Digital (SD) memory cards (available separately) (115).

If a memory card is inserted in the camera, pictures are automatically stored on the memory card and pictures recorded to the memory card can be played back, deleted or transferred. Remove the memory card to store pictures in the internal memory, or play back, delete or transfer pictures from the internal memory.

First Steps

- 1 Turn the camera off and open the battery-chamber/memory card slot cover.

If the power-on lamp is lit, press the power switch to turn off the camera.

Make sure that the camera is off (power-on lamp is off) before inserting or removing the memory card.

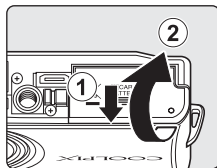

- 2 Insert the memory card.

Slide the memory card in correctly until it clicks into place.

Close the battery-chamber/memory card slot cover.

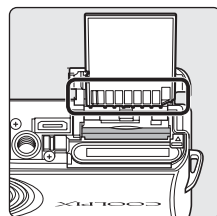

Inserting Memory Cards

Inserting the memory card upside down or backwards could damage the camera or the memory card. Make sure that the memory card is correctly oriented.

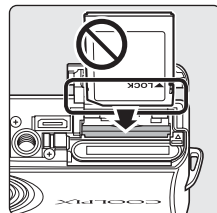

Removing Memory Cards

Before removing memory cards, **turn the camera off** and confirm that the power-on lamp is off. Open the battery-chamber/memory card slot cover and press the card in ① to partially eject the card ②. The card can then be removed by hand.

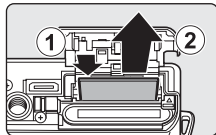

Formatting Memory Cards

If the message at right is displayed, the memory card must be formatted before use (☒ 111). Note that **formatting permanently deletes all pictures** and other data on the memory card. Be sure to make copies of any pictures you wish to keep before formatting the memory card.

Use the rotary multi selector to choose [Yes] and press **OK**. A confirmation dialog is displayed. To start formatting, choose [Format] and press **OK**.

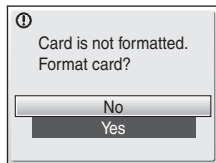

• **Do not turn the camera off or open the battery-chamber/memory card slot cover until formatting is complete.**

• The first time you insert the memory cards used in other devices into the COOLPIX S700, be sure to format them with this camera (☒ 111).

The Write Protect Switch

SD memory cards are equipped with a write protect switch. Pictures cannot be recorded or deleted and the memory card cannot be formatted when this switch is in the "lock" position. Unlock by sliding the switch to the "write" position.

Write protect switch

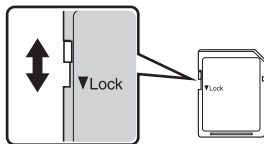

Memory Cards

- Use only Secure Digital memory cards.
- Do not perform the following during formatting, while data is being written to or deleted from the memory card, or during data transfer to a computer. Failure to observe this precaution could result in the loss of data or in damage to the camera or memory card:
 - Take out the battery or memory card
 - Turn off the camera
 - Disconnect the AC adapter
- Do not format the memory card using a computer.
- Do not disassemble or modify.
- Do not drop, bend, or expose to water or strong physical shocks.
- Do not touch the metal terminals with your fingers or metal objects.
- Do not affix labels or stickers to the memory card.
- Do not leave in direct sunlight, closed vehicles or areas exposed to high temperatures.
- Do not expose to humidity, dust, or to corrosive gases.

Step 1 Turn the Camera On and Select (Auto) Mode

This section describes how to shoot in  (auto) mode, an automatic, “point-and-shoot” mode recommended for first-time users of digital cameras.

1 Press the power switch to turn on the camera.

The power-on lamp will light up, the lens will open and the monitor will turn on.

Proceed to step 4 when  is displayed.

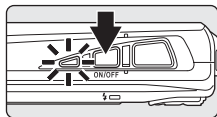

2 Press **MODE**.

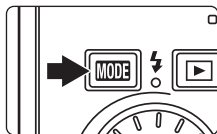



3 Use the rotary multi selector to choose and press **OK**.

The camera enters  (auto) mode.



4 Check the battery level and number of exposures remaining.

Battery Level

Monitor	Description
NO INDICATOR	Battery fully charged.
	Battery low; prepare to charge or replace the battery.
 Warning! Battery exhausted.	Cannot shoot pictures. Recharge or replace with a fully charged battery.

Battery level indicator

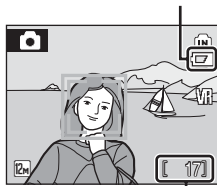



Number of exposures remaining

Number of Exposures Remaining

The number of pictures that can be stored depends on the capacity of the internal memory or memory card and image mode setting ( 82).

Indicators Displayed in (Auto) Mode

Shooting mode
 displayed in  (auto) mode.

Internal memory indicator
 Pictures will be recorded to internal memory. When memory card is inserted,  is not displayed and pictures will be recorded to memory card.

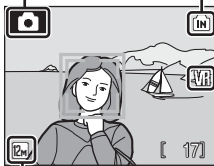











Image mode
 Display image size and quality set in the image mode menu. The default setting is  Normal (4,000 × 3,000).



Vibration reduction icon
 Vibration reduction will be adjusted.

Available Functions in (Auto) Mode

In  (auto) mode, macro mode ( 31) and exposure compensation ( 32) can be applied and pictures can be shot using the flash mode ( 28) and self-timer ( 30). Pressing **MENU** in  (auto) mode allows you to specify settings for all shooting menu items ( 81).

Vibration Reduction

[Vibration reduction] ( 109), when [On] (default setting) is selected, can be applied to effectively reduce blur, caused by slight hand movement known as camera shake, that commonly occurs when shooting with zoom applied or at slow shutter speeds.

Turn vibration reduction ( 109) [Off] when using a tripod to stabilize the camera during shooting. To reduce the effects of camera shake when recording movies, enable [Electronic VR] ( 58) from the movie menu ( 56).

Auto Power-Off in Shooting Mode (Standby Mode)

The monitor will dim to reduce the drain on the battery if no operations are performed for about five seconds. The monitor will brighten when camera controls are used. At default settings, the monitor will turn off altogether if no operations are performed for about a minute during shooting and playback. The camera will turn off automatically if no operations are performed for another three minutes ( 111).

Step 2 Frame a Picture

1 Ready the camera.

Hold the camera steadily in both hands, keeping your fingers and other objects away from the lens, flash and self-timer lamp.

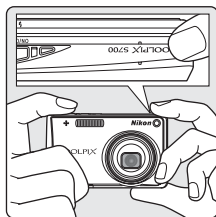

When taking pictures in “tall” orientation, turn the camera clockwise so that the built-in flash is above the lens.

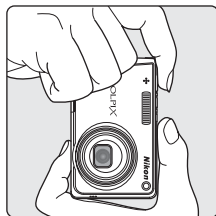

2 Frame the picture.

When the camera recognizes a face looking toward the camera, that face will be framed by a yellow double border (by default). If more than one face is recognized, the face closest to the camera will be framed by a double border and the others by single borders.

Focus area will not appear when shooting pictures of subjects other than people, or framing a subject with which no face is recognized.

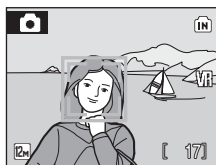

Using the Zoom

Use the zoom buttons to activate optical zoom. Press **W** (📷) to zoom out, increasing the area visible in the frame, or **T** (🔍) to zoom in so that the subject fills a larger area of the frame.

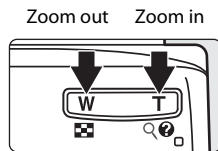

When the camera is zoomed in to the maximum magnification (3x), holding down **T** (🔍) triggers digital zoom. The subject is magnified up to 4x, for a total magnification of 12x.

Focus will be on the center of the screen when digital zoom is in effect.

A monitor indicator shows the current zoom ratio.

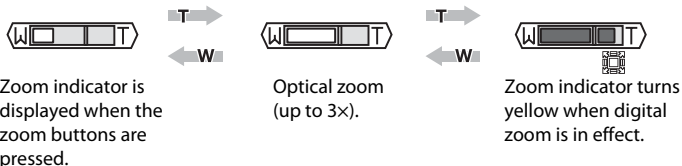

✓ Digital Zoom and image quality

If possible, digital zoom will create a picture by cropping the area visible in the monitor to the current image mode (📷 82), increasing magnification without affecting quality.

If the crop would be smaller than the image size for the current image mode, additional pixels are added through a process known as interpolation, creating a slightly “grainy” image.

The amount of zoom available before interpolation is used depends on the option currently selected for image mode, as shown in the following table. The camera pauses temporarily in its zooming operation when it reaches the maximum zoom ratio possible before interpolation is used. 📷 is displayed when interpolation is in effect.

Maximum zoom ratio without interpolation

Image mode	Zoom rate	Image mode	Zoom rate
📷, 📷, 📷	3x (up to the maximum optical zoom ratio)	3M	5.4x (digital zoom up to 1.8x)
8M	3.6x (digital zoom up to 1.2x)	PC	11.4x (digital zoom up to 3.8x)
5M	4.2x (digital zoom up to 1.4x)	TV	12x (digital zoom up to 4x)

Digital zoom can be turned off (📷 110).

Step 3 Focus and Shoot

1 Press the shutter-release button halfway.

When a face looking toward the camera is recognized:
Camera will focus on the face surrounded by a double border.

- Once focus has been locked the double border will glow green.
- When the camera is unable to focus, the double border will blink. Press the shutter-release button halfway and try focusing again.

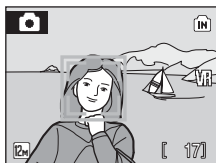
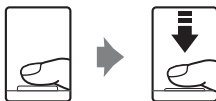

When shooting pictures of subjects other than people or framing a subject with which no face is recognized:

Camera automatically selects the focus area (one of nine) containing the subject closest to the camera.

- When the subject is in focus, the active focus area and focus indicator (AF ●) glow green.
- When the camera is unable to focus, the focus area and focus indicator will blink red. Recompose the picture and press the shutter-release button halfway to try focusing again.

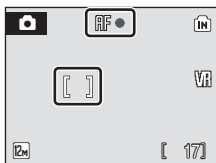
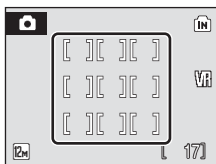

The focus area is not displayed when digital zoom is in effect, and focus will be in the center of the screen.



See [AF area mode] (90) and "Shooting with Face Priority" (92) for more information about Face Priority.

2 Press the shutter-release button the rest of the way down.

The picture will be recorded to the memory card or internal memory.



During Recording

While pictures are being recorded, the  (wait) icon will be displayed and either the  icon or the  icon (when a memory card is inserted in the camera) will blink. Do not turn the camera off, open the battery-chamber/memory card slot cover, or remove or disconnect the power source while these icons are displayed. Cutting power or removing the memory card in these circumstances could result in loss of data or in damage to the camera or card.

Autofocus

Autofocus may not perform as expected in the following situations. In some rare cases, the subject may not be in focus despite the fact that the active focus area and the focus indicator glow green:

- Subject is very dark
- Objects of sharply differing brightness are included in the scene (e.g. the sun is behind the subject and is in deep shadow)
- No contrast between the subject and surroundings (e.g. when the subject is standing in front of a white wall, wearing a white shirt)
- Several objects are at different distances from the camera (e.g. the subject is inside a cage)
- Subject is moving rapidly

In the situations noted above, try pressing the shutter-release button halfway to refocus several times, or focus on another subject and use focus lock ( 91). When using focus lock, be sure that the distance between the camera and the subject with which focus was locked is the same as that for the actual subject.

Shutter-release Button

The camera features a two-stage shutter-release button. To set focus and exposure, press the shutter-release button halfway, stopping when you feel resistance. Focus and exposure lock while the shutter-release button is held in this position. To release the shutter and shoot, press the shutter-release button the rest of the way down. Do not use force when pressing the shutter-release button, as this may result in camera shake and blurred pictures.



Press the shutter-release button halfway to set focus and exposure.



Press the shutter-release button the rest of the way down to shoot.

AF-assist Illuminator and Flash

If the subject is poorly lit, the AF-assist illuminator may light by pressing the shutter-release button halfway, or the flash may fire by pressing the shutter-release button all the way down. The illuminator has a range of about 1.9 m (6.2 ft.) at the maximum wide-angle position and 1.1 m (3.6 ft.) at the maximum telescopic position. The AF-assist illuminator can be set to [Off] manually ( 109), although in this case the camera may not focus when lighting is poor.

Step 4 Viewing and Deleting Pictures

Viewing Pictures (Playback Mode)



Press .

The last picture shot will be displayed in full-frame playback mode.

Use the rotary multi selector , ,  or  to view additional pictures.

Pictures may be displayed briefly at low resolution while being read from the memory card or internal memory.

Press  or the shutter-release button to switch to shooting mode.

When  is displayed, pictures stored in the internal memory will be displayed. When memory card is inserted,  is not displayed and pictures stored on the memory card will be displayed.

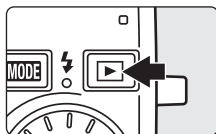

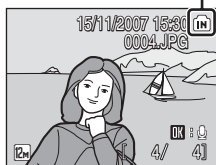

Internal memory indicator

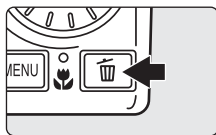

Deleting Pictures

- 1 Press  to delete the picture currently displayed in the monitor.







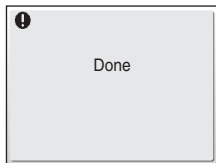
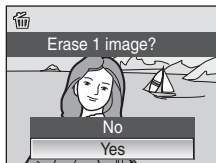

- 2 Use the rotary multi selector to select [Yes] and press .

To exit without deleting the picture, select [No] and press .





Playback Mode

The following options are available in full-frame playback mode.

Option	Use	Description	
Playback zoom	T (Q)	Enlarge picture display. Press T (Q) to enlarge up to 10x, and W (R) to reduce. Press OK to return to full-frame playback mode.	45
View thumbnails	W (R)	Press W (R) to display 4, 9, 16 picture thumbnails.	43
Thumbnail wheel playback		Rotate the rotary multi selector to change to thumbnail wheel playback mode.	44
Record/play voice memo	OK	Press OK to record or play back voice memos up to 20 seconds in length.	50
Switch to shooting mode	  	Press  or the shutter-release button to switch to the shooting mode selected in the shooting-mode selection menu.	26

Pressing to Turn On the Camera

When the camera is off, holding down  will turn the camera on in playback mode. If the camera is turned off in voice recording mode ( 62) or audio playback mode ( 64), the camera will be turned on in audio playback mode the next time.

Viewing Pictures

- Pictures stored in the internal memory can only be viewed if no memory card is inserted.
- When pictures in which a face was detected during shooting are played back, the pictures will be automatically rotated for playback display, according to the orientation of the face detected.

Deleting the Last Picture Shot

In shooting mode, press  to delete the last picture shot.

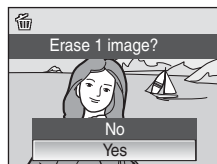

Using the Flash

The flash has a range of about 0.3-4.8 m (1-15 ft. 8.9 in.) when the camera is zoomed out all the way. With maximum optical zoom applied, the range is about 0.3-2.4 m (1-7 ft. 10.5 in.) (when [ISO sensitivity] is set to [Auto]). The following flash modes are available.

Auto (default setting for (auto) mode)

Flash fires automatically when lighting is poor.

Auto with red-eye reduction

Reduces “red-eye” in portraits ( 29).

Off

Flash will not fire even when lighting is poor.

Fill flash

Flash fires when a picture is shot. Use to “fill-in” (illuminate) shadows and backlit subjects.

Slow sync

 **Auto** (auto) is combined with slow shutter speed.

Flash illuminates main subject; slow shutter speeds are used to capture background at night or under dim light.

Setting the Flash Mode

1 Press (flash mode).

The flash menu is displayed.

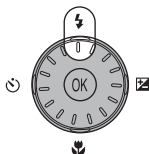

2 Use the rotary multi selector to choose the desired flash mode and press .

The icon for the selected flash mode is displayed at the top of the monitor.

When  **Auto** (auto) is applied,  is only displayed for five seconds.

If a setting is not applied by pressing  within a few seconds, the selection will be cancelled.

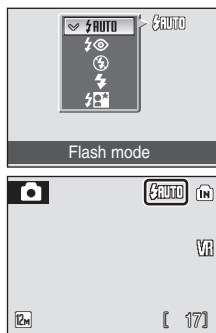

✓ Shooting When Lighting Is Poor and the Flash Is Disabled (📷)

- Use of a tripod is recommended to stabilize the camera during shooting and avoid the effects of camera shake. Turn vibration reduction (📷 109) [Off] when using a tripod.
- The 📷 symbol is displayed when the camera automatically increases sensitivity to minimize blur caused by slow shutter speed. Pictures shot when 📷 is displayed may be slightly mottled.

✓ Note on Using the Flash

When using the flash at a wide-angle zoom position, reflections from dust particles in the air may appear as bright spots in pictures. To reduce these reflections, set the flash to 📷 (Off) or zoom in on the subject.

🔪 The Flash Lamp

The flash lamp indicates flash status when the shutter-release button is pressed halfway.

- **On:** Flash will fire when picture is shot.
- **Blinks:** Flash charging. Wait a few seconds and try again.
- **Off:** Flash will not fire when picture is shot.

When pictures are shot using the flash and a low battery, the monitor display will turn off and the flash lamp will blink until the flash is fully charged.

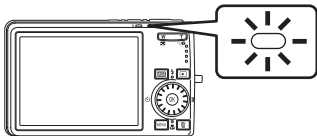

🔪 The Flash Mode Setting

The default setting is 📷 (auto) (except for some modes in scene mode).

When flash mode is applied in a scene mode, the setting is only enabled until another shooting mode is selected or the camera is turned off. Switching to another shooting mode or turning the camera off enables the default flash setting for all modes.

🔪 Red-eye Reduction

This camera uses advanced red-eye reduction ("In-Camera Red-Eye Fix"). The flash fires repeatedly at low intensity before the main flash, reducing red-eye. The camera then analyzes the picture; if red-eye is detected, the affected area will be processed to further reduce red-eye before the picture is saved. Note that because there is a slight lag between the shutter-release button being pressed and the picture being shot, this mode is not recommended when a quick shutter response is required. The time before the next picture can be shot also increases slightly. Advanced red-eye reduction may not produce the desired results in all situations. In extremely rare instances, areas not subject to red-eye may be affected by advanced red-eye reduction processing; in these cases, choose another mode and try again.

Taking Pictures with the Self-timer

The camera is equipped with a ten-second and three-second timer for self-portraits. When using the self-timer, use of a tripod is recommended. Turn vibration reduction (📷 109) [Off] when using a tripod.

1 Press (self-timer).

The self-timer menu is displayed.

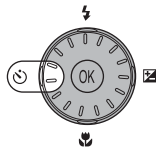

2 Use the rotary multi selector to choose [10s] or [3s] and press .

[10s] (ten seconds): Suited for important occasions (such as weddings)

[3s] (three seconds): Suited for preventing camera shake
The mode selected for self-timer is displayed.

If a setting is not applied by pressing  within a few seconds, the selection will be cancelled.

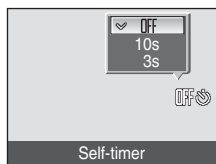

3 Frame the picture and press the shutter-release button halfway.

Focus and exposure will be set.

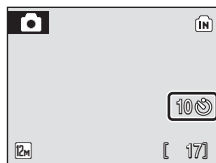

4 Press the shutter-release button the rest of the way down.

The self-timer starts and the self-timer lamp will blink. The lamp stops blinking one second before the photograph is shot and remains lit until the shutter is released.

The number of seconds remaining before the shutter is released is displayed in the monitor.

When the shutter is released, the self-timer turns off.

To stop the timer before a picture is shot, press the shutter-release button again.

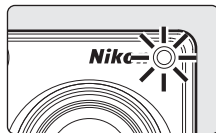
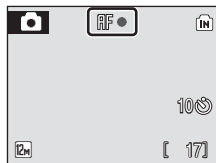

Macro Mode

Macro mode is used for taking pictures of objects as close as 6 cm (2.4 in.). Note that the flash may be unable to light entire subject at distances of less than 30 cm (11.8 in.).

1 Press (macro mode).

The macro menu is displayed.

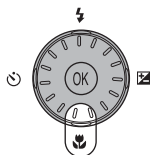

2 Use the rotary multi selector to choose [ON] and press .

The macro mode icon () is displayed.

The monitor will return to the normal display for the current mode if the setting is not applied by pressing  within a few seconds.

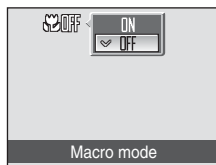

3 Press **T** () or **W** () to frame the picture.

The camera can focus at a distance of 6 cm (2.4 in.) at the zoom position at which  glows green (wide zoom position).

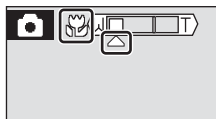

Macro Mode

In macro mode, the camera focuses continuously, even when the shutter-release button is not pressed halfway to lock focus.

The Macro Mode Setting

When macro mode is applied in a scene mode, the setting is only enabled until another shooting mode is selected or the camera is turned off. Switching to another shooting mode or turning the camera off enables the default macro setting for all modes.

Exposure Compensation

Exposure compensation is used to alter exposure from the value suggested by the camera to make pictures brighter or darker.

1 Press (exposure compensation).

The exposure compensation menu is displayed.

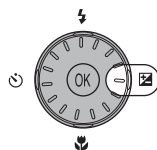

2 Use the rotary multi selector to adjust exposure.

- When the picture is too dark: adjust the exposure compensation to "+" side.
- When the picture is too bright: adjust the exposure compensation to "-" side.
- Exposure compensation can be set to values between -2.0 and +2.0 EV.
- If a setting is not applied by pressing  within a few seconds, the selection will be cancelled.

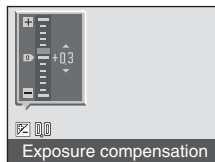

3 The setting is applied.

- The value is displayed with the  icon in the monitor.



Exposure Compensation Value

When exposure compensation is adjusted in a scene mode, the setting is only enabled until another shooting mode is selected or the camera is turned off. Switching to another shooting mode or turning the camera off returns exposure compensation to [0.0].

Using Exposure Compensation

The camera tends to lower exposure when the frame is dominated by brightly lit objects and to increase exposure when the frame is mostly dark. *Positive* compensation may therefore be required to capture the brilliancy of very bright objects that fill the frame (for example, sunlit expanses of water, sand, or snow) or when the background is much brighter than the main subject. *Negative* compensation may be called for when large areas of the frame contain very dark objects (for example, a swath of dark green leaves) or when the background is much darker than the main subject.

Shooting in the High-Sensitivity Shooting Mode

In high-sensitivity shooting mode, sensitivity is increased when shooting under low lighting, to reduce blurring caused by camera shake or subject movement, allowing you to capture the atmosphere of the scene. ISO sensitivity will be automatically increased to a maximum of 1600, depending upon the brightness of the subject.

- 1 Enter high-sensitivity shooting mode by pressing **MODE** in shooting mode, selecting **HI ISO** (use the rotary multi selector), and then pressing **OK**.

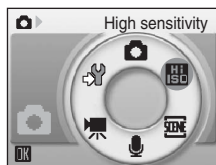
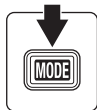

- 2 Frame the subject and shoot.

When a face looking toward the camera is recognized, the camera will focus on the face surrounded by a double border.

When shooting pictures of subjects other than people or framing a subject with which no face is recognized, the camera automatically selects the focus area (one of nine) containing the subject closest to the camera.

See [AF area mode] (P 90) and "Shooting with Face Priority" (P 92) for more information about face priority.

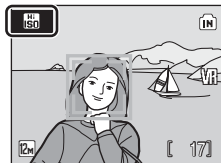

Notes on High-Sensitivity Shooting Mode

- This mode reduces effects of camera shake even for shooting under low lighting; however, when shooting without the flash, use of a tripod is recommended. Turn vibration reduction (P 109) [Off] when using a tripod.
- Pictures shot in this mode may become somewhat grainy.
- Focus may not be precisely fixed in extremely dark places.

Options Available in High-Sensitivity Shooting Mode

- Settings can be changed for flash mode (P 28), self-timer (P 30), macro mode (P 31) and exposure compensation (P 32).
- Pressing **MENU** in high-sensitivity shooting mode allows you to change the settings for all options in shooting menu (except ISO Sensitivity) (P 81).

Shooting in the Scene Mode

Camera settings are automatically optimized for the selected subject type. The following scene modes are available.

Portrait	Party/indoor	Night landscape	Copy
Landscape	Beach/snow	Close up	Backlight
Sports	Sunset	Museum	Panorama assist
Night portrait	Dusk/dawn	Fireworks show	

Setting the Scene Mode

- 1 Enter scene mode by pressing **MODE** in shooting mode, selecting (use the rotary multi selector), and then pressing **OK**.

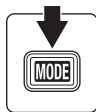

- 2 Press **MENU** to display the scene menu screen, choose the desired scene and press **OK**.

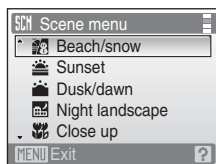
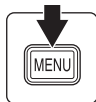

- 3 Frame the subject and shoot.

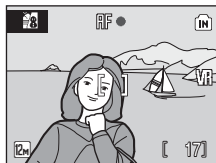
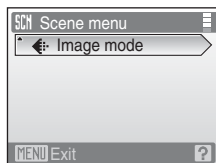

Image Mode

[Image mode] (82) can be set in the scene menu. Changes made to these settings apply to all shooting modes.



Features

Portrait

Use this mode for portraits in which the main subject stands out clearly. Portrait subjects exhibit smooth, natural-looking skin tones.

- The camera detects and focuses on a face looking toward the camera (Shooting with Face Priority → 92).
- If the camera detects multiple faces, the camera focuses on the face closest to the camera.
- If no face is recognized, the camera will focus on the subject in the center focus area.
- Digital zoom is not available.



* Other settings can be selected.

Landscape

Use this mode for vivid landscapes and cityscapes.

- Camera focuses at infinity. The focus indicator (24) always glows green when the shutter-release button is pressed halfway. Note, however, that objects in the foreground may not always be in focus.



* Other settings can be selected.

Sports

Use this mode for dynamic action shots that freeze the action in a single shot and record motion in a series of pictures.

- While the shutter-release button is pressed halfway, the camera focuses continuously until focus is acquired and locked.
- While the shutter-release button is held down, pictures are shot at a rate of about 1.0 frames per second (fps) when image mode is set to [Normal (4000)]. This rate is maintained for up to 5 pictures.
- The maximum frame rate with continuous shooting may vary depending upon the current image mode setting and the memory card used.



* Other settings can be selected.

Icons Used for Descriptions

The following icons are used for descriptions in this section: ⚡, flash mode (28); ⌚, self-timer (30); 🔍, macro mode (31); ⓧ, exposure compensation (32); Ⓜ, AF-assist illumination (109).

Scene Mode Settings

Adjustments to the flash mode setting, self-timer setting, macro mode setting, and exposure compensation value are cancelled and these settings return to their default scene values whenever another shooting mode is selected or the camera is turned off.

Shooting in the Scene Mode

Night portrait



Use this mode to achieve a natural balance between the main subject and background lighting in portraits shot at night.

- The camera detects and focuses on a face looking toward the camera (Shooting with Face Priority → 92).
- If the camera detects multiple faces, the camera focuses on the face closest to the camera.
- If no face is recognized, the camera will focus on the subject in the center focus area.
- Digital zoom is not available.

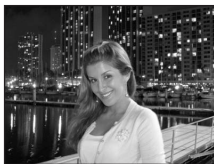

¹ Fill flash with slow sync and red-eye reduction.

² Other settings can be selected.

Party/indoor

Captures the effects of candlelight and other indoor background lighting.

- Camera focuses on subject in center of frame.
- As pictures are easily affected by camera shake, check the [Vibration reduction] (109) setting and hold the camera steadily.



¹ Fill flash with slow sync and red-eye reduction. Other settings can be selected.

² Other settings can be selected.

Beach/snow

Captures the brightness of such subjects as snowfields, beaches, or sunlit expanses of water.

- Camera focuses on subject in center of frame.



* Other settings can be selected.

: For those scene modes with , use of a tripod is recommended. Turn vibration reduction (109) [Off] when using a tripod.

: For those scene modes with , noise reduction is carried out automatically so the time taken to save an image will be longer than usual.

Sunset



Preserves the deep hues seen in sunsets and sunrises.

- Camera focuses at the center of frame.



* Other settings can be selected.

Dusk/dawn



Preserves the colors seen in the weak natural light before sunrise or after sunset.

- Camera focuses at infinity. When the shutter-release button is pressed halfway, the focus indicator ( 24) always lights; however, focus may not be set for near subjects, while the camera focuses at infinity.

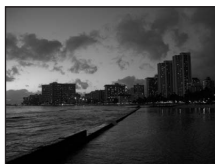

* Other settings can be selected.

Night landscape



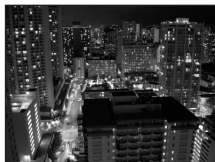

Slow shutter speeds are used to produce stunning night landscapes.

- Camera focuses at infinity. When the shutter-release button is pressed halfway, the focus indicator ( 24) always lights; however, focus may not be set for near subjects, while the camera focuses at infinity.



* Other settings can be selected.



: For those scene modes with , use of a tripod is recommended. Turn vibration reduction ( 109) [Off] when using a tripod.

: For those scene modes with , noise reduction is carried out automatically so the time taken to save an image will be longer than usual.

Shooting in the Scene Mode

Close up

Photograph flowers, insects and other small objects at close range.

- Macro mode (📷 31) will be turned [ON] and the camera automatically zooms to the position at the closest distance at which the camera can focus.
- The camera can focus at distances as close as 6 cm (2.4 in.) at the wide-angle zoom position at which  glows green. The closest distance at which the camera can focus varies depending upon zoom position. Digital zoom is not available.
- [AF area mode] is set to [Manual] (📷 90). When  is pressed, camera focuses on subject in active focus area.
- While the shutter-release button is pressed halfway, the camera focuses continuously until focus is acquired and locked.
- As pictures are easily affected by camera shake, check the [Vibration reduction] (📷 109) setting and hold the camera steadily.



* Other settings can be selected. Note that the flash may be unable to light entire subject at distances of less than 30 cm (11.8 in.)

Museum

Use indoors where flash photography is prohibited (for example, in museums and art galleries) or in other settings in which you do not want to use the flash.

- Camera focuses on subject in center of frame.
- BSS (best shot selector) can be used to shoot. (📷 86)
- As pictures are easily affected by camera shake, check the [Vibration reduction] (📷 109) setting and hold the camera steadily.

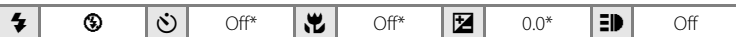

* Other settings can be selected.

Fireworks show



Slow shutter speeds are used to capture the expanding burst of light from a firework.

- Camera focuses at infinity. When the shutter-release button is pressed halfway, the focus indicator (📷 24) always lights; however, focus may not be set for near subjects, while the camera focuses at infinity.



Copy

Provides clear pictures of text or drawings on a white board or in print.

- Camera focuses on subject in center of frame.
- Use macro mode (📷 31) to focus at short ranges.
- Colored text and drawings may not show up well.

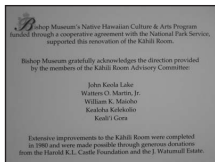

* Other settings can be selected.

Backlight

Use when light is coming from behind your subject, throwing features or details into shadow. The flash fires automatically to “fill in” (illuminate) shadows.

- Camera focuses on subject in center of frame.



* Other settings can be selected.

📷: For those scene modes with 📷, use of a tripod is recommended. Turn vibration reduction (📷 109) [Off] when using a tripod.

Panorama assist





Use when taking a series of pictures that will later be joined to form a single panorama using the supplied Panorama Maker software.



* Other settings can be selected.

Taking Pictures for a Panorama





The camera focuses on the subject in the center of the frame. Use a tripod for best results. Turn vibration reduction ( 109) [Off] when using a tripod to stabilize the camera during shooting.

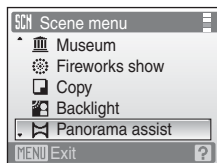





- 1 Use the rotary multi selector to choose [ Panorama assist] in the scene menu and press .

The yellow panorama direction icon () is displayed to show the direction in which pictures will be joined.



- 2 Use the rotary multi selector to choose the direction and press .

Select how pictures will be joined together in the completed panorama; right () left () up () or down ()

The panorama direction icon () is displayed to the direction pressed and changes to white when  is pressed. Apply flash mode () 28), self-timer () 30), macro mode () 31) and exposure compensation () 32) settings with this step, if necessary. Press  to reselect the direction.



3 Shoot the first picture.

The first picture is displayed in the first third of the monitor.

**4 Shoot the second picture.**

Compose the next picture so that it overlaps the first picture.

Repeat until you have shot the necessary number of pictures to complete the scene.



**5 Press OK when shooting is completed.**

The camera returns to step 2.

**✓ Panorama Assist**

- Flash mode (328), self-timer (330), macro mode (331) and exposure compensation (332) settings cannot be adjusted after the first picture is shot. Pictures cannot be deleted, nor can zoom or image mode setting (382) be adjusted until the series is finalized.
- The panorama series is terminated if the camera enters standby mode with the auto off function (3111) during shooting. Setting the time allowed to elapse before the auto off function is enabled to a longer setting is recommended.

🔒 Exposure Lock

 or  (when macro mode is applied) is displayed to indicate that white balance and exposure have been locked at the values set with the first shot. All pictures shot in a panorama series have the same exposure and white-balance settings.



Panorama Maker

Install Panorama Maker from the supplied Software Suite CD. Transfer pictures to a computer (📖 68) and use Panorama Maker (📖 71) to join them in a single panorama.

More Information

See "Image/Sound File and Folder Names" (📖 116) for more information.

Viewing Multiple Pictures: Thumbnail Playback

Press **W** (📷) in full-frame playback mode (📷 26) to display pictures in “contact sheets” of thumbnail images. The following operations can be performed while thumbnails are displayed.

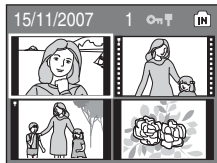

To	Use	Description	📷
Choose pictures		Press the rotary multi selector ▲, ▼, ◀, or ▶ or rotate the selector.	9
Change number of pictures displayed	W (📷) T (📷)	When W (📷) is pressed, display picture thumbnails in the following order: 4 → 9 → 16 When T (📷) is pressed, the number of thumbnails changes reversely.	-
Cancel thumbnail playback	OK	Press OK .	26
Switch to shooting mode	 	Press or the shutter-release button to return to the last shooting mode selected.	26

More on Playback

Thumbnail Playback Mode Display



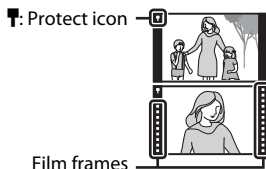



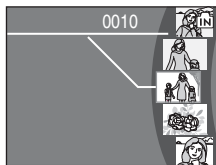

When protected pictures (📷 98) are displayed in thumbnail playback mode, the icons shown at right are displayed with them (except for 16 picture thumbnail playback mode). Movies are displayed as film frames.



Viewing Multiple Pictures: Thumbnail Wheel Playback

Rotating the rotary multi selector while in full-frame playback mode ( 26) will switch to thumbnail wheel playback mode. The thumbnail wheel is displayed at the right of the monitor. When rotation of the rotary multi selector is stopped, the thumbnail in the center will be selected and displayed at the left of the monitor. The following operations can be performed while thumbnail wheel is displayed.



To	Use	Description	
Choose a picture		Press the rotary multi selector ▲, ▼ or rotate the selector.	9
Switch to full-frame playback	 	Press  or  .	26
Switch to shooting mode	 	Press  or the shutter-release button to return to the last shooting mode selected.	26

Taking a Closer Look: Playback Zoom

Pressing **T** (Q) during full-frame playback mode (26) zooms the current picture in 3x, with the center of the picture displayed in the monitor (Quick Playback Zoom). The guide at lower right shows which portion of the picture is enlarged. Change the portion of the picture displayed by pressing the rotary multi selector ▲, ▼, ◀, or ▶.

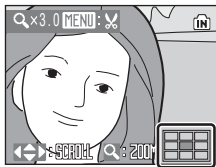

When using playback zoom with pictures shot using the face-priority function, the picture will be enlarged, with the face recognized during shooting, at the center of the monitor. If more than one face was recognized, the picture would be enlarged with the face, on which focus was acquired, at the center of the monitor. Press the rotary multi selector ▲, ▼, ◀, or ▶ to display a different recognized face.

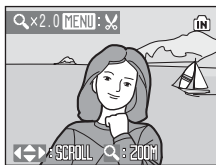

The magnification ratio can be changed further by operating the zoom buttons. The zoom ratio will be displayed in the monitor, and can be increased up to 10x. The following operations can be performed while pictures are zoomed in.



To	Use	Description	Page
Zoom in	T (Q)	Zoom increases each time T (Q) is pressed, to a maximum of 10x.	–
Zoom out	W ([checkered])	Zoom decreases each time W ([checkered]) is pressed. When the magnification ratio reaches 1x, the display returns to full-frame playback mode.	–
View other areas of picture		Press the rotary multi selector ▲, ▼, ◀ or ▶ to move the display area to other areas of the picture.	9
Switch to full-frame playback	OK	Press OK .	26
Crop picture	MENU	Press MENU to crop current picture to contain only the portion visible in the monitor.	48
Switch to shooting mode		Press or the shutter-release button to return to the last shooting mode selected.	26

Editing Pictures

Use the COOLPIX S700 to edit pictures in-camera and store them as separate files (📷 116). The editing features described below are available.

Editing function	Description
D-Lighting	Create a copy of the current picture with enhanced brightness and contrast, brightening dark portions of the picture.
Crop	Enlarge the image or refine the composition and create a copy containing only the portion visible in the monitor.
Small picture	Create a small copy of pictures suitable for use on web pages or as e-mail attachments.

Picture Editing

- Pictures shot at an image mode setting of [16:9] (📷 82) can not be edited.
- The COOLPIX S700 editing functions are not available for pictures shot with non-COOLPIX S700 digital cameras.
- If a copy created using the COOLPIX S700 is viewed on a different digital camera, the picture may not be displayed or may not be transferred to a computer.
- Editing functions are not available when there is not enough free space in the internal memory or on the memory card.

Restrictions on Picture Editing

(✓: available, -: not available)

1st editing	2nd editing		
	D-Lighting	Crop	Small picture
D-Lighting	-	✓	✓
Crop	-	-	-
Small picture	-	-	-

- Pictures cannot be edited twice with the same editing function.
- The D-Lighting should be done first while the restricted use of combination exists.

Original Pictures and Edited Copies

- Copies created with editing functions are not deleted if the original pictures are deleted. The original pictures are not deleted if copies created with editing functions are deleted.
- Edited copies are stored with the same recording date and time as the original.
- Edited copies are not marked for printing (📷 78) or protecting (📷 98) as the original.

Enhancing Brightness and Contrast: D-Lighting

D-Lighting can be used to create copies with enhanced brightness and contrast, brightening dark portions of a picture. Enhanced copies are stored as separate files.

- 1 Select the desired picture from full-frame (📄 26) or thumbnail (📄 43) playback mode and press **MENU**.

The playback menu will be shown.

Pictures can also be selected by using thumbnail wheel playback mode (📄 44).

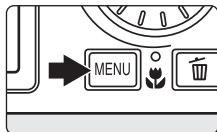

- 2 Choose [D-Lighting] with the rotary multi selector and press **OK**.

The original version will be shown on the left and the edited version will be shown on the right.

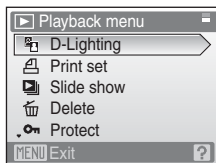

- 3 Choose [OK] and press **OK**.

A new copy with enhanced brightness and contrast is created.

To cancel D-Lighting, choose [Cancel] and press **OK**.

D-Lighting copies can be recognized by the 📄 icon displayed during playback.

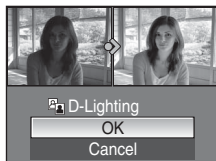

More Information

See "Image/Sound File and Folder Names" (📄 116) for more information.

Creating a Cropped Copy: Crop

This function is only available when **MENU: %** is displayed in the monitor with playback zoom (**Q** 45) enabled. Cropped copies are stored as separate files.

- 1 Press **T** (**Q**) in full-frame playback mode to zoom in on the image.

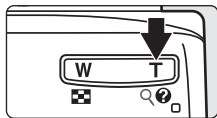

- 2 Refine copy composition.

Press **T** (**Q**) or **W** (**Q**) to adjust the zoom ratio.

Press the rotary multi selector **▲**, **▼**, **◀** or **▶** to scroll the picture until only the portion you want to copy is visible in the monitor.



- 3 Press **MENU**.

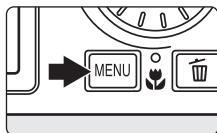

- 4 Use the rotary multi selector to choose [Yes] and press **OK**.

A new picture, containing only the portion visible in the monitor, is created.



Depending on the size of the original picture and the zoom ratio in effect at the time the copy was created, the camera will automatically select one of the following image mode settings for cropped copies (unit: pixels).

- **12M** 4,000 × 3,000
- **8M** 3,264 × 2,448
- **5M** 2,592 × 1,944
- **3M** 2,048 × 1,536
- **2M** 1,600 × 1,200
- **1M** 1,280 × 960
- **PC** 1,024 × 768
- **TV** 640 × 480
- **□** 320 × 240
- **□** 160 × 120



When the image mode setting for cropped copies is [**□** 320×240] or [**□** 160×120], these pictures are displayed with a gray frame.



More Information

See "Image/Sound File and Folder Names" (**Q** 116) for more information.

Resizing Pictures: Small Picture

Create a small copy of the current picture. Small copies are stored as JPEG files with a compression ratio of 1:16. The following sizes are available.

Option	Description
 640×480	Suited to television playback.
 320×240	Suited to display on web pages.
 160×120	Suitable for e-mail attachments.

- 1 Select the desired picture from full-frame () 26) or thumbnail () 43) playback mode and press **MENU**.

The playback menu is displayed.

Pictures can also be selected by using thumbnail wheel playback mode () 44).

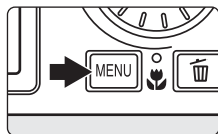

- 2 Use the rotary multi selector to choose [Small pic.] and press **OK**.

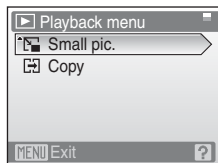

- 3 Choose the desired copy size and press **OK**.

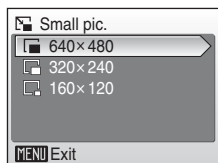

- 4 Choose [Yes] and press **OK**.

A new, smaller copy is created.

To cancel creating a small copy, choose [No] and press **OK**.

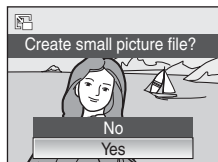

The copy is displayed with a gray frame.



More Information

See "Image/Sound File and Folder Names" () 116) for more information.

Voice Memos: Recording and Playback

Use the camera's built-in microphone to record voice memos for pictures marked with **OK** :  in full-frame playback mode ( 26).

Recording Voice Memos

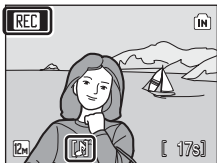
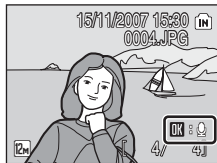

A voice memo, up to 20 seconds in length, will be recorded while **OK** is pressed down.

- Do not touch the built-in microphone during recording.
- During recording, **REC** and  blink in the monitor display.



Playing Voice Memos

Press **OK** while a picture is displayed in full-frame playback mode to play voice memo. Playback ends when the voice memo ends or **OK** is pressed again.

- Pictures with voice memos can be recognized by the **OK** :  and  icons.
- Use the zoom buttons to adjust playback volume.

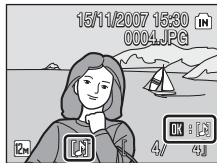

More on Playback

Deleting Voice Memos

Select a picture with a voice memo and press . Use the rotary multi selector to choose  and press **OK**. Only the voice memo will be deleted.



Voice Memos

- If a voice memo already exists for the current picture, it must be deleted before a new voice memo can be recorded.
- When a picture with a voice memo attached is deleted, both the picture and its voice memo are deleted.
- The COOLPIX S700 cannot be used to attach voice memos to pictures shot with cameras other than the COOLPIX S700.

More Information

See "Image/Sound File and Folder Names" ( 116) for more information.

Viewing Pictures by Date

In calendar mode or list by date mode, pictures shot on a specified date can be displayed. In full-frame playback mode, just as with playback mode, picture display can be enlarged, pictures can be edited, voice memos can be recorded or played back, and movies can be played back. When **MENU** is pressed, the calendar menu or the list by date menu is displayed, and all pictures shot on a specified date can be selected for deletion, printing, and protection.

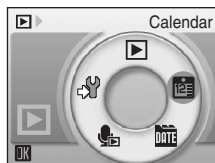
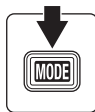

Selecting a Date in Calendar Mode

- 1 Enter calendar mode by pressing **MODE** in playback mode, selecting  (use the rotary multi selector), and then pressing **OK**.



- 2 Choose the desired date and press **OK**.

Dates for which pictures exist are underlined in yellow.

Press **W** () to view the previous month, or press **T** () to view the following month.

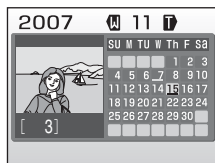

The first picture for that date will be displayed in full-frame playback mode.

Press **W** () in full-frame playback mode to return to calendar mode.

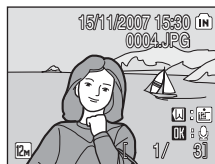

Selecting a Date in List by Date Mode

- 1 Enter list by date mode by pressing **MODE** in playback mode, selecting **DATE** (use the rotary multi-selector), and then pressing **OK**.

Dates for which pictures exist will be listed.

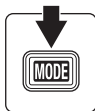

- 2 Choose the desired date and press **OK**.

Camera lists up to 29 dates. If pictures exist for more than 29 dates, all pictures recorded earlier than most recent 29 dates will be listed together as [Others].

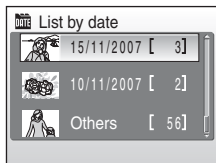





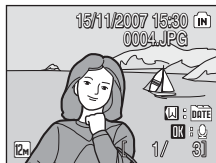









The first picture for that date will be displayed in full-frame playback mode.

Press **W** () in full-frame playback mode to return to the date list.



Using Calendar Mode and List by Date Mode

The following operations are possible from the date selection screen.







To	Use	Description	
Select date		A particular date can be selected by rotating the rotary multi-selector, or pressing it ▲, ▼, ◀, or ▶ in calendar mode, or ▲ or ▼ in list by date mode.	–
Select month (calendar mode only)	W  T 	Press W  to view the previous month, or press T  to view the following month.	–
Switch to full-frame playback		Press  to display the first picture shot on the selected date. Press W  in full-frame playback to return to the calendar or list by date mode selected before viewing in full-frame playback mode.	26
Delete picture		Press  after selecting a date, and a confirmation dialog will be displayed. Choose [Yes] and press  to delete all pictures shot on the selected date.	26
View calendar or list by date menu	MENU	Press MENU to display the calendar or list by date menu.	54
View playback-mode menu	MODE	Press MODE to display the playback-mode selection menu.	8
Switch to shooting mode	 	Press  or the shutter-release button to return to the last shooting mode selected.	26

Notes on Calendar Mode and List by Date Mode

- Only the most recent 9,000 pictures can be displayed in calendar mode or in list by date mode. If a date includes the 9,001st picture, an asterisk [*] is displayed next to the number of pictures for that date.
- Pictures shot with no date stamp are not listed in these modes.

Calendar and List by Date Menus

Press **MENU** in either mode to display the following menus for only the pictures shot on the specified date.

D-Lighting*	 47
Print set	 78
Slide show	 97
Delete	 98
Protect	 98
Small pic.*	 49

* During full-frame playback mode only

When **MENU** is pressed in the date selection screen ( 51, 52), options can be applied to all pictures shot on the same date, or all pictures shot on the same date can be deleted. To apply options to individual pictures, or to select individual pictures for deletion, display a picture full-frame and press **MENU**.

Print Set







When print marking already exists for pictures shot on dates other than that specified, a confirmation dialog [Save print marking for other dates?] will be displayed. Select [Yes] to add the new print marking to the existing marking. Select [No] to remove the existing print marking and leave only the new marking.

The Movie Menu







[Movie options], [Auto-focus mode] (📷 58), and [Electronic VR] (📷 58) settings can be changed from the movie menu. Press **MENU** in movie mode to display the movie menu and use the rotary multi selector to modify and apply settings.

Selecting Movie Options

The movie menu offers the options shown below.

Option	Image size and frame rate
 TV movie 640★ (default setting)	Image size: 640 × 480 pixels Frame rate for playback: 30 frames per second
 Small size 320★	Image size: 320 × 240 pixels Frame rate for playback: 30 frames per second
 Small size 320	Image size: 320 X 240 pixels Frame rate for playback: 15 frames per second
 Smaller size 160	Image size: 160 × 120 pixels Frame rate for playback: 15 frames per second
 Time-lapse movie ★	The camera automatically shoots pictures at intervals and joins them into a silent movie. Image size: 640 × 480 pixels Frame rate for playback: 30 frames per second
 Stop-motion movie	Pictures can be shot and joined into a silent movie. Image size: 640 × 480 pixels Frame rate for playback: choose from 5, 10, or 15 frames per second

Movie Options and Maximum Movie Length and Frames

Option	Internal memory (approx. 52 MB)	Memory card (256 MB)
 TV movie 640★ (default setting)	47 sec.	3 min. 40 sec.
 Small size 320★	1 min. 34 sec.	7 min. 20 sec.
 Small size 320	3 min. 4 sec.	14 min. 20 sec.
 Smaller size 160	10 min. 10 sec.	47 min. 40 sec.
 Time-lapse movie ★	555 frames	1,800 frames per movie
 Stop-motion movie	555 frames	1,800 frames per movie



* Movies can be as long as free space in the internal memory or on the memory card allows. All figures are approximate. Maximum movie length or frames varies with make of memory card. The maximum file size for movies is 4 GB.

More Information

See "Image/Sound File and Folder Names" ( 116) for more information.

Auto-focus Mode

Choose how the camera focuses in movie mode.

Option	Description
 Single AF (default setting)	Camera focuses when shutter-release button is pressed halfway and locks at this position during shooting.
 Full-time AF	Camera focuses continuously until focus is acquired and locked. To prevent sound of camera focusing from interfering with recording, use of [Single AF] is recommended.

Electronic VR

Enable or disable electronic VR for movie recording.

Option	Description
 On	Reduce the effects of camera shake in all movie modes except [Time-lapse movie ★] and [Stop-motion movie].
OFF Off (default setting)	Electronic VR is not enabled.

At settings other than [Off], the electronic vibration reduction icon is displayed in the monitor ( 6).

Time-Lapse Movies

Record flowers opening or butterflies emerging from cocoons.

- 1 Use the rotary multi selector to choose [Movie options] from the movie menu and press **OK**.

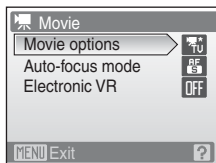

- 2 Choose [Time-lapse movie ★] and press **OK**.

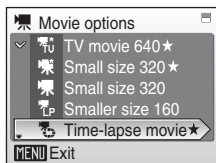

- 3 Choose the interval between shots and press **OK**.

Choose from intervals between 30 seconds and 60 minutes.

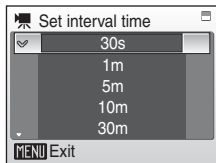

- 4 Press **MENU**.

The camera returns to shooting mode.

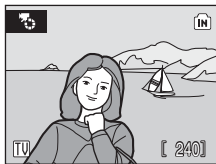

- 5 Press the shutter-release button all the way down to start recording.

Monitor turns off and power-on lamp blinks between shots.

Monitor reactivates automatically for the next shot.

- 6 Press the shutter-release button all the way down a second time to end recording.

Recording will automatically stop if the internal memory or memory card becomes full, or when 1,800 frames have been recorded. A 1,800-frame movie has a playback time of 60 seconds.

Stop-Motion Movies

Shoot a number of still pictures, at no specified interval, and join them for recording as a movie. Use to create a movie that simulates claymation.

- 1 Use the rotary multi selector to choose [Movie options] > [Stop-motion movie] and press **OK**.

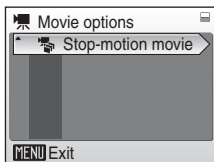

- 2 Choose playback speed and press **OK**.

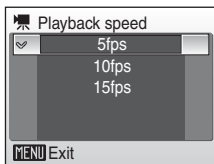

- 3 Press **MENU**.
The camera returns to shooting mode.

- 4 Press the shutter-release button to record the first frame.
The recorded picture will be superimposed on the view through the lens.



- 5 Press the shutter-release button to record the second frame.
Use the frame superimposed in the camera monitor as a guide for recording consecutive frames.
The monitor turns off automatically with the auto off function (📷 111) if no operations are performed for 30 minutes, and recording ends.

- 6 Press **OK** to stop recording when the desired number of frames has been shot.
Recording will automatically stop if the internal memory or memory card becomes full, or when 1,800 frames have been recorded.



✔ Time-Lapse Movie and Stop-Motion Movie

- Flash mode (📷 28), macro mode (📷 31), and exposure compensation (📷 32) cannot be adjusted after the first picture is shot. Apply the appropriate settings before shooting begins.
- To prevent the camera from turning off unexpectedly during recording, use a fully charged battery.

Movie Playback







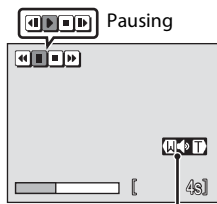



In full-frame playback mode ( 26), movies are recognized by the movie mode icons. To play a movie, display it in full-frame playback mode and press .

- The movie mode icon varies depending upon a movie option ( 56) selected in shooting mode.

Use the zoom buttons to adjust playback volume. Playback controls appear at the top of the monitor. Press the rotary multi selector  or  to choose a control, then press  to perform the selected operation. The following operations are available.









Volume indicator
During playback

To	Press	Description
Rewind*		Rewind movie. Playback resumes when  is released.
Advance*		Advance movie. Playback resumes when  is released.
Pause		Pause playback. While paused, use the rotary multi selector to advance or rewind the movie. The following operations can be performed while playback is paused.
		 Rewind movie by one frame. Rewind continues while  is pressed.
		 Advance movie by one frame. Advance continues while  is pressed.
		Resume playback.
End		End playback and return to full-frame playback.

* Rotating the rotary multi selector also advances or rewinds the movie.

Deleting Movie Files

Press  when being played back, or when displayed in full-frame playback mode ( 26), or when selected in thumbnail ( 43) or thumbnail wheel ( 44) playback mode. A confirmation dialog is displayed. To delete the movie, select [Yes] and press . To exit without deleting the movie, select [No] and press .

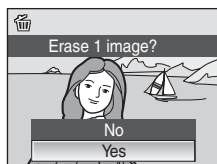

Making Voice Recordings

Audio voice recordings can be recorded over the built-in microphone and played back over the built-in speaker.

- 1 Enter voice recording mode by pressing **MODE** in shooting mode, selecting  (use the rotary multi selector), and then pressing **OK**.

The length of recording that can be made will be displayed.

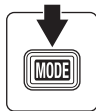

- 2 Press the shutter-release button all the way down to start recording.

The indicator lamp lights during recording. If no operations are performed for about 30 seconds after voice recording begins, the camera's auto off function is enabled and the monitor turns off.

See "Operations During Recording" ( 63) for more information.

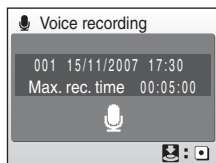





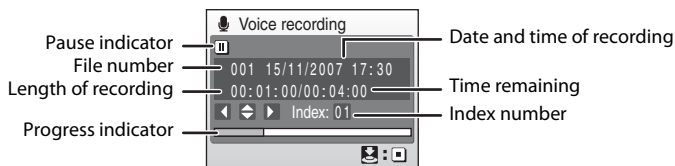

- 3 Press the shutter-release button all the way down a second time to end recording.

Recording will end automatically if the internal memory or memory card becomes full, or after five hours of recording on the memory card.

More Information

Operations During Recording





To	Press	Description
Reactivate the monitor		If the monitor has turned off, press  to reactivate.
Pause/resume recording		Press once to pause recording; indicator lamp will blink.
Create index*		During recording, press the rotary multi selector to create index. Camera can skip to any intended index during playback. Start of recording is index number 01; other numbers that follow are assigned in ascending order each time the rotary multi selector is pressed, up to index number 98.
End recording		Press the shutter-release button all the way down a second time to end recording.

* The copied files can be played back using QuickTime or any other WAV-compatible audio player. Note that index points created with the camera cannot be used when voice recordings are played back on computers.

Playing Voice Recordings

- 1 Enter audio playback mode by pressing **MODE** in playback mode, selecting  (use the rotary multi selector), and then pressing **OK**.

Voice recordings can also be played back by pressing  in voice recording mode ( 62) to display the select sound file screen.



- 2 Use the rotary multi selector to choose the desired file and press **OK**.

The selected sound file will be played back.

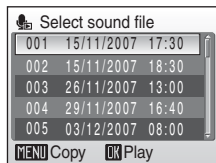

Operations During Playback

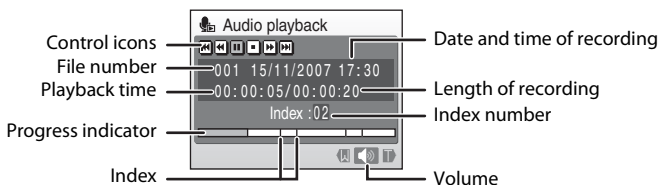

Use the zoom buttons to adjust audio playback volume.

Playback controls appear at the top of the monitor. Press the rotary multi selector ◀ or ▶ to choose a control, then press OK to perform the selected operation. The following operations are available.

To	Press	Description
Rewind*	◀◀	Rewind voice recording. Playback resumes when OK is released.
Advance*	▶▶	Advance voice recording. Playback resumes when OK is released.
Skip to previous index	◀◀	Skip to previous index.
Skip to next index	▶▶	Skip to next index.
Pause	⏸	Pause playback.
	▶	The following operations can be performed while playback is paused: Resume playback.
End	■	End playback and return to the sound file selection screen.

* Rotating the rotary multi selector also advances or rewinds the voice recording.

Deleting Sound Files

Press  during playback or after selecting a sound file (use the rotary multi selector). A confirmation dialog will be displayed. To delete the file, select [Yes] and press OK. To exit without deleting the file, select [No] and press OK.

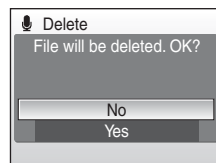

Copying Voice Recordings

Copy voice recordings between the internal memory and a memory card. This option is available only when a memory card is inserted.

- 1 Press **MENU** in the select sound file screen (☒ 64, step 2).

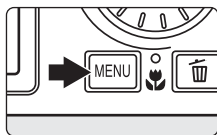

- 2 Use the rotary multi selector to choose the option and press **OK**.

: Copy recordings from internal memory to memory card

: Copy recordings from memory card to internal memory

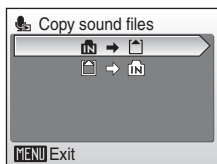

- 3 Choose the copy option and press **OK**.

[Selected files]: Proceed to step 4

[Copy all files]: Proceed to step 5

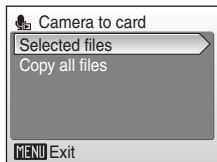

- 4 Choose the desired file.

Press the rotary multi selector to select the file (✓✓).
Press the rotary multi selector again to cancel the selection.

- Multiple files can be selected.
- Press **OK** to finalize file selection.

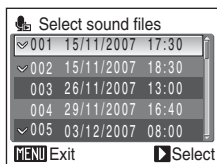

- 5 When a confirmation dialog is displayed, choose [Yes] and press **OK**.

Copying starts.

Voice Recordings

The COOLPIX S700 may be unable to play or copy sound files created with non-COOLPIX S700 digital cameras.

[No sound file.] Message

If there are no sound files stored on the memory card when is selected (☒ 64, step 1), the message [No sound file.] will be displayed. Press **MENU** to display the copy sound files screen, and copy the sound files stored in the camera's internal memory to the memory card.

Connecting to a TV

Connect the camera to a television using the supplied audio video/USB cable to play back pictures on the television.

1 Turn off the camera.

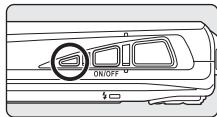

2 Connect the camera to the TV using the supplied audio video/USB cable.

Connect the yellow plug to the video-in jack on the TV, and the white plug to the audio-in jack.

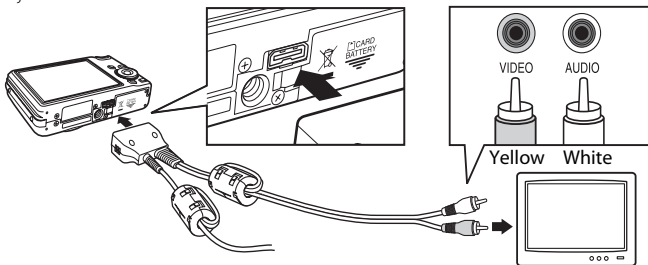

3 Tune the television to the video channel.

See the documentation provided with your television for details.

4 Hold down to turn on the camera.

The camera enters playback mode, and the pictures recorded to the internal memory, or memory card, will be displayed on the television.

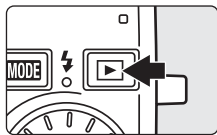

While connected to the TV, the camera monitor will remain off.



Connecting an Audio Video/USB Cable

- When connecting the audio video/USB cable, be sure that the camera connector is oriented correctly. Do not use force when connecting the audio video/USB cable to the camera. When disconnecting the audio video/USB cable, do not pull the connector at an angle.
- When connecting to a TV, do not use the audio video/USB cable's USB connector. If the USB connector is inserted in a computer or printer's USB port, be sure to disconnect it.

Video Mode

Be sure that the camera's video mode setting conforms to the standard used by your television. The video mode setting is an option set in the setup menu ( 100) > [Video mode] ( 112).

Connecting to a Computer

When the camera is connected to a computer using the supplied audio video/USB cable, pictures recorded with the camera can be copied (transferred) to the computer for storage using the Nikon Transfer software.

Before Connecting the Camera

Install the Software

Before connecting the camera to a computer, software, including Nikon Transfer and Panorama Maker for creating panorama images, must be installed from the supplied Software Suite CD.

For more information on installing the software, refer to the *Quick Start Guide*.

Operating Systems Compatible with COOLPIX S700

Windows

Preinstalled versions of Windows Vista (32-bit Home Basic/Home Premium/Business/Enterprise/Ultimate editions), Windows XP Service Pack 2 (Home Edition/Professional)

If your computer is running Windows 2000 Professional, use a card reader or similar device to transfer pictures stored on the memory card to the computer (70).

Macintosh

Mac OS X (version 10.3.9, 10.4.9)

Refer to the Nikon website for the latest information on operating system compatibility.

Note on Power Source

When connecting the camera to a computer or printer, use a fully charged battery to prevent the camera from turning off unexpectedly.

Transferring Pictures from a Camera to a Computer

- 1 Start the computer to which Nikon Transfer was installed.
- 2 Turn off the camera.
- 3 Connect the camera to the computer using the supplied audio video/USB cable.

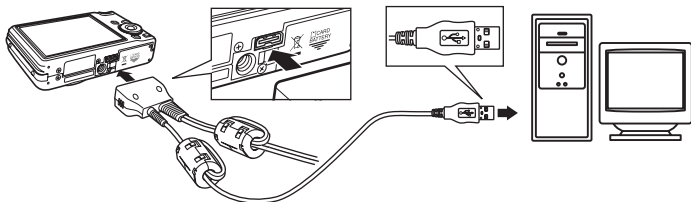

- 4 Turn on the camera.

Windows Vista

When the AutoPlay dialog is displayed, select [Copy pictures to a folder on my computer using Nikon Transfer]. Nikon Transfer will start. To bypass this dialog in the future, check [Always do this for this device:].

Windows XP

When the AutoPlay dialog is displayed, select [Nikon Transfer Copy pictures to a folder on my computer] and click [OK]. Nikon Transfer will start. To bypass this dialog in the future, check [Always use this program for this action.].

Mac OS X

Nikon Transfer will start automatically if [Yes] was selected in the Auto-Launch setting dialog when Nikon Transfer was first installed.

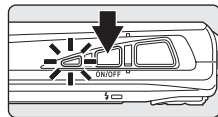

✓ Connecting the Audio Video/USB Cable

- When connecting the audio video/USB cable, be sure that the connectors are oriented correctly. Do not use force when connecting the audio video/USB cable. When disconnecting the audio video/USB cable, do not pull the connector at an angle.
- Connection may not be recognized when the camera is connected to a computer via a USB hub.

5 Transfer pictures when Nikon Transfer has finished loading.

Click [Start Transfer] in Nikon Transfer. At the default setting, all pictures are transferred to the computer.

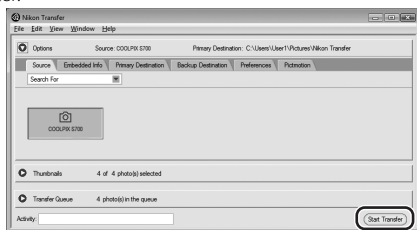

[Start Transfer] button

At the Nikon Transfer default setting, the folder to which pictures are transferred is automatically opened when transfer is complete.

For more information on using Nikon Transfer, refer to help information contained in Nikon Transfer.

6 Disconnect the camera when transfer is complete.

Turn the camera off and disconnect the audio video/USB cable.

For Users of Windows 2000 Professional

Use a card reader or similar device to transfer the pictures stored on the memory card to the computer.

If your memory card has a capacity greater than 2 GB, the intended device must support the memory card.

- At the Nikon Transfer default settings, Nikon Transfer will start automatically when a memory card is inserted into the card reader or similar device. See step 5 above to transfer pictures.
- Do not connect the camera to the computer. If the camera is connected to the computer, the [Found New Hardware Wizard] dialog will be displayed. Select [Cancel], close the dialog, and disconnect the camera from the computer.
- To transfer pictures stored in the camera's internal memory to the computer, the pictures must first be copied to a memory card using the camera (▶ 66, 95, 99).

Using Standard OS Operations to Open Image/Sound Files

- Navigate to the folder on the computer's hard disk to which pictures were saved and open a picture in the viewer supplied with your operating system.
- Sound files copied to the computer can be played back using QuickTime or any other WAV-compatible audio player.

Panorama Creation with Panorama Maker

- Use a series of pictures shot using the [Panorama assist] option in scene mode (F3 40) to create a single panorama photo with Panorama Maker.
- Panorama Maker can be installed to a computer using the supplied Software Suite CD. After installation is complete, follow the procedure described below to start Panorama Maker.

Windows

Open [All Programs] ([Programs] under Windows 2000) from the [Start] menu > [ArcSoft Panorama Maker 4] > [Panorama Maker 4].

Macintosh

Open Applications by selecting [Applications] from the [Go] menu, and double-click the [Panorama Maker 4] icon.

- For more information on using Panorama Maker, refer to the on-screen instructions and help information contained in Panorama Maker.

More Information

See "Image/Sound File and Folder Names" (F3 116) for more information.

Connecting to a Printer

Users of PictBridge-compatible (📷 132) printers can connect the camera directly to the printer and print pictures without using a computer.

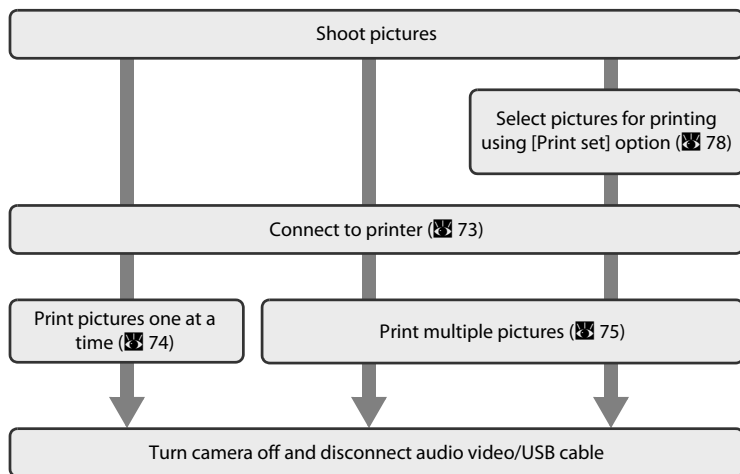

✔ Note on Power Source

When connecting the camera to a computer or printer, use a fully charged battery to prevent the camera from turning off unexpectedly.

📷 Printing Pictures

In addition to printing pictures transferred to a computer from your personal printer and printing over a direct camera-to-printer connection, the following options are also available for printing pictures:

- Insert a memory card into a DPOF-compatible printer's card slot
- Take a memory card to a digital photo lab

For printing using these methods, specify the pictures and the number of prints each using your camera's print set menu (📷 78).

Connecting the Camera and Printer

- 1 Turn off the camera.

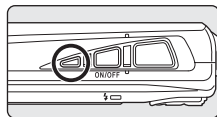

- 2 Turn on the printer.

Check printer settings.

- 3 Connect the camera to the printer using the supplied audio video/USB cable.

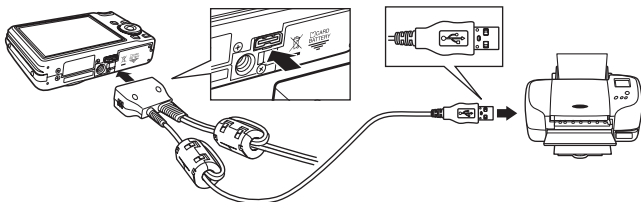

- 4 Turn on the camera.

When connected correctly, the PictBridge startup screen ① will be displayed in the camera monitor. Then the print selection screen will be displayed ②.

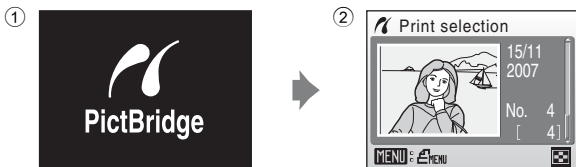
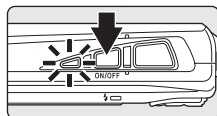

✓ Connecting the Audio Video/USB Cable

When connecting the audio video/USB cable, be sure that the connectors are oriented correctly. Do not use force when connecting the audio video/USB cable. When disconnecting the audio video/USB cable, do not pull the connector at an angle.

Printing Pictures One at a Time

After connecting the camera to the printer correctly (▶ 73), print pictures by following the procedure below.

- 1 Use the rotary multi selector to choose the desired picture and press **OK**.

Press **W** (◀▶) to display 12 thumbnails, and **T** (⌂) to switch back to full-frame playback.

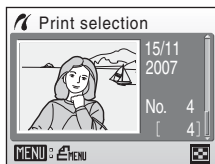

- 2 Choose [Copies] and press **OK**.

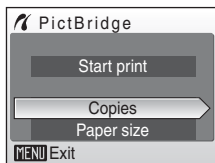

- 3 Choose the number of copies (up to nine) and press **OK**.

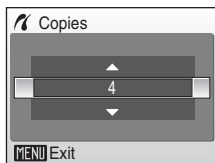

- 4 Choose [Paper size] and press **OK**.

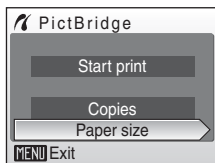

- 5 Choose the desired paper size and press **OK**.

To specify paper size using printer settings, choose [Default] in the paper size menu.

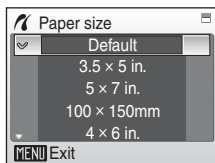

- 6** Choose [Start print] and press **OK**.

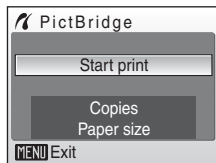

- 7** Printing starts.

Monitor display returns to that shown in step 1 when printing is complete.

To cancel before all copies have been printed, press **OK**.

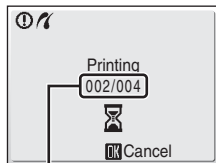

Current print/total number of prints

Printing Multiple Pictures

After connecting the camera to the printer correctly (p. 73), print pictures by following the procedure below.

- 1** When the print selection screen is displayed, press **MENU**.

The print menu is displayed.

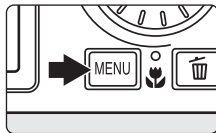

- 2** Use the rotary multi selector to choose [Paper size] and press **OK**.

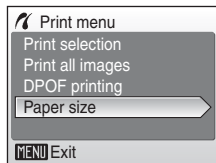

- 3** Choose the desired paper size and press **OK**.

To specify paper size using printer settings, choose [Default] in the paper size menu.

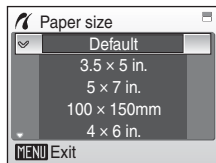

- 4** Choose [Print selection], [Print all images] or [DPOF printing] and press **OK**.

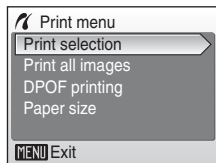

Print selection

Choose the pictures and number of copies (up to nine) of each.

Rotate the rotary multi selector, or press **◀** or **▶**, to select pictures, and press **▲** or **▼** to set the number of copies for each.

Pictures selected for printing can be recognized by the check mark (✓) and the numeral indicating the number of copies to be printed. A check mark is not displayed with pictures for which no copies have been specified and these pictures will not be printed.

Press **T** (📄) to switch to full-frame playback.

Press **W** (🖼️) to switch back to thumbnail display.

Press **OK** when print setup is complete.

The menu shown at right will be displayed.

To print, choose [Start print] and press **OK**.

Choose [Cancel] and press **OK** to return to the print menu.

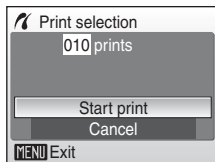
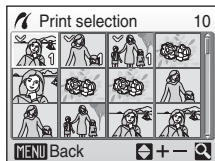

Print all images

All pictures stored in the internal memory, or on the memory card, are printed one at a time.

The menu shown at right will be displayed.

To print, choose [Start print] and press **OK**.

Choose [Cancel] and press **OK** to return to the print menu.

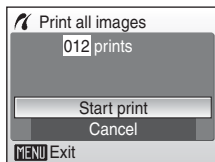

DPOF printing

Print pictures for which a print order was created in [Print set] (78).

- The menu shown at right will be displayed.
- To print, choose [Start print] and press **OK**.
- Choose [Cancel] and press **OK** to return to the print menu.
- To view the current print order, choose [View images] and press **OK**. To print pictures, press **OK** again.

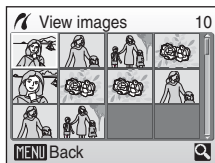
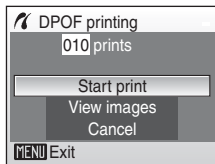
**5 Printing starts.**

Monitor display returns to the print menu (step 2) when printing is complete.

To cancel before all copies have been printed, press **OK**.

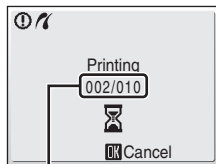

Current print/total number of prints

✓ Paper Size

The camera supports the following paper sizes: [Default] (the default paper size for the current printer), [3.5 × 5 in.], [5 × 7 in.], [100 × 150mm], [4 × 6 in.], [8 × 10 in.], [Letter], [A3], and [A4]. Only sizes supported by the current printer will be displayed. To specify paper size using printer settings, choose [Default] in the paper size menu.

Creating a DPOF Print Order: Print Set

The [Print set] option in the playback menu is used to create digital "print orders" for printing on DPOF-compatible devices (132).

When the camera is connected to a PictBridge-compatible printer, pictures can be printed from the printer according to the DPOF print order you have created for pictures on the memory card. If the memory card is removed from the camera, you can create the DPOF print order for pictures in the internal memory and print pictures according to the DPOF print order.

1 Press MENU in playback mode.

The playback menu is displayed.

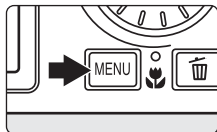

2 Use the rotary multi selector to choose [Print set] and press OK.

The print set menu is displayed.



3 Choose [Print selected] and press OK.

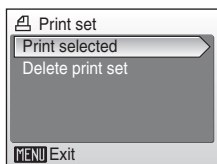

4 Choose the pictures and number of copies (up to nine) of each.

Rotate the rotary multi selector, or press ◀ or ▶, to select pictures, and press ▲ or ▼ to set the number of copies for each.

Pictures selected for printing can be recognized by the check mark (✓) icon and the numeral indicating the number of copies to be printed. A check mark is not displayed with pictures for which no copies have been specified and these pictures will not be printed.

Press **T** (Q) to switch to full-frame playback.

Press **W** (R) to switch back to thumbnail display.

Press **OK** when setting is complete.

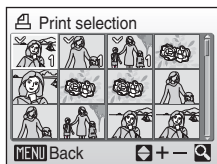



5 Choose whether or not to also print shooting date and photo information.

Choose [Date] and press **OK** to print date of recording on all pictures in the print order.

Choose [Info] and press **OK** to print photo information (shutter speed and aperture) on all pictures in the print order.

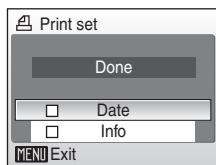
Choose [Done] and press **OK** to complete the print order and exit.



Pictures selected for printing are recognized by the  icon displayed with playback.

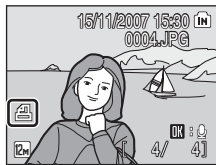

Note on Printing Shooting Date and Photo Information

- When the [Date] and [Info] options are enabled in the print set menu, shooting date and photo information are printed on pictures when a DPOF-compatible (**85** 132) printer which supports printing of shooting date and photo information is used.
- Photo information cannot be printed when the camera is connected directly to a printer, via the supplied audio video/USB cable, for DPOF printing (**85** 77).
- [Date] and [Info] are reset each time the print set menu is displayed.

Deleting All Print Orders

Choose [Delete print set] in step 3 and press **OK**. Print orders for all pictures will be deleted.

Note on the Print Set [Date] Option

The date and time printed on pictures with DPOF printing when [Date] in the print set menu is enabled, are those recorded with the picture as it was shot. Date and time printed using this option are not affected when the camera's date and time setting are changed from the setup menu after pictures are recorded.



Date Imprint

When date and time of recording are imprinted on pictures using the [Date imprint] option (**85** 107) in the setup menu, pictures with the date and time imprinted on them can be printed from printers that do not support printing of the date and time on pictures. Only the [Date imprint] date and time on pictures will be printed, even if [Print set] is enabled with [Date] selected in the print set screen.

Connecting to a ImageLink-compatible Printer

See documentation provided with your printer for information on operating the printer.

- 1 Attach the Dock Insert PV-17 (supplied) to the printer.

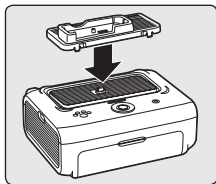

- 2 Turn the camera off and attach it to the dock insert.

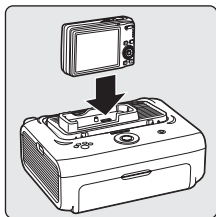

- 3 Print pictures.

Follow the procedures described in the printer manual.

Removing the Dock Insert

Place your thumbs where indicated, press, and lift.

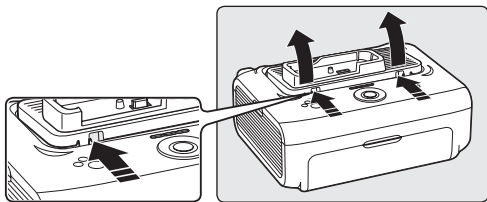















✓ Note on Connecting to an ImageLink-compatible Printer

The monitor will dim automatically if no operations are performed for about one minute while the camera is connected to an ImageLink printer. The camera will turn off if no operations are performed for about another seven minutes.

Shooting Options: The Shooting Menu

The shooting menu and high-sensitivity menu contain the following options.





	Image mode ^{1,2}	 82
	Choose image size and quality.	
	White balance ²	 84
	Match white balance to the light source.	
	Continuous ²	 86
	Change settings for Continuous or BSS (best shot selector)	
	ISO sensitivity ^{2,3}	 88
	Control camera's sensitivity to light.	
	Color options ²	 89
	Apply color effects to pictures as they are recorded.	
	AF area mode	 90
	Choose where the camera focuses.	
	Distortion control ²	 93
	Correct the distortion.	

¹ Settings can be applied from other shooting menus (except movie menu).

² See the information on restrictions that may apply to these settings ( 93).

³ This setting cannot be set in the high-sensitivity menu.

Displaying the Shooting Menu and High-sensitivity Menu

Enter  (auto) or high-sensitivity shooting mode by pressing **MODE** in shooting mode, selecting  (auto) or  (high-sensitivity), and then pressing . Press **MENU** to display the shooting menu or high-sensitivity menu.

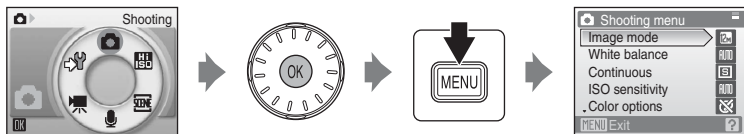











- Use the rotary multi selector to choose and apply settings ( 99).
- To return to the shooting mode from the shooting or high-sensitivity menu, press **MENU** or the shutter-release button.

Image Mode

Pictures shot with a digital camera are recorded as image files. The size of the files, and with it the number of images that can be recorded, depends on the size and quality of the images. Before shooting, choose an image mode according to how you plan to use the picture and the capacity of the internal memory or memory card. The larger the image, the larger the size at which it can be printed or displayed without becoming noticeably “grainy,” limiting the number of pictures that can be recorded.

Option	Size (pixels)	Description
 High (4000★)	4,000 × 3,000	Highest quality, suitable for enlargements or high-quality prints. The compression ratio is approximately 1:4.
 Normal (4000) (default setting)	4,000 × 3,000	More detailed pictures than [ Normal (3264)] and [ Normal (2592)]. The compression ratio is approximately 1:8.
 Normal (3264)	3,264 × 2,448	Best choice in most situations. The compression ratio is approximately 1:8.
 Normal (2592)	2,592 × 1,944	
 Normal (2048)	2,048 × 1,536	Smaller size allows more pictures to be stored. The compression ratio is approximately 1:8.
 PC screen (1024)	1,024 × 768	Suited to display on a computer monitor. The compression ratio is approximately 1:8.
 TV screen (640)	640 × 480	Suited to full-screen display on a television, or distribution by e-mail or the web. The compression ratio is approximately 1:8.
 16:9	3,968 × 2,232	Pictures with an aspect ratio of 16:9 can be shot. The compression ratio is approximately 1:8.









The icon for the current setting is displayed in the monitor in shooting and playback modes ( 6, 7).

Image Mode

Changes made to these settings apply to all shooting modes (except movie mode).

Number of Exposures Remaining

The following table lists the approximate number of pictures that can be stored in internal memory and on a 256 MB memory card. Note that the number of pictures that can be stored will differ depending on the composition of the picture (due to JPEG compression). In addition, this number may differ depending on the make of memory card, even if the capacity for the memory card is the same.

Setting	Internal memory (approx. 52 MB)	Memory card ¹ (256 MB)	Print size (printed at 300 dpi; cm/in.) ²
 High (4000★)	9	40	34 × 25/13.3 × 10
 Normal (4000)	17	80	34 × 25/13.3 × 10
 Normal (3264)	26	120	28 × 21/11 × 8.3
 Normal (2592)	41	195	22 × 16.5/8.8 × 6.6
 Normal (2048)	65	305	17 × 13/6.8 × 5.2
 PC screen (1024)	222	1,040	9 × 7/3.6 × 2.8
 TV screen (640)	416	1,950	5 × 4/2 × 1.6
 16:9	24	110	34 × 19/13.2 × 7.5

¹ If the number of exposures remaining is 10,000 or more, the number of exposures remaining display shows [9999].

² Print sizes are calculated by dividing the number of pixels by printer resolution (dpi) and multiplying by 2.54 cm (1 in.). However, at the same image size, pictures printed at higher resolutions will print smaller than the size indicated, and those printed at lower resolutions will print larger than the size indicated.

WB White Balance

The color of light reflected from an object varies with the color of the light source. The human brain is able to adapt to changes in the color of the light source, with the result that white objects appear white whether seen in the shade, direct sunlight, or under incandescent lighting. Digital cameras can mimic this adjustment by processing images according to the color of the light source. This is known as “white balance.” For natural coloration, choose a white balance setting that matches the light source before shooting. Although the default setting, [Auto], can be used under most types of lighting, you can apply the white balance setting suited to a particular light source to achieve more accurate results.

Auto (default setting)

White balance automatically adjusted to suit lighting conditions. Best choice in most situations.

Preset manual

Neutral-colored object used as reference to set white balance under unusual lighting conditions. See “Preset Manual” ( 85) for more information.

Daylight

White balance adjusted for direct sunlight.

Incandescent

Use under incandescent lighting.

Fluorescent

Use under most types of fluorescent lighting.

Cloudy

Use when shooting under overcast skies.

Flash

Use with the flash mode.

The effects of the selected option can be previewed in the monitor. At settings other than [Auto], the icon for the current setting is displayed in the monitor ( 6).

Flash Mode

At white-balance settings other than [Auto] or [Flash], turn the flash off (  28).

Preset Manual

Preset manual is used with mixed lighting or to compensate for light sources with a strong color cast (for example, to make pictures shot under a lamp with a red shade look as though they had been shot under white light).

- 1 Place a white or gray reference object under the lighting that will be used during shooting.

- 2 Use the rotary multi selector to choose [PRE Preset manual] in the [White balance] menu, and press **OK**.

The camera zooms in.

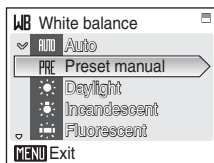

- 3 Choose [Measure].

To apply the most recently measured value for preset manual, choose [Cancel] and press **OK**.

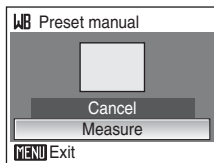

- 4 Frame the reference object.

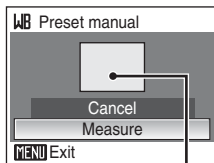

Reference object frame

- 5 Press **OK**.

The shutter is released and the new white-balance value is set.
No pictures are recorded.

✓ Note on Preset Manual

Regardless of the flash mode selected, the flash will not fire when **OK** is pressed in step 5. Therefore, the camera cannot measure a value for preset manual for when the flash is used.

Continuous

Change settings to Continuous or Best Shot Selector (BSS). Flash will be switched off when [Continuous], [BSS], or [Multi-shot 16] is selected. Focus, exposure and white balance are fixed at the values for the first picture in each series.

Single (default setting)

One picture is shot each time shutter-release button is pressed.

Continuous

While the shutter-release button is held down, up to 5 pictures are shot at a rate of about 1.0 frames per second (fps) when [Image mode] is set to  Normal (4000)].

BSS

The “best shot selector” is recommended when shooting with the flash off or the camera zoomed in, or in other situations in which inadvertent motion can result in blurred pictures. When BSS is on, the camera shoots up to ten pictures while the shutter-release button is held down. The sharpest picture in the series is automatically selected and saved.

Multi-shot 16

Each time shutter-release button is pressed, camera shoots 16 pictures at about 1.0 frames per second and arranges them in a single picture with image mode setting  Normal (2592)].

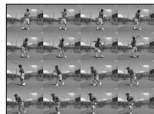

Intvl timer shooting

Camera shoots (up to 1,800 frames) automatically at specified interval  87).

At settings other than [Single], the indicator for the current setting is displayed in the monitor  6).

Note on Continuous Shooting

- The maximum frame rate with continuous shooting may vary, depending upon the current image mode setting and the memory card used.
- Digital zoom cannot be used in [Multi-shot 16].
- At an [ISO sensitivity]  88) setting of [3200], the [Multi-shot 16] option is not available. When shooting with the [Multi-shot 16] option, select options other than [3200] for [ISO sensitivity] and select [Multi-shot 16] for [Continuous].

Note on BSS

BSS may not produce the desired results if the subject moves or the composition changes while the shutter-release button is pressed all the way down.

Interval Timer Photography

Pictures are shot automatically at specified intervals. Choose from intervals between 30 seconds and 60 minutes.

- 1 Use the rotary multi selector to choose [Intvl timer shooting] in the [Continuous] menu, and press **OK**.

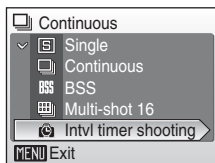

- 2 Choose interval between shots and press **OK**.

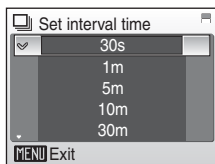

- 3 Press **MENU**.

The camera returns to shooting mode.

- 4 Press the shutter-release button all the way down to shoot the first picture and initiate interval timer shooting.

Monitor turns off and power-on lamp blinks between shots.

The monitor turns on automatically right before the next picture is shot.

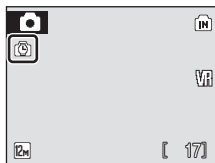

- 5 Press the shutter-release button all the way down a second time to end recording.

Recording will end automatically if the internal memory or memory card becomes full, or when 1,800 pictures have been shot.

Power Source

To prevent the camera from turning off unexpectedly during recording, use a fully charged battery.

More Information

See "Image/Sound File and Folder Names" ( 116) for more information.

ISO ISO Sensitivity

Sensitivity is a measure of how quickly the camera reacts to light. The higher the sensitivity, the less light needed to make an exposure. Although a high ISO rating is suited for shooting pictures of subjects in action or in poor lighting, high sensitivity is often associated with “noise” - randomly spaced, brightly colored pixels concentrated in dark parts of the image.

Auto (default setting)







Sensitivity is ISO 64 under normal conditions; when lighting is poor and the flash is off, the camera compensates by raising sensitivity to a maximum of ISO 1000.

64, 100, 200, 400, 800, 1600, 2000, 3200

Sensitivity will be locked at the specified value.

At the settings other than [Auto], the current setting is displayed in the monitor (📷 6). If [Auto] is selected and the sensitivity is raised above ISO 64, the  icon will be displayed (📷 29).

ISO 3200

- When [3200] is selected for ISO sensitivity, image mode is displayed in red.
- When [ISO sensitivity] is set to [3200], [Image mode] cannot be set to  (4,000 × 3,000),  (4,000 × 3,000),  (3,264 × 2,448), and  (3,968 × 2,232). At these image mode settings, selecting [3200] for [ISO sensitivity] automatically switches the [Image mode] setting to  (2,592 × 1,944). When any option other than [3200] is next selected for [ISO sensitivity], the original image mode setting is restored.
- At an [ISO sensitivity] setting of [3200], the [Multi-shot 16] ( 86) option of the continuous shooting mode is not available. At a [Continuous] setting of [Multi-shot 16], selecting [3200] for [ISO sensitivity] switches the [Continuous] setting to [Single]. The [Continuous] setting does not change even when [ISO sensitivity] is set to options other than [3200].

Color Options

Make colors more vivid or record pictures in monochrome.



Standard color (default setting)

Use for pictures exhibiting natural color.



Vivid color

Use to achieve a vivid, “photoprint” effect.



Black-and-white

Record pictures in black-and-white.



Sepia

Record pictures in sepia tones.



Cyanotype

Record pictures in cyan-blue monochrome.

The effects of the selected option can be previewed in the monitor. At settings other than [Standard color], the icon for the current setting is displayed in the monitor ( 6).

[+] AF Area Mode

Use this option to determine where the camera focuses.

When digital zoom is effect, the camera will focus on the subject in the center focus area regardless of the applied [AF area mode] option.



Face priority (default setting)

The camera automatically detects and focuses on a face looking toward the camera (Shooting with Face Priority → 92). If the camera detects multiple faces, the camera focuses on the face closest to the camera.

When shooting pictures of subjects other than people, or framing a subject with which no face is recognized, [AF area mode] will be set to [Auto]. The camera chooses the focus area (one of nine) containing the subject closest to the camera and focuses on the subject.

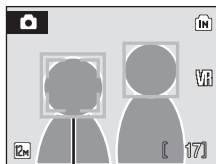

Focus area



Auto

Camera automatically selects the focus area (one of nine) containing the subject closest to the camera. Press the shutter-release button halfway to activate the focus area. When the shutter-release button is pressed halfway, the focus area selected by the camera will be displayed in the monitor.

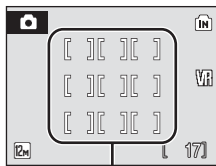

Focus area



Manual

This option is suited to situations in which the intended subject is relatively still and not positioned in the center of the frame.

Press the rotary multi selector ▲, ▼, ◀ or ▶ to select from 99 focus areas in the frame. Pictures can be shot while focus-area selection screen is displayed.

To end focus-area selection and adjust the flash mode, macro mode, self-timer and exposure compensation settings, press **OK**. To return to the focus-area selection screen, press **OK**.

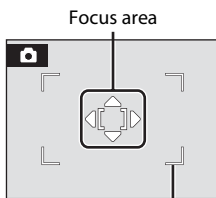

Selectable focus areas

[C] Center

Camera focuses on subject in center of frame.
Center focus area is used.

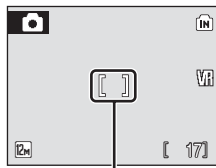

Focus area

Focus Lock

To focus on an off-center subject when [Center] is selected for [AF area mode], use focus lock as described below.

- 1 Position the subject in the center of the frame.
- 2 Press the shutter-release button halfway.
 - Confirm that the focus indicator (AF ●) is green.
- 3 Continue holding down the shutter-release button halfway and recompose the picture.
 - Be sure that the distance between the camera and the subject does not change.
- 4 Press the shutter-release button the rest of the way down to shoot.

**More Information**

See "Autofocus" (25) for more information.

Shooting with Face Priority

When [Face priority] is selected for [AF area mode], or the [Portrait] scene mode or [Night portrait] scene mode is selected during shooting, the face-priority function will be applied.

The camera automatically detects and focuses on a face looking toward the camera.

1 Frame the picture.

When the camera detects a face, the focus area containing the face will be displayed with a yellow double border.

When the camera detects more than one face, the closest face is framed by a double border and the others by single borders. Up to 12 faces can be detected.

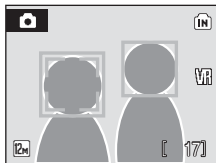

2 Press the shutter-release button halfway.

The camera focuses on the face framed by the double border. The double border will glow green and focus will be locked.

When the double border blinks, the camera is unable to focus. Press the shutter-release button halfway again to focus.

Press the shutter-release button all the way down to shoot.

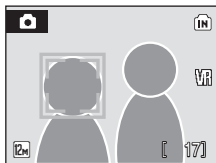

✓ Face-Priority

- When [Face priority] is selected for [AF area mode], the setting will automatically switch to [Auto] if no face is recognized when the shutter-release button is pressed halfway.
- If no face is recognized when the shutter-release button is pressed halfway in [Portrait] or [Night portrait] scene mode, the camera will focus on the subject in the center focus area.
- The camera may be unable to detect faces in the following situations:
 - When faces are partially hidden by sunglasses or other obstructions
 - When faces take up too much or too little of the frame
 - When the subject is not looking directly at the camera
- The camera's ability to detect faces depends on a variety of factors, including whether or not the subject is facing the camera.
- In some rare cases shooting subjects with which autofocus may not perform as expected (ⓘ 25), the subject may not be in focus despite the fact that the double border glows green. Should this occur, switch to  (auto) mode and set [AF area mode] to [Manual] or [Center], refocus on another subject positioned at the same distance from the camera as the actual portrait subject, and use focus lock described below.
- When pictures in which a face was detected during shooting are played back, the pictures will be automatically rotated for playback display, according to the orientation of the face detected.

Distortion Control

Specify whether or not the distortion is corrected. Enabling distortion control reduces the size of the frame.



On

Distortion at frame peripheries is corrected.



Off (default setting)

No distortion correction performed.

Restrictions on Camera Settings

Restrictions apply to the following settings in  (auto) and high-sensitivity shooting modes.

Flash mode

Flash mode is disabled () when [Continuous], [BSS], or [Multi-shot 16] is selected for [Continuous].





Applied setting is restored when [Single] or [Intvl timer shooting] is selected for [Continuous].

Self-timer

If self-timer is on, only one picture will be shot when shutter is released, regardless of settings chosen for [Continuous].

Applied [Continuous] settings are restored when picture is shot or self-timer is turned off.

ISO sensitivity

When [ISO sensitivity] is set to [3200], [Image mode] cannot be set to  (4,000 × 3,000),  (4,000 × 3,000),  (3,264 × 2,448), and  (3,968 × 2,232).

At these image mode settings, selecting [3200] for [ISO sensitivity] automatically switches the [Image mode] setting to  (2,592 × 1,944). When any option other than [3200] is next selected for [ISO sensitivity], the original image mode setting is restored.

At an [ISO sensitivity] setting of [3200], the [Multi-shot 16] option of the continuous shooting mode is not available. At a [Continuous] setting of [Multi-shot 16], selecting [3200] for [ISO sensitivity] switches the [Continuous] setting to [Single]. The [Continuous] setting does not change even when [ISO sensitivity] is set to options other than [3200].

Continuous

Selecting [Multi-shot 16] for [Continuous] changes image mode setting to [5M Normal (2592)].

If [Continuous] mode is restored to options other than [Multi-shot 16], the image mode setting will also be restored.

White balance

White balance is automatically set to [Auto] and cannot be adjusted when [Black-and-white], [Sepia] or [Cyanotype] is selected for [Color options].















Applied white balance setting is restored when [Standard color] or [Vivid color] is selected.

Distortion control

When [Distortion control] is set to [On], [Continuous] is automatically set to [Single]. Even when the [Distortion control] option is disabled, the [Continuous] setting does not change.

Playback Options: The Playback Menu

The playback menu contains the following options.

 D-Lighting  47
Enhances brightness and contrast in dark portions of pictures.
 Print set  78
Select pictures to print and the number of copies for each.
 Slide show  97
View pictures stored in the internal memory or on a memory card in an automatic slide show.
 Delete  98
Delete all or selected pictures.
 Protect  98
Protect selected pictures from accidental deletion.
 Small pic.  49
Create a small copy of the current picture.
 Copy  99
Copy files between memory card and internal memory.

Displaying the Playback Menu

Display the playback menu by pressing  and pressing **MENU**.

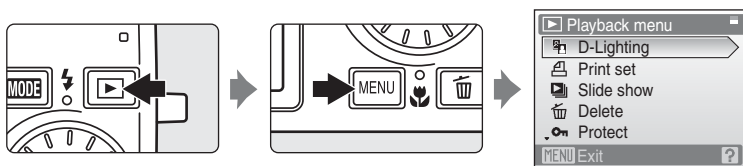

- Use the rotary multi selector to choose and apply settings ( 9).
- To exit the playback menu, press **MENU**.

Selecting Multiple Pictures

The screen shown at right will be displayed in the menus (shown below) when choosing pictures.

- **Playback menu:** Print set (, 78), Delete (, 98), Protect (, 98), Copy (, 99)
- **Setup menu:** Welcome screen (, 102)

Follow the procedure described below to choose the pictures.

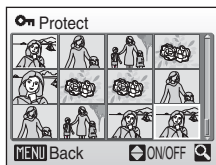

- 1 Rotate the rotary multi selector or press ◀ or ▶ to choose the desired picture.

Only one picture can be selected for [Welcome screen]. Proceed to step 3.

Press **T** () to switch to full-frame playback.

Press **W** () to switch back to thumbnail display.

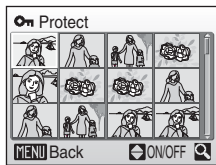

- 2 Press ▲ or ▼ to select [ON] or [OFF] (or the number of copies).

When [ON] is selected, a check mark (✔) is displayed in the top left corner of the current picture. Repeat steps 1 and 2 to select additional pictures.

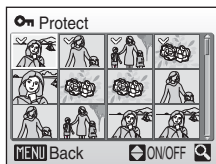

- 3 Press **OK**.

The setting is enabled.

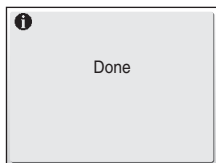

Slide Show

Play back pictures, stored in the internal memory or on a memory card, one by one in an automated “slide show.”

1 Use the rotary multi selector to choose [Start] and press **OK**.

To change the interval between pictures, choose [Frame intvl], select the desired interval time, and press **OK** before choosing [Start].

To repeat the slide show automatically, enable [Loop] and press **OK** before choosing [Start]. The check mark (✓) will be added to the loop option when enabled.

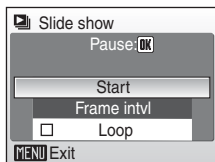

2 The slide show begins.

While the slide show is in progress, the following operations can be performed:

- Use the rotary multi selector to switch pictures. Continue rotating in either direction to fast forward (clockwise) or rewind (counterclockwise).
- Press **OK** to pause the slide show.



3 Choose [End] or [Restart].

When the slide show ends or is paused, choose [End] and press **OK** to return to the playback menu, or choose [Restart] to play the slide show again.

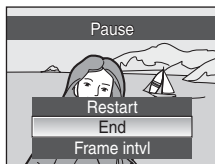

Notes on Slide Show

- Only the first frame of movies (61) included in slide shows is displayed.
- Even if [Loop] is selected, the monitor will turn off automatically if no operations are performed for 30 minutes. The camera will turn off automatically if no operations are performed for another three minutes.

Delete

Delete selected pictures or all pictures.

Erase selected images

Delete selected pictures ( 96).

Erase all images

Delete all pictures.





Notes on Deletion

- Once deleted, pictures cannot be recovered. Transfer important images to a computer before deletion.
- Pictures marked with the  icon are protected and cannot be deleted.

Protect

Protect selected pictures from accidental deletion (Selecting Multiple Pictures →  96).

Note, however, that formatting the camera's internal memory or the memory card will permanently erase protected files ( 111).

Protected pictures are recognized by the  icon ( 7) in full-frame playback mode and the erase selected images screen, and by the  icon ( 43) in four-picture or nine-picture thumbnail playback mode.

Copy

Copy pictures between the internal memory and a memory card.

- 1 Select an option from the copy screen using the rotary multi selector and press **OK**.

: Copy pictures from internal memory to memory card.

: Copy pictures from memory card to internal memory.

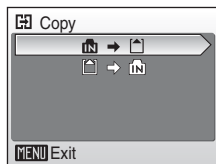



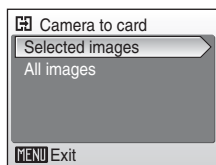

- 2 Select a copy option and press **OK**.

[Selected images]: Copy pictures selected from the picture selection screen ( 96).

[All images]: Copy all pictures.



Notes on Copying Pictures

- JPEG-, AVI-, and WAV-format images can be copied. Images recorded in any other format cannot be copied.
- If voice memos ( 50) are attached to pictures selected for copying, voice memos are copied with the pictures.
- Sound files recorded in voice recording mode ( 62) can be copied using the [Copy sound files] option ( 66) in audio playback mode.
- Pictures recorded with another make of camera or that have been modified on a computer cannot be copied.
- Edited copies have the same protection marking ( 98) as the original, but are not marked for printing ( 78).

[Memory contains no images.] Message































If there are no pictures stored on the memory card when playback mode is applied, the message [Memory contains no images.] will be displayed. Press **MENU** to display the copy option screen, and copy the pictures stored in the camera's internal memory to the memory card.

More Information

See "Image/Sound File and Folder Names" ( 116) for more information.

Basic Camera Setup: The Setup Menu

The setup menu contains the following options.

	Menu	 101
	Choose how menus are displayed.	
	Welcome screen	 102
	Select screen displayed when camera is turned on.	
	Date	 103
	Set camera clock and choose home and destination time zones.	
	Monitor settings	 106
	Adjust monitor brightness and choose display style.	
	Date imprint	 107
	Imprint date or date counter on pictures.	
	Vibration reduction	 109
	Enable vibration reduction for shooting still pictures.	
	AF assist	 109
	Enable or disable AF-assist illumination.	
	Digital zoom	 110
	Enable or disable digital zoom.	
	Sound settings	 110
	Adjust sound settings.	
	Auto off	 111
	Set time before camera enters standby mode.	
	Format memory/Format card	 111
	Format internal memory or memory card.	
	Language	 112
	Choose the language used for camera monitor display.	
	Video mode	 112
	Adjust settings necessary for connection to television.	
	Reset all	 112
	Restore camera settings to default values.	
	Firmware version	 114
	Display camera firmware version.	

Displaying the Setup Menu

First, display the playback-mode or shooting-mode selection menu by pressing **MODE**. Then select  (use the rotary multi selector), and press **OK**.

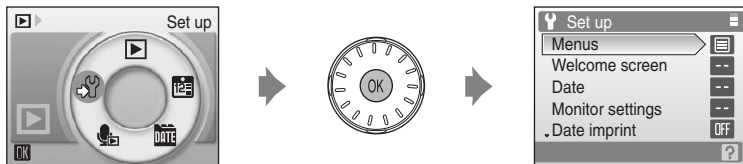

- Use the rotary multi selector to choose and apply settings ( 9).
- To exit the setup menu, press **MODE**.

MENU Menus

Select a format for menu display.

Text (default setting)

Menus are displayed in list format.

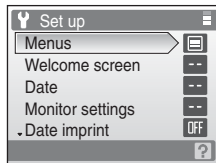

Icons

All menu items can be displayed in a single page.

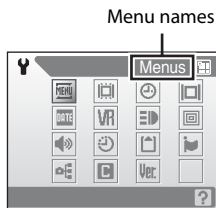

Welcome Screen

You can select the welcome screen to be displayed when the camera is turned on.

Disable welcome (default setting)

Welcome screen is not displayed.





COOLPIX

Displays a welcome screen.

Select an image

Select a picture in the internal memory or on the memory card for the welcome screen. Choose a picture in the picture selection screen and press .

As the selected image is stored in the camera, the image will appear in the welcome screen even if the original picture is deleted.

Pictures shot at an [Image mode] setting () 82) of  (3,968 × 2,232), and copies created at a image mode setting of 160 × 120 using the crop () 48) or small picture () 49) function, cannot be selected.

Date



Set the camera clock and choose home and travel destination time zones.

Date

Set camera clock to current date and time.

See step 6 and 7 of the section, "Setting Display Language, Date and Time" ( 17) for more information.

Time zone

 (home time zone) can be specified and daylight saving enabled or disabled from [Time zone] options. When  (destination time zone) is selected, the time difference ( 105) is automatically calculated and the date and time in the selected region are recorded. Useful when travelling.

Setting Travel Destination Time Zone

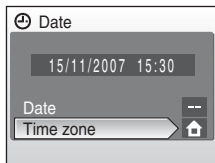

- 1 Use the rotary multi selector to choose [Time zone] and press .

The time zone menu is displayed.



- 2 Choose  and press .

The date and time displayed on the monitor changes according to the region currently selected.

If daylight saving time is in effect, use the rotary multi selector to choose [Daylight saving] and press , and then press . The time is automatically advanced one hour.

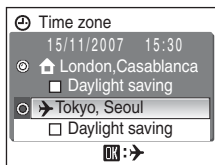

3 Press **▶**.

The new city time zone menu is displayed.

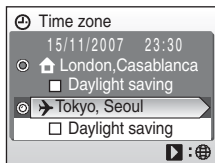

4 Choose the travel destination time zone and press **OK**.

The setting is enabled.

While the travel destination time zone is selected, the **▶** icon will be displayed in the monitor when the camera is in shooting mode.

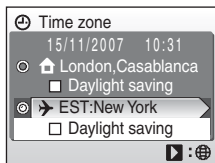
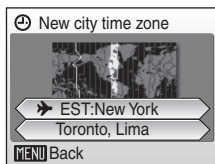

✔ The Clock Battery

The clock battery charges when the main battery is installed or an AC adapter (available separately from Nikon) is connected, and can provide several days of backup power after about ten hours of charging.

📍 **Home Time Zone**

- To switch to the home time zone, choose **🏠** in step 2.
- To change the home time zone, choose **🏠** in step 2 and perform steps 3 and 4, to set the home time zone.

📅 **Daylight Saving Time**

- If date and time are set when daylight saving time is not in effect: Turn [Daylight saving] on (**✔**) when daylight saving time begins, to automatically advance the camera's clock one hour.
- If date and time are set with [Daylight saving] turned on (**✔**) when daylight saving time is in effect: Turn [Daylight saving] off when daylight saving time ends, to automatically set the camera's clock back one hour.

 **Time Zones**  17)

The camera supports the time zones listed below. For time differences not listed below, set the camera clock to local time  16, 103).

GMT +/-	Location	GMT +/-	Location
-11	Midway, Samoa	+1	Madrid, Paris, Berlin
-10	Hawaii, Tahiti	+2	Athens, Helsinki
-9	Alaska, Anchorage	+3	Moscow, Nairobi
-8	PST (PDT): Los Angeles, Seattle, Vancouver	+4	Abu Dhabi, Dubai
-7	MST (MDT): Denver, Phoenix, La Paz	+5	Islamabad, Karachi
-6	CST (CDT): Chicago, Houston, Mexico City	+5.5	New Delhi
-5	EST (EDT): New York, Toronto, Lima	+6	Colombo, Dhaka
-4	Caracas, Manaus	+7	Bangkok, Jakarta
-3	Buenos Aires, São Paulo	+8	Beijing, Hong Kong, Singapore
-2	Fernando de Noronha	+9	Tokyo, Seoul
-1	Azores	+10	Sydney, Guam
±0	London, Casablanca	+11	New Caledonia
		+12	Auckland, Fiji

Monitor Settings

Choose whether or not to display information in the monitor, and set the monitor brightness.

Photo info

Choose information displayed in monitor during shooting and playback mode.







Brightness

Choose from five settings for monitor brightness. The default setting is [3].

Photo Info

The following display options are available.

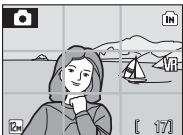
See "The Monitor" (📷 6) for information on indicators in the monitor.

	Shooting mode	Playback mode
Show info		
Auto info (default setting)	The current settings or operation guide is displayed for five seconds, as in [Show info] above. After five seconds, display will be the same as [Hide info].	
Hide info		
Framing grid	 <p>In 📷 (auto) mode or high-sensitivity shooting mode, a framing grid is displayed to help frame pictures; other current settings or operation guide is displayed for five seconds, as in [Auto info] above.</p> <p>In Face Priority and other shooting modes, the current settings or operation guide is displayed, as in [Auto info] above.</p>	 <p>The current settings or operation guide is displayed, as in [Auto info] above.</p>

DATE Date Imprint

Date and time of recording can be imprinted on pictures. This information can be printed even from printers that do not support printing of date and time (📷 79).

Off (default setting)

Date and time are not imprinted on pictures.

Date

Date is imprinted on the bottom right corner of pictures shot while this option is in effect.

Date and time

Date and time are imprinted on the bottom right corner of pictures shot while this option is in effect.

Date counter

Time stamp shows number of days between date of recording and selected date.

At settings other than [Off], the icon for the current setting is displayed in the monitor (📷 6).

✓ Date Imprint

- Imprinted dates form a permanent part of image data and cannot be deleted.
- Dates imprinted at an image mode setting (📷 82) of [TV screen (640)] may be difficult to read. Choose [PC screen (1024)] or larger when using date imprint.
- The date is recorded using the format selected in the setup menu's [Date] item (📷 16, 103).
- Date cannot be imprinted on pictures shot in certain modes (📷 124).

📎 Date Imprint and Print Set

When printing from DPOF-compatible printers which support printing of shooting date and photo information, the date and information can be printed on pictures without date and time imprinted on them, using options in the [Print set] menu (📷 75).

Date Counter

Pictures shot while this option is in effect are imprinted with the number of days remaining until, or the number of days elapsed since a specified date. Use it to track the growth of a child or count down the days until a birthday or wedding.

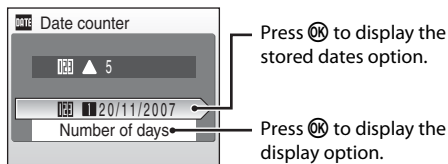

Stored dates

Up to three dates can be stored. To set, choose an option, press the rotary multi selector ►, enter a [Date] (ⓧ 17, step 6), and press OK. To select a different date, choose an option and press OK.

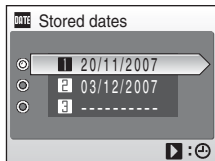

Display options

Choose [Number of days], [Years and days], or [Yrs, mnths, days] and press OK.

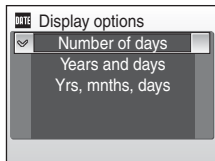

Sample date counter time stamps are shown below.



Two days remaining



Two days elapsed

Vibration Reduction

Enable or disable vibration reduction for shooting still pictures.

Vibration reduction effectively corrects blur, caused by slight hand movement known as camera shake, that commonly occurs when shooting with zoom applied or at slow shutter speeds. Vibration reduction can be used in all shooting modes.

On (default setting)

Vibration reduction is enabled when shooting still pictures. Camera detects and factors out panning movements when reducing camera shake. When camera is panned horizontally, for example, vibration reduction reduces only vertical shake. If camera is panned vertically, vibration reduction affects only horizontal shake.

Off

Vibration reduction is not enabled.

When vibration reduction is enabled, the current setting is displayed in the monitor during shooting (when [Off] is selected, an icon for the current setting is not displayed in the monitor)  6).

Notes on Vibration Reduction

- Vibration reduction may take a few seconds to activate after the power is turned on, or the camera enters shooting mode from playback mode. Wait until the display stabilizes before shooting.
- Due to characteristics of the vibration reduction function, images displayed in the camera's monitor immediately after shooting may appear blurry.
- Turn vibration reduction [Off] when using a tripod to stabilize the camera during shooting.
- Vibration reduction may be unable to completely eliminate the effects of camera shake in some situations.
- [VR] stands for vibration reduction.

Using Electronic VR with Movies

To reduce the effects of camera shake when recording movies, enable [Electronic VR]  58) from the movie menu  56).

AF Assist

Enable or disable AF-assist illumination.

Auto (default setting)

AF-assist illumination will be used to assist the focus operation when the subject is poorly lit. Note that for some scene modes, AF-assist illumination turns off automatically.

Off

Disable this function. The camera may be unable to focus if lighting is poor.

Digital Zoom

Enable or disable digital zoom.



On (default setting)

When the camera is zoomed in to the maximum magnification, holding down **T** (**Q**) triggers digital zoom.

Off

Digital Zoom will not be activated. (Except when shooting a movie).

Notes on Digital Zoom

- When digital zoom is in effect, [AF area mode] is set to [Center] ( 90).
- Digital zoom is not available in the following situations.
 - When [ Portrait] or [ Night portrait] is selected in scene mode.
 - When [Multi-shot 16] is selected for [Continuous].
 - Before movie recording begins (however, digital zoom of up to 2× can be applied while movies, other than time lapse and stop motion movies, are being recorded).

Sound Settings

Adjust the following sound settings.

Button sound

Turn button sound [On] or [Off].

When [On] (default setting) is selected, a beep will sound once when operations are completed successfully, twice when focus has been locked, and three times when an error is detected. The start-up sound will also play when the camera is turned on.

Shutter sound

Choose shutter sound from [On] (default setting) or [Off].

Auto Off

If no operations are performed for the selected length of time, the monitor will turn off and the camera will enter standby mode ( 21) to reduce the drain on the battery. The power-on lamp will blink in standby mode. If no operations are performed for about another three minutes, the camera will turn off automatically. Choose the time allowed to elapse before the camera enters standby mode. The time options are [30s], [1m] (default setting), [5m], or [30m].

Notes on Auto Off

Regardless of the option selected, the monitor will remain on for three minutes when menus are displayed, or for 30 minutes during continuous playback for slide shows or when an AC adapter (available separately from Nikon) is connected.

Format Memory/ Format Card

Use this option to format the internal memory or a memory card.

Formatting the Internal Memory

To format the internal memory, remove the memory card from the camera.

The [Format memory] option appears in the setup menu.

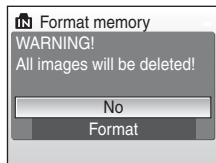

Formatting a Memory Card

When the memory card is inserted in the camera, the [Format card] option appears in the setup menu.

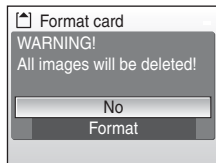

Formatting Internal Memory and Memory Cards

- Formatting the internal memory or memory cards permanently deletes all data. Be sure to transfer important pictures to a computer before formatting.
- Do not turn the camera off, disconnect the AC adapter, or open the battery-chamber/memory card cover during formatting.
- The first time you insert the memory cards used in other devices into the COOLPIX S700, be sure to format them using this camera.

Language

Choose one of 23 languages for display of camera menus and messages.

Čeština	Czech
Dansk	Danish
Deutsch	German
English	(default setting)
Español	Spanish
Ελληνικά	Greek
Français	French
Indonesia	Indonesian
Italiano	Italian
Magyar	Hungarian
Nederlands	Dutch
Norsk	Norwegian

Polski	Polish
Português	Portuguese
Русский	Russian
Suomi	Finnish
Svenska	Swedish
Türkçe	Turkish
中文简体	Simplified Chinese
中文繁體	Traditional Chinese
日本語	Japanese
한글	Korean
ภาษาไทย	Thai

Video Mode

Adjust settings for connection to a television. Choose from [NTSC] and [PAL].

Reset All

When [Reset] is selected, the camera's settings will be restored to their default values.

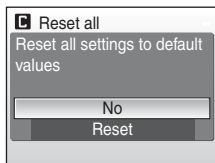

Pop-up Menu

Option	Default value
Flash mode (📷 28)	Auto
Self-timer (📷 30)	Off
Macro mode (📷 31)	Off
Exposure compensation (📷 32)	0.0

Scene Mode

Option	Default value
Scene menu (📷 34)	Portrait

Movie Menu

Option	Default value
Movie options (📷 56)	TV movie 640★
Set interval time for Time-lapse movie (📷 59)	30s
Playback speed for Stop-motion movie (📷 60)	5 fps
Auto-focus mode (📷 58)	Single AF
Electronic VR (📷 58)	Off

Shooting Menu

Option	Default value
Image mode (📷 82)	📷 Normal (4000)
White balance (📷 84)	Auto
Continuous (📷 86)	Single
Intvl timer shooting (📷 87)	30s
ISO sensitivity (📷 88)	Auto
Color options (📷 89)	Standard color
AF area mode (📷 90)	Face priority
Distortion control (📷 93)	Off

Setup Menu

Option	Default value
Menus (M 101)	Text
Welcome screen (M 102)	Disable welcome
Photo info (M 106)	Auto info
Brightness (M 106)	3
Date imprint (M 107)	Off
Vibration reduction (M 109)	On
AF assist (M 109)	Auto
Digital zoom (M 110)	On
Button sound (M 110)	On
Shutter sound (M 110)	On
Auto off (M 111)	1m

Others

Option	Default value
Paper size (M 74, 75)	Default
Slide show (M 97)	3s

- Choosing [Reset all] also clears the current file number (M 116) from the memory. Numbering will continue from the lowest number available. To reset file numbering to "0001", delete all pictures (M 98) before selecting [Reset all].
- The following settings in the menus will remain unaffected even if [Reset all] is performed.

Shooting menu: preset white balance value measured using [Preset manual] (M 85)

Setup menu: [Date] (M 103), [Date counter] (M 108), [Language] (M 112), and [Video mode] (M 112)

Ver. Firmware Version

View the current camera firmware version.



Firmware version

Optional Accessories

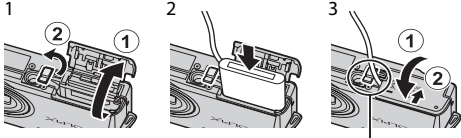
Rechargeable battery	Rechargeable Li-ion Battery EN-EL10
Battery charger	Battery Charger MH-63
AC adapter	<p>AC Adapter EH-62D</p> <p><How to connect EH-62D></p>  <p>Ensure that the power connector cord passes through the opening before closing the battery-chamber/memory card slot cover. Failure to observe this precaution could cause damage to the battery-chamber/memory card slot cover.</p>
Audio video/USB cable	Audio Video/USB Cable UC-E12

Approved Memory Cards

The following memory cards have been tested and approved for use in the COOLPIX S700.

SanDisk	<p>128 MB, 256 MB, 512 MB, 1 GB, 2 GB¹, 4 GB^{1,2}</p> <p>High-speed, 10-MB/s cards: 512 MB, 1 GB, 2 GB¹, 4 GB^{1,2}</p> <p>High-speed, 20-MB/s cards: 1 GB, 2 GB¹</p>
Toshiba	<p>128 MB, 256 MB, 512 MB, 1 GB, 2 GB¹, 4 GB^{1,2}</p> <p>High-speed, 10-MB/s cards: 256 MB, 512 MB, 1 GB</p> <p>High-speed, 20-MB/s cards: 512 MB, 1 GB, 2 GB¹</p>
Panasonic	<p>128 MB, 256 MB, 512 MB, 1 GB, 2 GB¹, 4 GB^{1,2}</p> <p>High-speed, 10-MB/s cards: 4 GB^{1,2}</p> <p>High-speed, 20-MB/s cards: 512 MB, 1 GB, 2 GB¹, 4 GB^{1,2}</p>

¹ If the memory card will be used with a card reader or similar device, the device must support memory card specifications.

²  SDHC-compliant.

Other cards have not been tested. For more details on the memory cards listed above, please contact the manufacturer.

Image/Sound File and Folder Names

Pictures, movies, voice memos and voice recordings are assigned file names as follows.

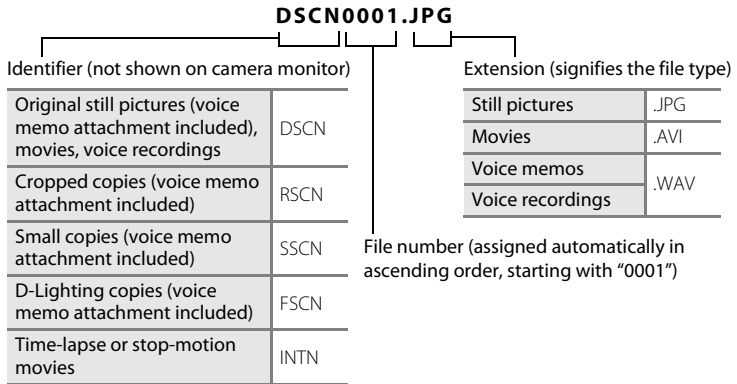

- Files are stored in folders named with a folder number followed by a five-character identifier: "P_" plus a three-digit sequence number for pictures shot using panorama assist (e.g. "101P_001"; 40), "INTVL" for interval timer photography (e.g. "101INTVL"; 87), "SOUND" for voice recordings (e.g. "101SOUND"; 62), and "NIKON" for all other pictures (e.g. "100NIKON"). When the number of files within a folder reaches 9999, a new folder will be created. File numbers will be assigned automatically starting with "0001."
- Files copied using [Copy] > [Selected images] or [Copy sound files] > [Selected files] are copied to the current folder, where they are assigned new file numbers in ascending order starting from the largest file number in memory. [Copy] > [All images] and [Copy sound files] > [Copy all files] copy all folders from the source medium; file names do not change but new folder numbers are assigned in ascending order, starting from the largest folder number on the destination medium (66, 99).
- A single folder can hold up to 200 pictures; if the current folder already contains 200 pictures, a new folder, named by adding one to the current folder name, will be created the next time a picture is shot. If the current folder is numbered 999 and contains 200 pictures, or a picture is numbered 9999, no further pictures can be shot until the internal memory or memory card is formatted (111), or a new memory card is inserted.

Caring for the Camera

To ensure continued enjoyment of this Nikon product, observe the following precautions when using or storing the device:

Keep Dry

The device will be damaged if immersed in water or subjected to high humidity.

Do Not Drop

The product may malfunction if subjected to strong shock or vibration.

Handle the Lens and all Moving Parts with Care

Do not apply force to the lens, lens cover, monitor, memory card slot or battery chamber. These parts are easily damaged. Applying force to the lens cover could result in camera malfunction or damage to the lens. Should the monitor break, care should be taken to avoid injury caused by broken glass and to prevent the liquid crystal from the display touching the skin or entering the eyes or mouth.

Do Not Point the Lens at Strong Light Sources for Extended Periods

Avoid pointing the lens at the sun or other strong light sources for extended periods when using or storing the camera. Intense light may cause deterioration of the CCD image sensor, producing a white blur effect in photographs.

Keep Away from Strong Magnetic Fields

Do not use or store this device in the vicinity of equipment that generates strong electromagnetic radiation or magnetic fields. Strong static charges or the magnetic fields produced by equipment such as radio transmitters could interfere with the monitor, damage data stored on the memory card, or affect the product's internal circuitry.

Avoid Sudden Changes in Temperature

Sudden changes in temperature, such as when entering or leaving a heated building on a cold day, can cause condensation to form inside the device. To prevent condensation, place the device in a carrying case or a plastic bag before exposing it to sudden changes in temperature.

Turn the Product Off Before Removing or Disconnecting the Power Source

Do not remove the battery while the product is on, or while images are being recorded or deleted. Forcibly cutting power in these circumstances could result in loss of data or in damage to product memory or internal circuitry.

The Self-timer Lamp/AF-assist Illuminator LED

The light-emitting diode (LED;  4, 30, 109) used in the self-timer lamp/AF-assist illuminator conforms to the following IEC standard:

CLASS 1 LED PRODUCT

IEC60825-1 Edition 1,2-2001

The Battery

- Check the battery level when taking the camera out, and charge the battery if necessary. Do not continue charging once the battery is fully charged, as this will result in reduced battery performance. If possible, carry a fully-charged spare battery when shooting on important occasions.
- Do not use the battery at ambient temperatures below 0 °C (32 °F) or above 40 °C (104 °F). During charging, the temperature should be in the vicinity of 5 to 35 °C (41 to 95 °F). Note that the battery may become hot during use; wait for the battery to cool before charging. Failure to observe these precautions could damage the battery, impair its performance or prevent it from charging normally.
- On cold days, the capacity of batteries tends to decrease. Be sure that the battery is fully charged before heading outside to shoot in cold weather. Keep spare batteries in a warm place and exchange as necessary. Once warmed, a cold battery may recover some of its charge.
- Dirt on the battery terminals can prevent the camera from functioning.
- When the battery is not in use, remove it from the camera or battery charger and return it to the battery case. The camera and battery charger draw minute amounts of current even when off; if left in place, the battery could be drained to the point that it no longer functions. Turning the camera on or off while the battery is exhausted can result in reduced battery life. If the battery will not be used for an extended period, store it in a cool (15 to 25 °C / 59 to 77 °F), dry place. Recharge it at least once a year and run it flat before returning it to storage.
- Replace the battery when it no longer holds a charge. Used batteries are a valuable resource. Please recycle used batteries in accordance with local regulations.

Cleaning

Lens	Avoid touching glass parts with your fingers. Remove dust or lint with a blower (typically a small device with a rubber bulb attached to one end that is pumped to produce a stream of air out the other end). To remove fingerprints or other stains that cannot be removed with a blower, wipe the lens with a soft cloth, using a spiral motion that starts at the center of the lens and working toward the edges. If this fails, clean the lens using a cloth lightly dampened with commercial lens cleaner.
Monitor	Remove dust or lint with a blower. To remove fingerprints and other stains, clean the monitor with a soft, dry cloth, being careful not to apply pressure.
Body	Use a blower to remove dust, dirt or sand, then wipe gently with a soft, dry cloth. After using the camera at the beach or seaside, wipe off any sand or salt with a dry cloth lightly dampened with fresh water, then dry thoroughly. Note that foreign matter inside the camera could cause damage not covered by the warranty.

Do not use alcohol, thinner, or other volatile chemicals.

Storage

Turn the camera off when not in use. Check that the power-on lamp is off before putting the camera away. Remove the battery if the camera will not be used for an extended period. Do not store the camera with naphtha or camphor moth balls, or in any of the following locations:

- Next to equipment that produces strong electromagnetic fields, such as televisions or radios
- Exposed to temperatures below -10°C (14°F) or above 50°C (122°F)
- Poorly ventilated or subject to humidities of over 60 %













To prevent mold or mildew, take the camera out of storage at least once a month. Turn the camera on and release the shutter a few times before putting the camera away again.









Notes on the Monitor

- The monitor may contain a few pixels that are always lit or that do not light. This is a characteristic common to all TFT LCD displays, and does not indicate a malfunction. Images recorded using the product will not be affected.
- When framing bright subjects, vertical comet-like streaks that whiten toward either end may appear in the display. This phenomenon, known as “smear,” does not appear in the final photograph and does not indicate a malfunction. Some smear may appear in movies.
- Images in the monitor may be difficult to see under bright lighting.
- The monitor is lit by an LED backlight. Should the monitor begin to dim or flicker, contact your Nikon-authorized service representative.

Error Messages















The following table lists the error messages and other warnings displayed in the monitor, as well as the solutions for dealing with them.

Display	Problem	Solution	
 (blinks)	Clock not set.	Set clock.	103
	Battery running low.	Prepare to charge or change battery.	12
 Warning! Battery exhausted.	Battery exhausted.	Charge or change battery.	12
 ● (● blinks red)	Camera cannot focus.	<ul style="list-style-type: none"> • Refocus. • Use focus lock. 	24, 25, 91
 Warning!! Please wait for the camera to finish recording. 	Camera cannot perform other operations until recording is complete.	Wait until message clears from display automatically when recording is complete.	25
 Memory card is write protected.	Write-protect switch is in "lock" position.	Slide write-protect switch to "write" position.	19
 This card cannot be used.	Error accessing memory card.	<ul style="list-style-type: none"> • Use approved card. • Check that connectors are clean. • Confirm that memory card is correctly inserted. 	115
 Warning! This card cannot be read.			18
 Card is not formatted. Format card? No Yes	Memory card has not been formatted for use in camera.	Choose [Yes] and press  to format card, or turn camera off and replace card.	19
 Out of memory.	Memory card is full.	<ul style="list-style-type: none"> • Choose smaller image size. • Delete pictures or sound files. • Insert new memory card. • Remove memory card and use internal memory. 	82 26, 61, 65 18 19

Display	Problem	Solution	
 Image cannot be saved.	Error occurred while recording picture.	Format internal memory or memory card.	111
	Camera has run out of file numbers.	<ul style="list-style-type: none"> • Insert new memory card. • Format internal memory or memory card. 	18 111
	Picture cannot be used for welcome screen.	Choose picture 320 × 240 pixels or larger, or picture shot at an image mode setting other than [16:9].	48, 49, 82
	Cannot copy picture.	Delete pictures from destination.	98
 Sound file cannot be saved.	Camera has run out of file numbers.	<ul style="list-style-type: none"> • Insert new memory card. • Format internal memory or memory card. 	18 111
 Image can not be modified.	Cannot edit selected picture.	Select picture that supports D-Lighting, crop, or small picture.	46
 Cannot record movie.	Time out error while recording movie.	Choose memory card with faster write speed.	115
 Memory contains no images.	<ul style="list-style-type: none"> • No pictures or sound file in the internal memory or memory card. 	–	–
 No sound file.	<ul style="list-style-type: none"> • Memory card does not contain pictures or sound file. 	To copy picture or sound file from internal memory to memory card, press MENU . The copy option screen or copy sound file screen will be displayed.	99, 66
 File contains no image data.	File not created with COOLPIX S700.	View file on computer or other device.	–
 This file cannot be played back.			

Error Messages

Display	Problem	Solution	
i All images are hidden.	Date and time are not set for pictures to be displayed in calendar mode or list by date mode.	–	–
i This image cannot be deleted.	Picture is protected.	Disable protection.	98
i New city is in the current time zone.	Destination in same time zone as home.	–	105
Lens error !	Lens error.	Turn camera off and then on again. If error persists, contact retailer or Nikon-authorized service representative.	20
! Communications error	Audio video/USB cable disconnected during transfer or printing.	If Nikon Transfer displays error, click [OK] to exit. Resume operation after turning camera off and reconnecting cable.	69, 73
System error !	Error has occurred in camera's internal circuitry.	Turn camera off, remove and reinsert battery, and turn camera on. If error persists, contact retailer or Nikon-authorized service representative.	14, 20





Display	Problem	Solution	
 Printer error. Check printer status.	Running out of ink or printer error.	Check printer. After checking the ink or solving the problem, select [Resume] and press  to resume printing*.	-
 Printer error: check paper	Specified size of paper is not loaded in printer.	Load the specified paper, select [Resume] and press  to resume printing*.	-
 Printer error: paper jam	Paper has jammed in the printer.	Eject the jammed paper, select [Resume] and press  to resume printing*.	-
 Printer error: out of paper	No paper is loaded in printer.	Load the specified paper, select [Resume] and press  to resume printing*.	-
 Printer error: check ink	Ink error.	Check ink, select [Resume] and press  to resume printing*.	-
 Printer error: out of ink	Ink cartridge is empty.	Replace ink, select [Resume] and press  to resume printing*.	-
 Printer error: file corrupt	An error caused by the image file has occurred.	Select [Cancel] and press  to cancel printing.	-

* See the documentation provided with your printer for further guidance and information.

Troubleshooting

If the camera fails to function as expected, check the list of common problems below before consulting your retailer or Nikon-authorized service representative. Refer to the page numbers in the right-most column for more information.



Display, Settings and Power Supply





Problem	Cause/Solution	
Monitor is blank	<ul style="list-style-type: none">• Camera is off.• Battery is exhausted.• Standby mode for saving power: press the shutter-release button halfway.• When flash lamp blinks red, wait until flash has charged.• Camera and computer are connected via audio/video USB cable.• Camera and TV are connected via audio/video USB cable.• Time lapse or interval timer photography in progress.	20 20 21, 25 29 69 67 –
Monitor is hard to read	<ul style="list-style-type: none">• Adjust monitor brightness.• Monitor is dirty. Clean monitor.• Monitor has dimmed to save power. Monitor brightens when controls are used.	106 119 21
Camera turns off without warning	<ul style="list-style-type: none">• Battery is low.• Camera has turned off automatically to save power.• Battery is cold.	20 111 118
Date and time of recording are not correct	<ul style="list-style-type: none">• Pictures recorded before clock was set, and “Date not set” indicator blinks during shooting, will have time stamp of “00/00/0000 00:00”; movies and voice recordings will be dated “01/09/2007 00:00.”• Check camera clock regularly against more accurate timepieces and reset as required.	16 103
No indicators displayed in monitor	[Hide info] is selected for [Photo info]. Select [Show info].	106
[Date imprint] not available	Camera clock has not been set.	16, 103
Date not appearing on pictures even when [Date imprint] is enabled	Date does not appear on movies or on pictures shot using  ,  ,  or when [Continuous] is set to [Continuous] or [BSS].	35, 38, 40, 55, 86
Camera settings reset	Backup battery is exhausted; all settings were restored to their default values.	104





Electronically Controlled Cameras

In extremely rare instances, unusual characters may appear in the monitor and the camera may stop functioning. In most cases, this phenomenon is caused by a strong external static charge. Turn the camera off, remove and replace the battery, then turn the camera on again. In the event of continued malfunction, contact your retailer or Nikon-authorized service representative. Note that disconnecting the power source as described above may result in the loss of any data not recorded to internal memory or the memory card at the time the problem occurred. Data already recorded will not be affected.

Shooting

Problem	Cause/Solution	
Camera does not shoot when shutter-release button is pressed.	• When camera is in playback mode, press  or the shutter-release button.	26
	• When menus are displayed, press MENU .	10
	• Battery is exhausted.	20
	• When flash lamp blinks, flash is charging.	29
Camera cannot focus.	• The intended subject is one with which autofocus does not perform well.	25
	• Set [AF assist] in the setup menu to [Auto].	109
	• Focus error. Turn camera off and then on again.	20
Pictures are blurred.	• Use flash.	28
	• Use high-sensitivity shooting mode.	33
	• Use vibration reduction.	109
	• Set [Continuous] to [BSS].	86
	• Use tripod and self-timer.	30
Bright specks appear in pictures shot with flash.	Flash is reflecting off particles in air. Turn flash off.	29
Flash does not fire.	• Flash is off.	28
	• Some scene modes that cannot turn on flash are selected.	34
	•  modes other than [Time-lapse movie] and [Stop-motion movie] are selected.	55
	• [Continuous], [BSS], or [Multi-shot 16] is selected for [Continuous].	86
Optical zoom cannot be used.	Optical zoom cannot be used while recording movies.	55

Problem	Cause/Solution	
Digital zoom cannot be used.	[Digital zoom] is set to [Off] in the setup menu. Digital zoom is not available in the following situations. <ul style="list-style-type: none"> • when [Portrait] or [Night portrait] is selected for scene mode. • when [Multi-shot 16] is selected for [Continuous]. • before movie recording begins. 	110 35, 36 86 55
[Image mode] not available.	<ul style="list-style-type: none"> • [Image mode] cannot be adjusted when [Multi-shot 16] is selected for [Continuous]. • [Image mode] cannot be set to [24 4000 × 3000], [24 4000 × 3000], [8M 3264 × 2448], and [16S 3968 × 2232] when [ISO sensitivity] is set to [3200]. 	86 88
No sound when shutter is released.	<ul style="list-style-type: none"> • [Off] is selected for [Sound settings] > [Shutter sound] in setup menu. • [Continuous], [BSS], or [Multi-shot 16] is selected for [Continuous] in shooting menu. •  ([Sports] scene mode) or  ([Museum] scene mode) is selected. •  mode is selected. 	110 86 35, 38 55
AF-assist illuminator does not light.	<ul style="list-style-type: none"> • [Off] is selected for AF assist option in camera setup menu. • AF-assist illuminator turns off automatically in some modes. 	109 35-40
Pictures appear smeared.	Lens is dirty. Clean lens.	119
Colors are unnatural.	White balance does not match light source.	84
Randomly spaced bright pixels ("noise") appear in image.	Shutter speed too slow. Noise can be reduced by: <ul style="list-style-type: none"> • Using flash • Specifying a lower ISO sensitivity setting • Using a scene mode which has noise reduction ability. 	28 88 35-40
Pictures are too dark (underexposed).	<ul style="list-style-type: none"> • Flash is off. • Flash window is blocked. • Subject is beyond flash range. • Adjust exposure compensation. • Apply high-sensitivity shooting mode, or raise the ISO sensitivity. • Subject is backlit. Select  ([Backlight] scene mode) or use fill flash. 	28 22 28 32 33, 88 28 39

Problem	Cause/Solution	
Pictures are too bright (overexposed).	Adjust exposure compensation.	32
Unexpected results when flash set to  (auto with red-eye reduction).	When  or "fill flash with slow sync and red-eye reduction" of the [Night portrait] scene mode is applied during shooting, In-Camera Red-Eye Fix may, in very rare cases, be applied to areas not affected by red-eye. Set a flash mode other than  when in a shooting mode other than the [Night portrait] scene mode during shooting.	28, 36
Camera does not shoot with [Multi-shot 16].	At an [ISO sensitivity] setting of [3200], the [Multi-shot 16] option is not available. When shooting with the [Multi-shot 16] option, select options other than [3200] for [ISO sensitivity] and select [Multi-shot 16] for [Continuous].	86, 88
The camera makes a sound when the shutter-release button is pressed halfway.	Pressing the shutter-release button halfway may activate vibration reduction. The sound of vibration reduction operation is sometimes noticeable.	109

Playback

Problem	Cause/Solution	
File cannot be played back.	<ul style="list-style-type: none"> File was overwritten or renamed by computer or other make of camera. Time-lapse, stop-motion, or interval timer photography in progress: pictures cannot be played back until recording is complete. 	–
Cannot zoom in on picture.	Playback zoom cannot be used with movies, small pictures, or pictures that have been cropped to below 320 × 240.	–
Cannot record or playback voice memo.	<ul style="list-style-type: none"> Voice memos cannot be appended to movies. Voice memos cannot be appended to pictures shot by other cameras, and voice memos recorded by other cameras cannot be played back. 	61 50

Problem	Cause/Solution	
Cannot use D-Lighting, crop, or small picture options.	<ul style="list-style-type: none"> • These options cannot be used with movies, and pictures shot when [16:9] is applied in the [Image mode] setting. • Select picture that supports D-Lighting, crop, or small picture. • Camera is unable to edit pictures recorded with other cameras. • Other cameras may be unable to playback or transfer pictures edited with this camera. 	61, 82 46 46
Pictures not displayed on television.	<ul style="list-style-type: none"> • Choose correct [Video mode]. • Memory card contains no pictures. Replace memory card. Remove memory card to playback pictures from internal memory. 	112 18
Nikon Transfer does not start when camera is connected.	<ul style="list-style-type: none"> • Camera is off. • Battery is exhausted. • Audio video/USB cable is not correctly connected. • Camera is not recognized by the computer. • Computer is not set to launch Nikon Transfer automatically. • If your computer is running Windows 2000 Professional, camera cannot be connected to the computer. <p>See the help information contained in Nikon Transfer.</p>	20 20 69 – – 70
Pictures to be printed are not displayed.	Memory card contains no pictures. Replace memory card. Remove memory card to print pictures from internal memory.	18
Cannot select paper size with camera.	Paper size cannot be selected from the camera if the printer does not support the page sizes used by the camera, or the printer automatically selects the page size. Use the printer to select page size.	74, 75

Specifications

Nikon COOLPIX S700 Digital Camera

Type	Compact digital camera
Effective pixels	12.1 million
Image sensor	1/1.72-in. CCD; total pixels: approx. 12.43 million
Lens	3x Zoom-Nikkor lens
Focal length	7.9-23.7 mm (equivalent with 35 mm [135] format picture angle: 37-111 mm)
f/-number	f/2.8-5.4
Construction	7 elements in 5 groups
Digital zoom	Up to 4x (equivalent with 35 mm [135] format picture angle: approx. 444 mm)
Vibration reduction	Image-sensor shift (still pictures) Electronic (movies)
Autofocus (AF)	Contrast-detect AF
Focus range (from lens)	<ul style="list-style-type: none">• 50 cm (1 ft. 7.6 in.) to ∞• Macro mode: 6 cm (2.4 in.) to ∞(wide zoom position)
Focus-area selection	Auto (9-area automatic selection), center, manual with 99 focus areas, face priority
AF-assist illumination	Class 1 LED product (IEC 60825-1 Edition 1.2 ²⁰⁰¹); max. output: 1700 μW
Monitor	2.7 in., 230,000-dot, wide viewing angle TFT LCD with anti-reflection coating and 5-level brightness adjustment
Frame coverage (shooting mode)	Approx. 97 % horizontal and 97 % vertical
Frame coverage (playback mode)	Approx. 100 % horizontal and 100 % vertical
Storage	
Media	<ul style="list-style-type: none">• Internal memory (approx. 52 MB)• SD (Secure Digital) memory cards
File system	DCF, Exif 2.2, and DPOF compliant
File formats	Compressed: JPEG-baseline compliant Movies: AVI Sound files: WAV
Image size (pixels)	<ul style="list-style-type: none">• 4,000 × 3,000 [High (4000★)/Normal (4000)]• 3,264 × 2,448 [Normal (3264)]• 2,592 × 1,944 [Normal (2592)]• 2,048 × 1,536 [Normal (2048)]• 1,024 × 768 [PC screen (1024)]• 640 × 480 [TV screen (640)]• 3,968 × 2,232 [16:9]

Specifications

ISO sensitivity (Standard output sensitivity)	ISO 64, 100, 200, 400, 800, 1600, 2000, 3200, Auto (auto gain from ISO 64 to 1000)
Exposure	
Metering	256-segment matrix, center-weighted, spot (digital zoom)
Exposure control	Programmed auto exposure with exposure compensation (-2.0 to +2.0 EV in steps of 1/3 EV)
Range (ISO 100)	[W]: 0.4 to 17.8 EV [T]: 2.3 to 19.7 EV
Shutter	Mechanical and charge-coupled electronic shutter
Speed	1/2000-4 s
Aperture	Electronically-controlled ND filter selection
Range	2 steps (f/2.8 and f/8.0 [W])
Self-timer	Can be selected from 10 and 3 second duration
Built-in flash	
Range (approx.) (ISO sensitivity: [Auto])	[W]: 0.3 to 4.8 m (1 ft. to 15 ft. 8.9 in.) [T]: 0.3 to 2.4 m (1 ft. to 7 ft. 10.5 in.)
Flash control	Sensor flash system
Interface	USB
Data transfer protocol	MTP, PTP
Video output	Can be selected from NTSC and PAL
I/O terminal	Multi connector (supports ImageLink)
Supported languages	Chinese (Simplified and Traditional), Czech, Danish, Dutch, English, Finnish, French, German, Greek, Hungarian, Indonesian, Italian, Japanese, Korean, Polish, Portuguese, Norwegian, Russian, Spanish, Swedish, Thai, Turkish
Power sources	<ul style="list-style-type: none"> • One EN-EL10 Rechargeable Li-ion Battery (supplied) • AC Adapter EH-62D (available separately from Nikon)
Battery life*	Approx. 150 shots (EN-EL10)
Dimensions (W × H × D)	Approx. 89 × 54 × 23 mm (3.5 × 2.1 × 0.9 in.) (excluding projections)
Weight	Approx. 130 g (4.6 oz) (without battery and SD memory card)
Operating environment	
Temperature	0 to 40 °C (32 to 104 °F)
Humidity	Less than 85 % (no condensation)

* Based on Camera and Imaging Products Association (CIPA) standards for measuring the life of camera batteries. Measured at 23 °C (73 °F); zoom adjusted with each shot, flash fired with every other shot, image mode set to [L2] Normal (4000). Battery life may vary depending on shooting interval and length of time menus and images are displayed.

* Unless otherwise stated, all figures are for a camera with a fully-charged Rechargeable Li-ion Battery EN-EL10 operated at an ambient temperature of 25 °C (77 °F).

Rechargeable Li-ion Battery EN-EL10

Type	Rechargeable lithium-ion battery
Rated capacity	3.7 V DC, 740 mAh
Operating temperature	0 to 40 °C (32 to 104 °F)
Dimensions (W × H × D)	Approx. 31.5 × 39.5 × 6 mm (1.2 × 1.6 × 0.2 in.) (excluding projections)
Weight	Approx. 15 g (0.5 oz) (excluding battery case)

Battery Charger MH-63

Rated input	100-240 V AC, 50/60 Hz, 0.07-0.045 A
Rated capacity	7-10.8 VA
Rated output	4.2 V DC, 0.55 A
Battery	Rechargeable Li-ion Battery EN-EL10
Charging time	Approx. 100 minutes when battery is fully discharged
Operating temperature	0 to 40 °C (32 to 104 °F)
Dimensions (W × H × D)	Approx. 54 × 20 × 85 mm (2.1 × 0.8 × 3.3 in.) (excluding power cable)
Weight	Approx. 55 g (1.9 oz) (excluding power cable)

Dock Insert PV-17

Dimensions (W × H × D)	Approx. 135.5 × 17 × 63 mm (5.3 × 0.7 × 2.5 in.) (excluding projections)
Weight	Approx. 29 g (1.0 oz)

✓ Specifications

Nikon will not be held liable for any errors this manual may contain. The appearance of this product and its specifications are subject to change without notice.

Supported Standards

- **DCF:** Design Rule for Camera File System is a standard widely used in the digital camera industry to ensure compatibility among different makes of camera.
- **DPOF:** Digital Print Order Format is an industry-wide standard that allows pictures to be printed from print orders stored on the memory card.
- **Exif version 2.2:** This camera supports Exif (Exchangeable Image File Format for Digital Still Cameras) version 2.2, a standard that allows information stored with photographs to be used for optimal color reproduction when images are output from Exif-compliant printers.
- **PictBridge:** A standard developed cooperatively by the digital camera and printer industries, allowing photographs to be output directly to a printer without connecting the camera to a computer.
- **ImageLink:** The ImageLink standard allows pictures shot with a digital camera to be printed directly on a household printer, without using a computer. The camera can be connected directly to any ImageLink-compatible printer for picture printing.

Index

Symbols

 41

T (tele) 23

W (wide) 23

 Playback zoom 45, 48

 Thumbnail playback 43

 (apply selection) button 5, 9

 Audio playback mode 64

 Auto mode 20

 Calendar mode 51

 (delete) button 5, 26, 27, 50, 61, 65

 (exposure compensation) 32

 Flash mode 28

 Help 11

 High sensitivity mode 33

 List by date mode 52

 Macro mode 31

MENU button 5, 10

MODE (mode) button 5, 8

 Movie mode 55

 Playback mode 8

 Scene mode 34

 Self timer 30

 Setup mode 100

 (shooting/playback) button 5, 8, 26

VR Vibration reduction 21, 109

 Voice recording mode 62

A

AC adapter 115

AF area 24

AF area mode 90

AF-assist illumination 4, 25, 109

Audio playback mode 64

Audio video/USB cable 67, 68, 69, 73

Audio-in/Video-in jack 67

Auto flash 28

Auto focus 31, 58

Auto mode 20

Auto power off 111

Auto-focus mode 58

AVI 116

B

Backlight  39

Battery 12, 14, 104

Battery charger 12, 115

Battery latch 5, 14

Battery level 20

Battery-chamber 5

Battery-chamber/memory card slot cover
5, 14, 18

Beach/snow  36

Best Shot Selector 86

Black-and-white 89

Brightness 106

BSS 86

Built-in flash 4, 28

Built-in microphone 4, 50

Button sound 110

C

Calendar mode 51

Close-up  38

Cloudy 84

Color options 89

Compression ratio 82

Computer 68

Continuous 86

Copy  39

Copying pictures 99

Copying voice recordings 66

Crop 48

Cyanotype 89

D

Date 16, 103

Date counter 107, 108

Date imprint 107







Daylight 84

Daylight saving time 16, 104

Delete 98

Digital zoom 23, 110

Direct print 72

- Distortion control 93
- D-Lighting 46, 47
- Dock insert 80
- DPOF 132
- DPOF print 77
- DSCN 116
- Dusk/dawn  37
- E**
- Electronic VR 58
- EN-EL10 12, 14
- Exposure compensation 32
- Extension 116
- Eyelet for camera strap 4
- E**
- Face priority 90
- File names 116
- Fill flash 28
- Fireworks show  39
- Firmware version 114
- Flash 28, 29
- Flash lamp 5, 29
- Flash off 28
- Fluorescent 84
- Focus 24, 58, 90
- Focus lock 91
- Folder name 116
- Format 19, 111
- Format memory card 19, 111
- Formatting internal memory 111
- FSCN 116
- Full-time AF 58
- G**
- GMT 105
- H**
- Halfway 25
- High sensitivity mode 33
- I**
- Identifier 116
- Image mode 21, 34, 82
- Image size 82
- ImageLink-compatible printer 80
- Incandescent 84
- Indicator lamp 5
- Internal memory 18
- Intvl timer shooting 87
- ISO sensitivity 29, 33, 88
- J**
- JPG 116
- L**
- Language 112
- Lens 4, 119, 129
- Li-ion rechargeable battery 12, 14
- List by date mode 52
- M**
- Macro mode 31
- Making voice recordings 62
- Memory capacity 20
- Memory card 18, 115
- Memory card slot 5, 18
- Menus 101
- Monitor 5, 6, 119
- Monitor settings 106
- Move playback 61
- Movie menu 56
- Movie mode 55
- Movie settings 56
- Multi connector 5
- Multi-shot 16 86
- Museum  38
- N**
- Night landscape  37
- Night portrait  36
- Noise reduction 36, 37
- Number of exposures remaining 20, 83
- O**
- Optical zoom 23
- Optional accessories 115
- P**
- Panorama assist  40
- Paper size 74, 75

Party/indoor  36
 Photo info 106
 PictBridge 72, 132
 Playback 26, 27, 43, 44, 45
 Playback menu 95
 Playback mode 26
 Playback-mode selection menu 8
 Playing voice recordings 64
 Power 16, 20
 Power switch 4, 20
 Power-on lamp 4, 20
 Preset manual (White balance) 85
 Print 74, 75, 78
 Print set 78
 Print set (Date) 79
 Printer 72
 Protect 98

Q



Quick Playback Zoom 45

R

Rechargeable battery 115
 Rechargeable Li-ion battery 12, 14
 Recording movies 55
 Red-eye reduction 28, 29
 Replay mode 26, 27
 Reset all 112
 Rotary multi selector 5, 9
 RSCN 116

S

Scene mode 34, 35
 Self-timer 30
 Self-timer lamp 4, 30
 Sepia 89
 Setup menu 100
 Shooting 20, 22, 24
 Shooting menu 81
 Shooting-mode selection menu 8
 Shutter sound 110
 Shutter-release button 4, 24
 Single 86

Single AF 58
 Slideshow 97
 Slow sync 28
 Small picture 49
 Smaller size 56, 57
 Sound settings 110
 Speaker 4
 Sports  35
 SSCN 116
 Standard color 89
 Stop-motion 60
 Strap 11
 Sunset  37

T

Thumbnail
 playback 44
 wheel playback 44
 Thumbnail playback 43
 Time zone 16, 103, 105
 Time-lapse movies 59
 Tripod 5
 TV 67
 TV movie 56, 57

V

Vibration reduction (movies) 58
 Vibration reduction (still pictures) 109
 Video mode 67, 112
 Vivid color 89
 Voice memo 50
 Volume 50, 61, 65

W

WAV 116
 Welcome screen 102
 White balance 84

Z

Zoom 23
 Zoom button 5, 23, 61, 65

Nikon

No reproduction in any form of this manual, in whole or in part (except for brief quotation in critical articles or reviews), may be made without written authorization from NIKON CORPORATION.



NIKON CORPORATION

Fuji Bldg., 2-3 Marunouchi 3-chome,
Chiyoda-ku, Tokyo 100-8331, Japan

Printed in Japan
YP7H03800101(11)
6MA31311-01