

Nikon

DIGITAL CAMERA

COOLPIX S610/S610c

User's Manual

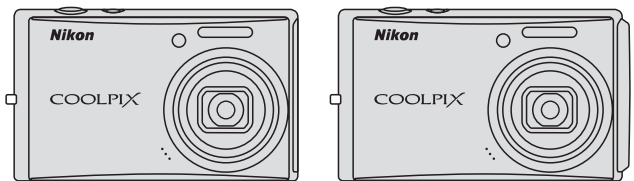

En

Trademark Information

- Microsoft and Windows Vista are either registered trademarks or trademarks of Microsoft Corporation in the United States and/or other countries.
- Macintosh, Mac OS, and QuickTime are trademarks of Apple Inc.
- Adobe and Acrobat are registered trademarks of Adobe Systems Inc.
- The SD logo is a trademark of the SD Card Association.
- PictBridge is a trademark.
- All other trade names mentioned in this manual or the other documentation provided with your Nikon product are trademarks or registered trademarks of their respective holders.

Introduction

First Steps



**Basic Photography and Playback:
Auto Mode**



Shooting Suited for the Scene



**Focusing on a Moving Subject in Active Child
Mode**



Automatic Shooting of a Smiling Face



More on Playback



Movies



Voice Recordings

Connecting to Televisions, Computers, and Printers

Shooting, Playback, and Setup Menus

Technical Notes

For Your Safety

To prevent damage to your Nikon product or injury to yourself or to others, read the following safety precautions in their entirety before using this equipment. Keep these safety instructions where all those who use the product will read them. The consequences that could result from failure to observe the precautions listed in this section are indicated by the following symbol:



This icon marks warnings, information that should be read before using this Nikon product to prevent possible injury.

WARNINGS

Turn off in the Event of Malfunction

Should you notice smoke or an unusual smell coming from the camera or AC adapter, unplug the AC adapter and remove the battery immediately, taking care to avoid burns. Continued operation could result in injury. After removing or disconnecting the power source, take the equipment to a Nikon-authorized service representative for inspection.

Do not Disassemble

Touching the internal parts of the camera or AC adapter could result in injury. Repairs should be performed only by qualified technicians. Should the camera or AC adapter break open as the result of a fall or other accident, take the product to a Nikon-authorized service representative for inspection, after unplugging the product and/or removing the battery.

Do not use the Camera or AC Adapter in the Presence of Flammable Gas

Do not use electronic equipment in the presence of flammable gas, as this could result in explosion or fire.

Handle the Camera Strap with Care

Never place the strap around the neck of an infant or child.

Keep out of Reach of Children

Particular care should be taken to prevent infants from putting the battery or other small parts into their mouths.

⚠ Observe the following precautions when handling the battery

The battery may leak or explode if improperly handled. Observe the following precautions when handling the battery for use in this product:

- Before replacing the battery, turn the product off. If you are using the AC adapter, be sure it is unplugged.
- Use only a Rechargeable Li-ion Battery EN-EL12 (supplied). Charge the battery by inserting it into a Battery Charger MH-65 (supplied only with the COOLPIX S610), or by inserting it into the camera and connecting the AC Adapter EH-63 (supplied only with the COOLPIX S610c).
- When inserting the battery, do not attempt to insert it upside down or backwards.
- Do not short or disassemble the battery or attempt to remove or break the battery insulation or casing.
- Do not expose the battery to flame or to excessive heat.
- Do not immerse in or expose to water.
- Replace the terminal cover when transporting the battery. Do not transport or store with metal objects such as necklaces or hairpins.
- The battery is prone to leakage when fully discharged. To avoid damage to the product, be sure to remove the battery when no charge remains.

- Discontinue use immediately should you notice any change in the battery, such as discoloration or deformation.
- If liquid from the damaged battery comes in contact with clothing or skin, rinse immediately with plenty of water.

⚠ Observe the following precautions when handling the battery charger/AC adapter

- Do not use with travel converters or adapters designed to convert from one voltage to another or with DC-to-AC inverters. Failure to observe this precaution could damage the product or cause overheating or fire.
- Keep dry. Failure to observe this precaution could result in fire or electric shock.
- Dust on or near the metal parts of the plug should be removed with a dry cloth. Continued use could result in fire.
- Do not handle the power cable or go near the battery charger/AC adapter during lightning storms. Failure to observe this precaution could result in electric shock.
- Do not damage, modify, forcibly tug or bend the power cable, place it under heavy objects, or expose it to heat or flame. Should the insulation be damaged and the wires become exposed, take it to a Nikon-authorized service representative for inspection. Failure to observe these precautions could result in fire or electric shock.

For Your Safety

- Do not handle the plug or battery charger/AC adapter with wet hands. Failure to observe this precaution could result in electric shock.

Use appropriate cables

When connecting cables to the input and output jacks, use only the cables provided or sold by Nikon for the purpose, to maintain compliance with product regulations.

Handle moving parts with care

Be careful that your fingers or other objects are not pinched by the lens cover or other moving parts.

CD-ROMs

The CD-ROMs supplied with this device should not be played back on audio CD equipment. Playing CD-ROMs on an audio CD player could cause hearing loss or damage the equipment.

Observe caution when using the flash

Using the flash close to your subject's eyes could cause temporary visual impairment. Particular care should be observed if photographing infants, when the flash should be no less than one meter (39 in.) from the subject.

Do not operate the flash with the flash window touching a person or object

Failure to observe this precaution could result in burns or fire.

Avoid contact with liquid crystal

Should the monitor break, care should be taken to avoid injury caused by broken glass and to prevent liquid crystal from the monitor touching the skin or entering the eyes or mouth.

Notices

Notice for Customers in the U.S.A.

Federal Communications Commission (FCC) Radio Frequency Interference Statement

This equipment has been tested and found to comply with the limits for a Class B digital device, pursuant to Part 15 of the FCC rules. These limits are designed to provide reasonable protection against harmful interference in a residential installation. This equipment generates, uses, and can radiate radio frequency energy and, if not installed and used in accordance with the instructions, may cause harmful interference to radio communications. However, there is no guarantee that interference will not occur in a particular installation. If this equipment does cause harmful interference to radio or television reception, which can be determined by turning the equipment off and on, the user is encouraged to try to correct the interference by one or more of the following measures:

- Reorient or relocate the receiving antenna.
- Increase the separation between the equipment and receiver.
- Connect the equipment into an outlet on a circuit different from that to which the receiver is connected.

- Consult the dealer or an experienced radio/television technician for help.



CAUTIONS

Modifications

The FCC requires the user to be notified that any changes or modifications made to this device that are not expressly approved by Nikon Corporation may void the user's authority to operate the equipment.

Interface Cables

Use the interface cables sold or provided by Nikon for your equipment. Using other interface cables may exceed the limits of Class B Part 15 of the FCC rules.

Notice for customers in the State of California

WARNING: Handling the cord on this product will expose you to lead, a chemical known to the State of California to cause birth defects or other reproductive harm. ***Wash hands after handling.***

Nikon Inc.,
1300 Walt Whitman Road
Melville, New York 11747-3064
USA
Tel: 631-547-4200

Notice for customers in Canada

CAUTION

This Class B digital apparatus complies with Canadian ICES-003.

ATTENTION

Cet appareil numérique de la classe B est conforme à la norme NMB-003 du Canada.

Symbol for Separate Collection in European Countries

This symbol indicates that this product is to be collected separately.



The following apply only to users in European countries:

- This product is designated for separate collection at an appropriate collection point. Do not dispose of as household waste.
- For more information, contact the retailer or the local authorities in charge of waste management.

This symbol on the battery indicates that the battery is to be collected separately.



The following apply only to users in European countries:

- This battery is designated for separate collection at an appropriate collection point. Do not dispose of as household waste.
- For more information, contact the retailer or the local authorities in charge of waste management.

Table of Contents













For Your Safety	ii
WARNINGS	ii
Notices	v
<hr/>	
Introduction	1
About This Manual	1
Information and Precautions	2
Parts of the Camera	4
The Camera Body	4
Attaching the Camera Strap	4
The Monitor	6
Basic Operations	8
The  (shooting/playback) Button	8
The MODE (mode) Button	8
The Rotary Multi Selector	9
The MENU Button	11
Help Displays	11
<hr/>	
First Steps	12
Charging the Battery Using the Battery Charger (COOLPIX S610)	12
Inserting the Battery into the Camera	14
Removing the Battery	15
Turning On and Off the Camera	15
Charging the Battery Using the AC Adapter (COOLPIX S610c)	16
Setting Display Language, Date, and Time	18
Inserting Memory Cards	20
Removing Memory Cards	21
<hr/>	
 Basic Photography and Playback: Auto Mode	22
Step 1 Turn the Camera On and Select  (Auto) Mode	22
Step 2 Frame a Picture	24
Step 3 Focus and Shoot	26
Step 4 Viewing and Deleting Pictures	28
Using the Flash	30
Setting the Flash Mode	30
Taking Pictures with the Self-Timer	32
Macro Mode	33
Exposure Compensation	34

Table of Contents

Shooting Suited for the Scene.....	35
 Shooting in Scene Mode.....	35
Setting the Scene Mode.....	35
Features	36
Taking Pictures in Food Mode.....	41
Taking Pictures for a Panorama	43
 Shooting in the Scene Mode Selected by the Camera (Scene Auto Selector).....	45
Taking Pictures in Scene Auto Selector Mode.....	45
<hr/>	
 Focusing on a Moving Subject in Active Child Mode	47
Active Child Mode	47
<hr/>	
 Automatic Shooting of a Smiling Face	49
Shooting in Smile Mode.....	49
<hr/>	
 More on Playback.....	51
Viewing Multiple Pictures: Thumbnail Playback	51
Taking a Closer Look: Playback Zoom	52
Editing Pictures.....	53
Enhancing Brightness and Contrast: D-Lighting.....	54
Creating a Cropped Copy: Crop.....	55
Resizing Pictures: Small Picture.....	56
Voice Memos: Recording and Playback	57
Viewing Pictures by Date	58
<hr/>	
 Movies	61
Recording Movies	61
The Movie Menu.....	62
 Selecting Movie Options.....	62
 Autofocus Mode	62
Movie Playback.....	63
Deleting Movie Files.....	63
<hr/>	
 Voice Recordings.....	64
Making Voice Recordings.....	64
Playing Voice Recordings.....	66
Deleting Sound Files.....	67
Copying Voice Recordings.....	68

Connecting to Televisions, Computers, and Printers	69
Connecting to a TV	69
Connecting to a Computer	70
Before Connecting the Camera	70
Transferring Pictures from a Camera to a Computer	71
Connecting to a Printer	74
Connecting the Camera and Printer	75
Printing Pictures One at a Time	76
Printing Multiple Pictures	77
Creating a DPOF Print Order: Print Set	80































Shooting, Playback, and Setup Menus	82
Shooting Options: The Shooting Menu	82
Displaying the Shooting Menu	82
 Image Mode	83
 White Balance	85
 Metering	87
 Continuous	88
 ISO Sensitivity	89
 Color Options	89
 AF Area Mode	90
 Autofocus Mode	93
Functions that Cannot Be Applied Simultaneously	94
Playback Options: The Playback Menu	95
Displaying the Playback Menu	95
 Slide Show	97
 Delete	98
 Protect	98
 Rotate Image	99
 Copy	100

Table of Contents

Basic Camera Setup: The Setup Menu	101
Displaying the Setup Menu.....	102
 Menus.....	102
 Welcome Screen.....	103
 Date.....	104
 Monitor Settings.....	107
 Date Imprint.....	108
 Vibration Reduction.....	109
 Motion Detection.....	110
 AF Assist.....	110
 Digital Zoom.....	111
 Sound Settings.....	111
 Auto Off.....	112
 Format Memory/  Format Card.....	112
 Language.....	113
 Video Mode.....	113
 Reset All.....	113
 Firmware Version.....	115
<hr/>	
Technical Notes	116
Optional Accessories	116
Approved Memory Cards.....	116
Image/Sound File and Folder Names	117
Caring for the Camera	118
Cleaning.....	120
Storage.....	120
Error Messages	121
Troubleshooting	125
Specifications	130
Supported Standards.....	133
Index	134

About This Manual

Thank you for your purchase of a Nikon COOLPIX S610/S610c digital camera. This manual was written to help you enjoy taking pictures with your Nikon digital camera. Read this manual thoroughly before use, and keep it where all those who use the product will read it.

Symbols and Conventions

To make it easier to find the information you need, the following symbols and conventions are used:



This icon marks cautions, information that should be read before use to prevent damage to the camera.



This icon marks tips, additional information that may be helpful when using the camera.



This icon marks notes, information that should be read before using the camera.



This icon indicates that more information is available elsewhere in this manual or in the *Quick Start Guide*.

Notations

- A Secure Digital (SD) memory card is referred to as a “memory card.”
- The setting at the time of purchase is referred to as the “default setting.”
- The names of menu items displayed in the camera monitor, and the names of buttons or messages displayed in a computer monitor are indicated in bold text.

Screen Samples

In this manual, images are sometimes omitted from monitor display samples so that monitor indicators can be more clearly shown.

Illustrations and Screen Display

- In this manual, the COOLPIX S610 digital camera is used for illustrative purposes. Illustrations for both the COOLPIX S610 and the COOLPIX S610c are provided when necessary.
- Illustrations and text displays shown in this manual may differ from actual display.

Memory Cards

Pictures taken with this camera can be stored in the camera’s internal memory or on removable memory cards. If a memory card is inserted, all new pictures will be stored on the memory card and delete, playback, and format operations will apply only to the pictures on the memory card. The memory card must be removed before the internal memory can be formatted or used to store pictures to, or delete, or view pictures.

Information and Precautions

Life-Long Learning

As part of Nikon's "Life-Long Learning" commitment to ongoing product support and education, continually updated information is available online at the following sites:

- For users in the U.S.A.: <http://www.nikonusa.com/>
- For users in Europe and Africa: <http://www.europe-nikon.com/support/>
- For users in Asia, Oceania, and the Middle East: <http://www.nikon-asia.com/>

Visit these sites to keep up-to-date with the latest product information, tips, answers to frequently asked questions (FAQs), and general advice on digital imaging and photography. Additional information may be available from the Nikon representative in your area. See the URL below for contact information:

<http://imaging.nikon.com/>

Use Only Nikon Brand Electronic Accessories

Nikon COOLPIX cameras are designed to the highest standards and include complex electronic circuitry. Only Nikon brand electronic accessories (including battery chargers, batteries and AC adapters) certified by Nikon specifically for use with this Nikon digital camera are engineered and proven to operate within the operational and safety requirements of this electronic circuitry.

THE USE OF NON-NIKON ELECTRONIC ACCESSORIES COULD DAMAGE THE CAMERA AND MAY VOID YOUR NIKON WARRANTY.

The use of third-party rechargeable Li-ion batteries not bearing the Nikon holographic seal could interfere with normal operation of the camera or result in the batteries overheating, igniting, rupturing, or leaking.

For more information about Nikon brand accessories, contact a local authorized Nikon dealer.

Holographic seal:

Identifies this device as an authentic Nikon product.



Rechargeable Li-ion
Battery EN-EL12

Before Taking Important Pictures

Before taking pictures on important occasions (such as at weddings or before taking the camera on a trip), take a test shot to ensure that the camera is functioning normally. Nikon will not be held liable for damages or lost profits that may result from product malfunction.

About the Manuals

- No part of the manuals included with this product may be reproduced, transmitted, transcribed, stored in a retrieval system, or translated into any language in any form, by any means, without Nikon's prior written permission.
- Nikon reserves the right to change the specifications of the hardware and software described in these manuals at any time and without prior notice.
- Nikon will not be held liable for any damages resulting from the use of this product.
- While every effort was made to ensure that the information in these manuals is accurate and complete, we would appreciate it were you to bring any errors or omissions to the attention of the Nikon representative in your area (address provided separately).

Notice Concerning Prohibition of Copying or Reproduction

Note that simply being in possession of material that was digitally copied or reproduced by means of a scanner, digital camera or other device may be punishable by law.

• Items prohibited by law from being copied or reproduced

Do not copy or reproduce paper money, coins, securities, government bonds or local government bonds, even if such copies or reproductions are stamped "Sample".

The copying or reproduction of paper money, coins, or securities which are circulated in a foreign country is prohibited.

Unless the prior permission of the government was obtained, the copying or reproduction of unused postage stamps or post cards issued by the government is prohibited.

The copying or reproduction of stamps issued by the government and of certified documents stipulated by law is prohibited.

• Cautions on certain copies and reproductions

The government has issued cautions on copies or reproductions of securities issued by private companies (shares, bills, checks, gift certificates, etc.), commuter passes or coupon tickets, except when a minimum of necessary copies are to be provided for business use by a company. Also, do not copy or reproduce passports issued by the government, licenses issued by public agencies and private groups, ID cards and tickets, such as passes and meal coupons.

• Comply with copyright notices

The copying or reproduction of copyrighted creative works such as books, music, paintings, woodcut prints, maps, drawings, movies and photographs is governed by national and international copyright laws. Do not use this product for the purpose of making illegal copies or to infringe copyright laws.

Disposing of Data Storage Devices

Please note that deleting images or formatting data storage devices such as memory cards or built-in camera memory does not completely erase the original image data. Deleted files can sometimes be recovered from discarded storage devices using commercially available software, potentially resulting in the malicious use of personal image data. Ensuring the privacy of such data is the user's responsibility.

Before discarding a data storage device or transferring ownership to another person, erase all data using commercial deletion software, or format the device and then completely refill it with images containing no private information (for example, pictures of empty sky). Be sure to also replace any pictures selected for the welcome screen (📷 103). Care should be taken to avoid injury or damage to property when physically destroying data storage devices.

If you are using the COOLPIX S610c, reset the wireless LAN settings stored in the camera. For more information, see page 23 and 37 of the *Wireless LAN Connection Guide*.

Parts of the Camera

The Camera Body

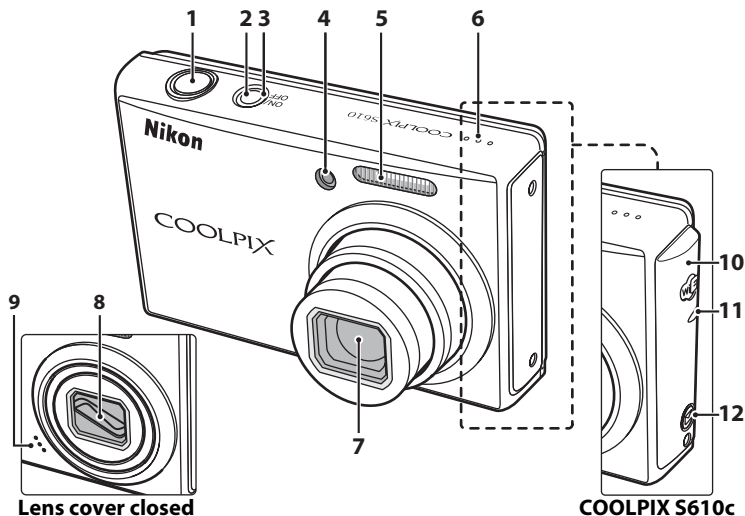

Lens cover closed

COOLPIX S610c

- 1** Shutter-release button.....26
- 2** Power switch.....15
- 3** Power-on lamp.....22, 112
- 4** Self-timer lamp32
- 4** AF-assist illuminator.....27, 110
- 5** Built-in flash30
- 6** Speaker57, 63, 66
- 7** Lens.....118, 130
- 8** Lens cover

- 9** Built-in microphone.....57, 61, 64

COOLPIX S610c only

- 10** Antenna
... 50 of the *Wireless LAN Connection Guide*
- 11** Wireless LAN LED
... 50 of the *Wireless LAN Connection Guide*
- 12**  (Picture Mail) button
... 44 of the *Wireless LAN Connection Guide*

Attaching the Camera Strap

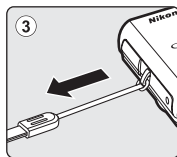
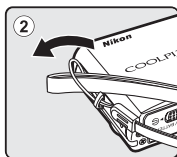
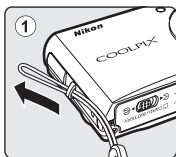

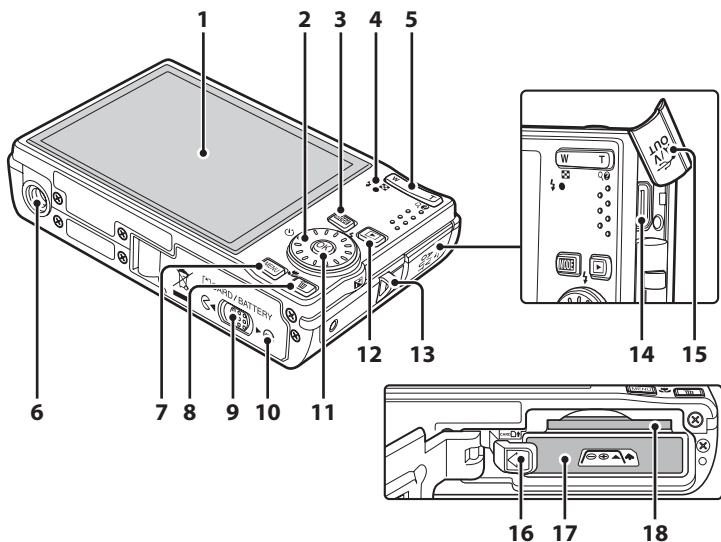

1	Monitor	6	9	Cover latch	14, 20
2	Rotary multi selector	9	10	Battery-chamber/ memory card slot cover	14, 20
3	MODE (mode) button	8	11	OK (apply selection) button	9
4	Indicator lamp	64	12	▶ (shooting/playback) button	8, 28
	Flash lamp	31	13	Eyelet for camera strap	4
5	Zoom buttons	24	14	Multi connector	69, 71, 75
	W (wide)	24	15	Connector cover	
	T (tele)	24	16	Battery latch	14, 15
	ⓧ (thumbnail playback)	51	17	Battery chamber	14
	Q (playback zoom)	52	18	Memory card slot	20
	? (help)	11			
6	Tripod socket				
7	MENU button	11, 82, 95			
8	ⓧ (delete) button	28, 29, 57, 63			

The Monitor

The following indicators may appear in the monitor during shooting and playback (actual display varies with current camera settings).

The indicators and photo info displayed during shooting and playback will turn off after a few seconds (☒ 107).

Shooting

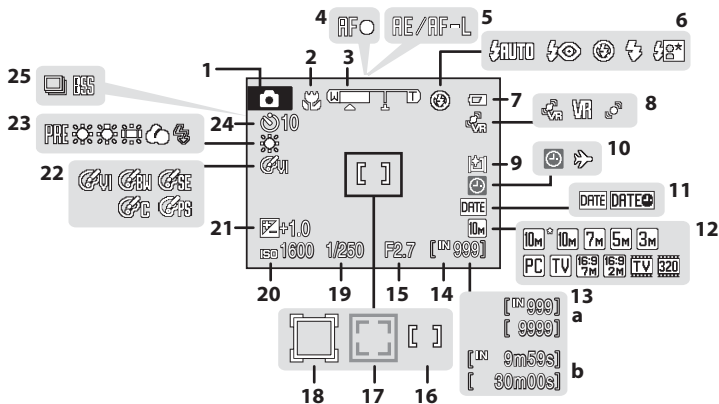

1	Shooting mode*22, 35, 45, 47, 49, 61	13	(a) Number of exposures remaining (still pictures)..... 22
2	Macro mode..... 33		(b) Movie length..... 61
3	Zoom indicator..... 24, 33	14	Internal memory indicator..... 23
4	Focus indicator..... 26	15	Aperture..... 26
5	AE/AF-L indicator..... 44	16	Focus area..... 26, 90
6	Flash mode..... 30	17	Focus area (Face Priority)..... 49, 90
7	Battery level indicator..... 22	18	Focus area (Active child)..... 47
8	Vibration reduction/ Motion detection icon..... 23, 109, 110	19	Shutter speed..... 26
9	Monitor brightness boost indicator..... 23	20	ISO sensitivity..... 31, 89
10	"Date not set" indicator..... 121	21	Exposure compensation value..... 34
	Time zone indicator..... 104	22	Color options..... 89
11	Date imprint..... 108	23	White balance mode..... 85
12	Image mode..... 83	24	Self-timer indicator..... 32
	Movie option..... 62	25	Continuous shooting mode..... 88

* Differs according to the current shooting mode. Refer to the sections on each mode for details.

Playback

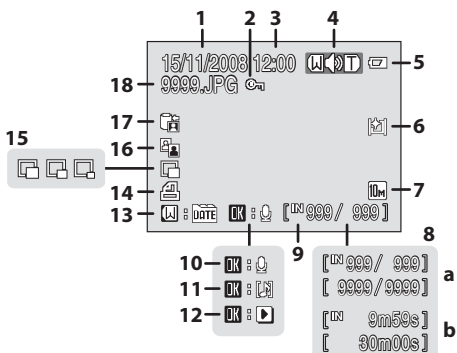



1	Date of recording.....	18	10	Voice memo recording guide	57
2	Protect icon.....	98	11	Voice memo playback guide	57
3	Time of recording.....	18	12	Movie playback indicator	63
4	Volume indicator	57, 63, 66	13	List by date guide.....	58
5	Battery level indicator	22	14	Print-order icon.....	80
6	Monitor brightness boost indicator ...	23	15	Small picture.....	55, 56
7	Image mode*	83	16	D-Lighting icon.....	54
	Movie option*	63		Picture Bank pictures icon (COOLPIX S610c only) ... 48 of the <i>Wireless LAN Connection Guide</i>	
8	(a) Current frame number/ total number of frames.....	28	17		
	(b) Movie length	63	18	File number and type	117
9	Internal memory indicator.....	28			



* Differs according to the selected option.

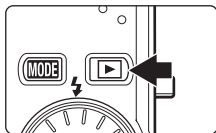

Basic Operations

The (shooting/playback) Button



Press the  button once in shooting mode to enter playback mode; press again to switch back to shooting mode.



If the camera is turned off, hold down the  button to turn the camera on in playback mode ( 28).

Holding down the  button when the camera is on sets monitor brightness to the maximum level. Hold down the  button again to change back to the original brightness. The  icon will be displayed in the monitor when monitor brightness is set to the maximum level.

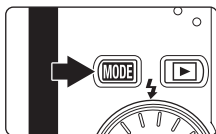
The **MODE** (mode) Button



Use the **MODE** button to choose the shooting, playback, or setup mode.

- Press the **MODE** button during shooting to display the shooting-mode selection menu, or during playback to display the playback-mode selection menu.
- Press the  button to switch between the mode selection menu for shooting mode and playback mode.
- Use the rotary multi selector to choose the desired mode from the shooting-mode or playback-mode selection menu ( 9).

Shooting-mode Selection Menu



1	Auto mode	22	5	Scene auto selector	45
2	Smile mode	49	6	Voice recording mode	64
3	Active child mode	47	7	Movie mode	61
4	Scene mode	35	8	Setup mode	101

Playback-mode Selection Menu

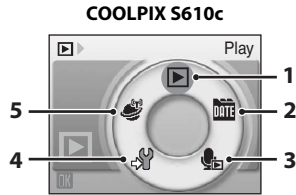
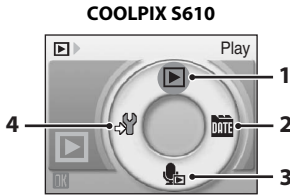

- | | | |
|----------|--------------------------------|----|
| 1 | Playback mode | 28 |
| 2 | List by date mode | 58 |
| 3 | Sound file playback mode | 66 |

- | | | |
|----------|--|-----|
| 4 | Setup mode | 101 |
| 5 | Picture Bank mode
(COOLPIX S610c only)
...47 of the <i>Wireless LAN Connection Guide</i> | |

The Rotary Multi Selector

This section describes standard uses of the rotary multi selector to select modes, select menu options, and to apply selection.

For Shooting

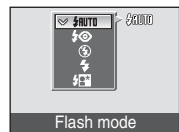
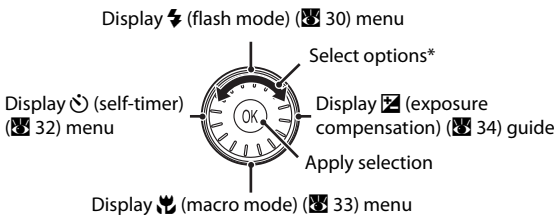

* Items can also be selected by pressing the rotary multi selector up or down.

For Playback

Select previous picture*

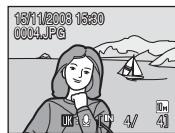
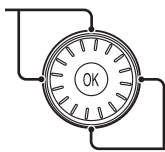

Select next picture*

* Subsequent or previous pictures can also be selected by rotating the rotary multi selector.

For the Menu Screen

Return display to the previous screen

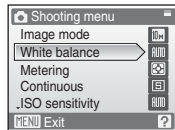
Select options¹Apply selection (advance display to the next screen)²

- ¹ Items can also be selected by pressing the rotary multi selector up or down. Pressing right or left in shooting/playback-mode selection menu (8) or icons menu (102) will choose the items.
- ² Pressing right in text menus (102) advances display to the next screen.

Note on the Rotary Multi Selector

In this manual, up, down, left, and right presses of the rotary multi selector may be indicated with ▲, ▼, ◀, and ▶.

The MENU Button

Press the **MENU** button to display the menu for the selected mode. Use the rotary multi selector to navigate the menus (10). Press the **MENU** button again to exit the menu.

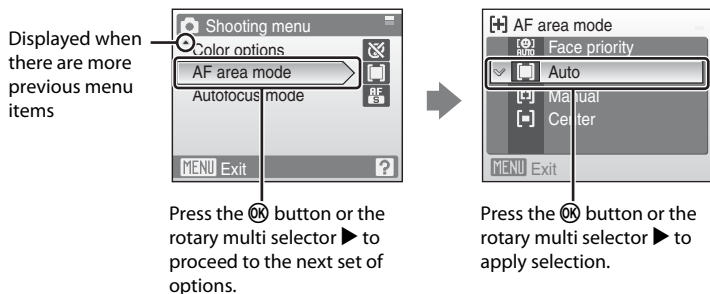
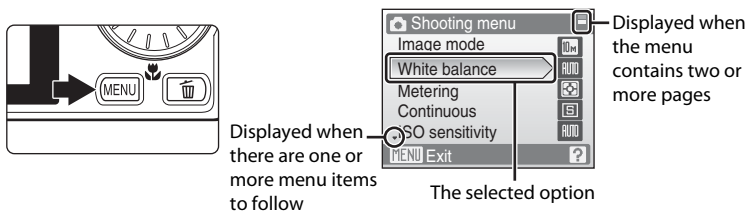

Help Displays

Press the **T** (?) button when ? is displayed at the lower right of the menu screen to view a description of the currently selected menu option.

To return to the original menu, press the **T** (?) button again.

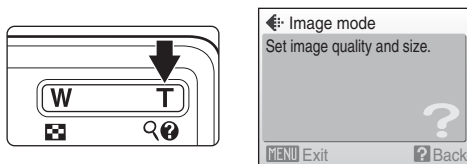

Charging the Battery Using the Battery Charger (COOLPIX S610)

If you are using the COOLPIX S610, charge the Rechargeable Li-ion Battery EN-EL12 (supplied) using the Battery Charger MH-65 (supplied).

- If you are using the COOLPIX S610c, the Battery Charger MH-65 is not supplied with the camera. Insert the battery into the camera and charge it by connecting the AC adapter. Proceed to "Inserting the Battery into the Camera" (📖 14) and "Charging the Battery Using the AC Adapter (COOLPIX S610c)" (📖 16).

1 Connect the power cable.

Connect the power cable to the battery charger ① and insert the wall plug into a power outlet ②. The CHARGE lamp will light to show that the charger is on ③.

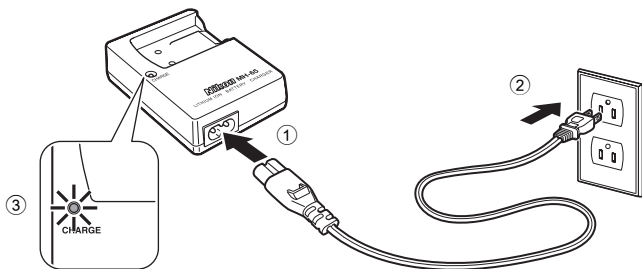

2 Charge the battery.

Insert the battery into the battery charger. Slide the battery forward ① and then press down until it locks into place ②.

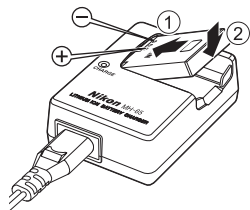

CHARGE lamp starts blinking ③ when battery is inserted. Charging is complete when lamp stops blinking ④.

About 150 minutes are required to charge a fully exhausted battery.

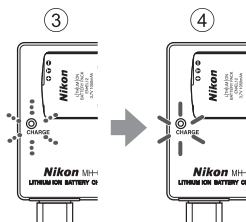

The following chart explains CHARGE lamp status.

CHARGE lamp	Description
Blinks	Battery charging.
On	Battery fully charged.
Flickers	<p>The battery is not inserted correctly. Remove the battery and reinsert it into the battery charger so that the battery is lying flat.</p> <ul style="list-style-type: none"> Charge the battery indoors with an ambient temperature of 5 °C to 35 °C (41 °F to 95 °F) before use. The battery is faulty. Unplug the charger immediately and stop charging the battery. Bring the battery and charger to a Nikon-authorized service representative for inspection.

3 Unplug the charger.

Remove the battery and unplug the charger.

Notes on the Battery Charger

- The supplied battery charger is for use only with a Rechargeable Li-ion Battery EN-EL12. Do not use with incompatible batteries.
- Be sure to read and follow the warnings for the battery charger on page iii before using the battery charger.
- Be sure to read the section, “The Battery” (📖 119), thoroughly before use.

Notes on AC Power Supply

- To power the camera continuously for extended periods, use the AC Adapter EH-63 (available separately from Nikon) (📖 116). Do not, under any circumstances, use another make or model of AC adapter. Failure to observe this precaution could result in overheating or in damage to the camera.
- If you are using the COOLPIX S610, the battery cannot be charged by inserting it into the camera and connecting the AC adapter. The AC adapter and the supplied audio/video cable or USB cable cannot be used at the same time.

Inserting the Battery into the Camera

Insert a Rechargeable Li-ion Battery EN-EL12 (supplied) into the camera.

- Charge the battery before the first use or when the battery is running low. For more information about charging the battery, see “Charging the Battery Using the Battery Charger (COOLPIX S610)” (📖 12) if you are using the COOLPIX S610, or “Charging the Battery Using the AC Adapter (COOLPIX S610c)” (📖 16) if you are using the COOLPIX S610c.

1 Open the battery-chamber/memory card slot cover.

Slide the cover latch to the ☞ position ①.

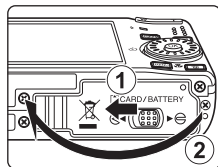

2 Insert the battery.

Confirm that the positive (+) and negative (-) terminals are oriented correctly as described on the label at the entrance of the battery chamber, and insert the battery.

Use the battery to push the orange battery latch in the direction indicated by the arrow ① and fully insert the battery ②. When the battery is fully inserted, the battery latch will lock it in place.

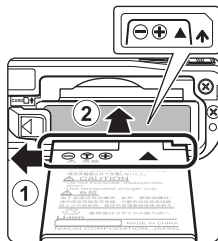

✔ Inserting the Battery

Inserting the battery upside down or backwards could damage the camera. Be sure to check the battery is in the correct orientation.



3 Close the battery-chamber/memory card slot cover.

Slide the cover latch to the ☜ position ②.

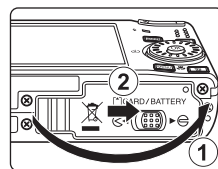

Removing the Battery

Turn the camera off and confirm that the power-on lamp and the monitor are off before opening the battery-chamber/memory card slot cover. To eject the battery, open the battery-chamber/memory card slot cover and slide the battery latch in the direction shown ①. The battery can then be removed by hand ②.

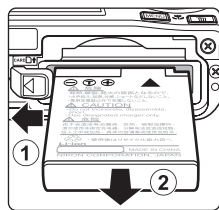

- Note that the battery may become hot during use; observe due caution when removing the battery.



Turning On and Off the Camera

To turn on the camera, press the power switch. The power-on lamp (green) will light for a moment and the monitor will turn on. To turn off the camera, press the power switch again.

When the camera turns off, both the power-on lamp and monitor will turn off.

- If the camera is turned off, hold down the  button to turn the camera on in playback mode ( 28).

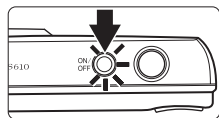





Note on the Battery

- Be sure to read and follow the warnings for the battery on page iii and the section, "The Battery" ( 119), before using the battery.
- If the battery will not be used for an extended period, recharge it at least once every six months and run it flat before returning it to storage.

Auto Power Off in Shooting Mode (Standby Mode)

If no operations are performed for about five seconds in shooting mode, the monitor will dim to save power. Using any of the camera controls will reactivate the display. If no operations are performed for about a minute (default setting), the monitor will turn off automatically and the camera will enter standby mode. If no operations are performed for another three minutes, the camera will turn off automatically (the auto off function).

If the monitor is off in standby mode, press the power switch or the shutter-release button to reactivate it.

- The time allowed to elapse before the camera enters standby mode can be changed from the **Auto off** option ( 112) in the setup menu ( 112).
- When monitor brightness is set to the maximum level by pressing the  button ( 23), the monitor will not dim, even if no operations are performed.

Charging the Battery Using the AC Adapter (COOLPIX S610c)

If you are using the COOLPIX S610c, insert a Rechargeable Li-ion Battery EN-EL12 (supplied) into the camera and charge the battery by connecting the AC Adapter EH-63 (supplied).

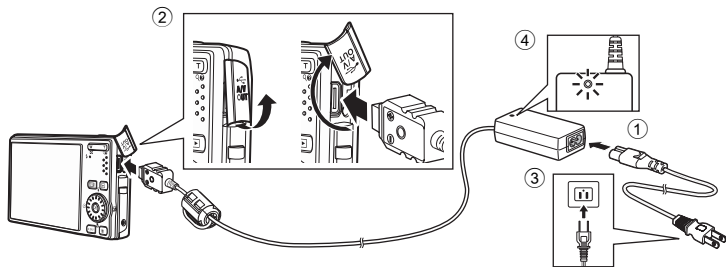

1 Connect the power cable and AC adapter ①.

2 Confirm that the power-on lamp and the monitor are off.

Do not turn the camera on. The battery cannot be charged when the camera is on.

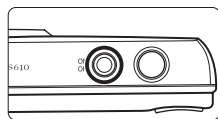

3 Connect the AC adapter to the camera's multi connector ②.

The multi connector should be fully inserted.

4 Plug the power cable into an outlet ③.

The AC adapter power-on lamp will light ④.

Charging the Battery After Setting the Camera's Clock

When the camera's built-in clock has not been set, the battery begins charging when the AC adapter is connected. Once the clock is set and the AC adapter is connected, the Picture Bank start-up screen will be displayed and the camera will attempt to upload pictures to the my Picturetown server. Press the  button to cancel picture upload and charge the battery. Picture Bank can be set so that it does not start automatically when the AC adapter is connected. See the *Wireless LAN Connection Guide* for more information about Picture Bank.

5 The battery begins charging.

The power-on lamp (orange) will blink, and the battery will start charging.

The power-on lamp (orange) stops blinking when charging is complete.

A fully exhausted battery will recharge in about 150 minutes.

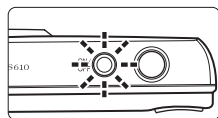

Charging the Battery Using the AC Adapter (COOLPIX S610c)

The following chart explains power-on lamp status of the COOLPIX S610c while the AC adapter is connected.

Power-on lamp	Description
Blinks (orange)	Battery charging.
On (orange)	Battery fully charged.
Off/Blinks (green)/ On (green)	The camera is on. Turn the camera off when charging.
Flickers (orange)	<ul style="list-style-type: none">• Charge the battery indoors with an ambient temperature of 5 °C to 35 °C (41 °F to 95 °F) before use.• If the lamp flickers rapidly, the AC adapter is not correctly connected or there is a problem with the battery. Reconnect the AC adapter or replace the battery.

6 Disconnect the camera and AC adapter when charging is complete.

Turn the camera off.

Disconnect the AC adapter from the camera's multi connector and unplug the power cable from the power outlet.

Note on the AC Adapter

- Be sure to read and follow the warning for the AC adapter on page ii.
- Be sure to read the section, "The Battery" (📖 119), thoroughly before use.
- Do not, under any circumstances, use another make or model of AC adapter. Failure to observe this precaution could result in overheating or in damage to the camera.
- Do not connect the power cable supplied with the AC Adapter EH-63 to any other device.

The AC Adapter EH-63

The AC Adapter EH-63 (supplied) can:

- When the camera is turned on, power the camera from a power outlet.
- If you are using the COOLPIX S610c, the battery inserted into the camera is charged when the camera is turned off with the AC adapter connected.
- If you are using the COOLPIX S610, the AC Adapter EH-63 is not supplied with the camera. Furthermore, the battery cannot be charged while it is inserted into the camera.
- The AC adapter and the supplied audio/video cable or USB cable cannot be used at the same time.

The Battery Charger MH-65

If you are using the COOLPIX S610c, the Battery Charger MH-65 (📖 116), for charging a Rechargeable Li-ion Battery EN-EL12, is available separately.

Setting Display Language, Date, and Time

A language-selection dialog is displayed the first time the camera is turned on.

1 Press the power switch to turn on the camera.

The power-on lamp (green) will light for a moment and the monitor will turn on.

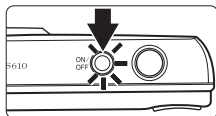

2 Use the rotary multi selector to choose the desired language and press the **OK** button.

For information about using the rotary multi selector, see "The Rotary Multi Selector" (📖 9).



3 Choose **Yes** and press the **OK** button.

If **No** is selected, the date and time will not be set.

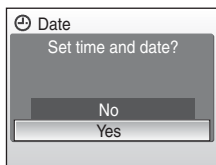

4 Press the rotary multi selector **◀** or **▶** to select your home time zone (📖 106) and press the **OK** button.

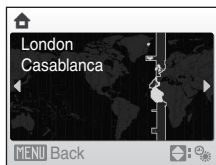

Daylight Saving Time

If daylight saving time is in effect, press the rotary multi selector ▲ in the time zone selection screen displayed in step 4 to turn on the daylight saving time option.

When the daylight saving time option is enabled,  is displayed at the top of the monitor. To turn off the daylight saving time option, press ▼.



5 Edit the date.

Rotate the rotary multi selector, or press ▲ or ▼, to edit the highlighted item.

Press ► to move the highlight in the following order.

D (day) → **M** (month) → **Y** (year) → hour → minute → **DMY** (the order in which the day, month, and year are displayed)

Press ◀ to return to the previous item.

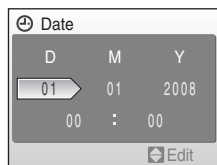

6 Choose the order in which the day, month, and year are displayed and press the **OK** button or the rotary multi selector ►.

The settings are applied and monitor display exits to shooting mode.

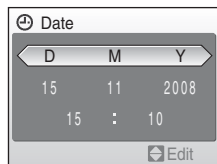

Changing the Date and Time

- Select **Date** from the **Date** item (🔍 104) in the setup menu (🔍 101) to change the current date and time and follow the procedure described in step 5 above.
- Select **Time zone** from the **Date** item in the setup menu to change the time zone and daylight saving time settings (🔍 104).

Inserting Memory Cards

Image, sound, and movie files are stored in the camera's internal memory (approx. 45 MB) or on removable memory cards (available separately) (▶ 116).

If a memory card is inserted in the camera, data are automatically stored on the memory card and data recorded to the memory card can be played back, deleted, or transferred. Remove the memory card to store data in the internal memory, or play back, delete, or transfer data from the internal memory.

- 1 Confirm the power-on lamp and the monitor are off and open the battery-chamber/memory card slot cover.

Be sure to turn off the camera before opening the battery-chamber/memory card slot cover.

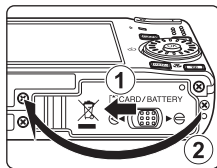

- 2 Insert the memory card.

Slide the memory card in correctly until it clicks into place.

Close the battery-chamber/memory card slot cover.

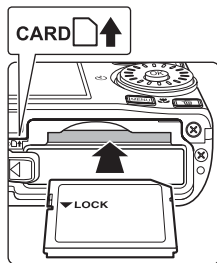

✔ Inserting Memory Cards

Inserting the memory card upside down or backwards could damage the camera or the memory card. Make sure that the memory card is correctly oriented.

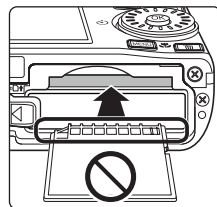

Removing Memory Cards

Before removing memory cards, **turn the camera off** and confirm that the power-on lamp and the monitor are off. Open the battery-chamber/memory card slot cover and press the card in ① to partially eject the card ②. The card can then be removed by hand.

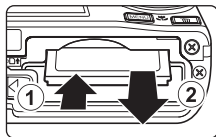

Formatting Memory Cards

If the message at right is displayed, the memory card must be formatted before use (☒ 112). Note that **formatting permanently deletes all pictures and other data on the memory card**. Be sure to make copies of any pictures you wish to keep before formatting the memory card.

Use the rotary multi selector to choose **Yes** and press the **OK** button. A confirmation dialog will be displayed. To start formatting, choose **Format** and press the **OK** button.

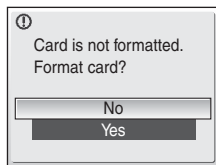

- **Do not turn the camera off or open the battery-chamber/memory card slot cover until formatting is complete.**

- The first time you insert the memory cards used in other devices into this camera, be sure to format them with this camera (☒ 112).

The Write Protect Switch

Memory cards are equipped with a write protect switch. When this switch is in the "lock" position, data cannot be written to, or deleted from, the memory card. If the switch is in the "lock" position, unlock it by sliding the switch to the "write" position to record or delete pictures, or to format the memory card.

- Be sure that the memory card's write protect switch is in the "write" position when transmitting pictures from the memory card to the my Picturetown server using the wireless LAN function built into the COOLPIX S610c.

Write protect switch

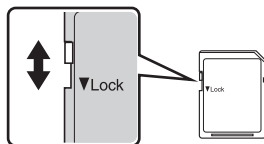

Memory Cards

- Use only Secure Digital memory cards.
- Do not perform the following during formatting, while data are being written to or deleted from the memory card, or during data transfer to a computer. Failure to observe this precaution could result in the loss of data or in damage to the camera or memory card:
 - Eject the memory card
 - Remove the battery
 - Turn off the camera
 - Disconnect the AC adapter
- Do not use a computer to format the memory card.
- Do not disassemble or modify.
- Do not drop, bend, or expose to water or strong physical shocks.
- Do not touch the metal terminals with your fingers or metal objects.
- Do not affix labels or stickers to the memory card.
- Do not leave in direct sunlight, closed vehicles, or areas exposed to high temperatures.
- Do not expose to humidity, dust, or to corrosive gases.

Step 1 Turn the Camera On and Select (Auto) Mode

This section describes how to take pictures in  (auto) mode, an automatic, “point-and-shoot” mode recommended for first-time users of digital cameras.

1 Press the power switch to turn on the camera.

The power-on lamp (green) will light for a moment and the monitor will turn on. The lens will also extend.

Proceed to step 4 when  is displayed.

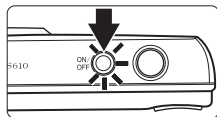

2 Press the **MODE** button.

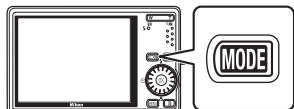

3 Use the rotary multi selector to choose and press the **OK** button.

The camera enters  (auto) mode.



4 Check the battery level and number of exposures remaining in the monitor.

Battery level

Monitor	Description
NO INDICATOR	Battery fully charged.
	Battery low; prepare to charge or replace the battery.
i Battery exhausted.	Cannot shoot. Recharge or replace with a fully charged battery.

Battery level indicator

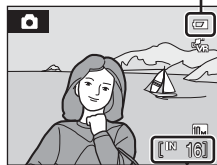



Number of exposures remaining

Number of Exposures Remaining



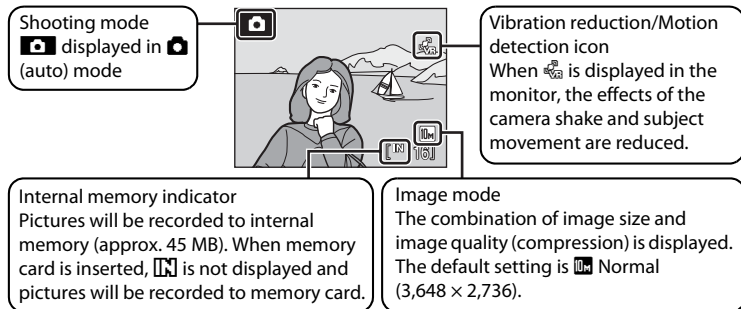

The number of pictures that can be stored depends on the capacity of the internal memory or memory card and image mode setting ( 84).

Indicators Displayed in (Auto) Mode









The indicators and photo info displayed during shooting and playback will turn off after a few seconds ( 107). When the monitor has turned off in standby mode to save power, press the power switch or the shutter-release button to reactivate it ( 112).

Monitor Brightness Boost

If it is difficult to see the monitor display when shooting outdoors, holding down the  button while the power is on to switch monitor brightness to the maximum setting. Hold down the  button again to change back to the original brightness. The  icon will be displayed in the monitor when the brightness setting is set to the maximum by pressing the  button.

Functions Available in (Auto) Mode







In  (auto) mode, macro mode ( 33) and exposure compensation ( 34) can be applied and pictures can be taken using the flash mode ( 30) and self-timer ( 32). Pressing the **MENU** button in  (auto) mode allows you to specify settings for all shooting menu items ( 82).

Vibration Reduction and Motion Detection Icons

The **Vibration reduction** option effectively reduces blur, caused by slight hand movement known as camera shake, that commonly occurs when shooting with zoom applied or at slow shutter speeds.

The **Motion detection** option detects camera shake and subject movement with shooting, and increases the shutter speed to reduce their effects. Motion detection does not function when recording movies.

The Vibration reduction/Motion detection icons indicate the following:

- : The setup menu's ( 101) **Vibration reduction** option ( 109) is set to **On**, and the **Motion detection** option ( 110) is set to **Auto** (default settings).
- : The **Vibration reduction** option is set to **On**, and the **Motion detection** option is set to **Off**.
- : The **Motion detection** option is set to **Auto**, and the **Vibration reduction** option is set to **Off**.
- **Off**: Both the **Vibration reduction** and **Motion detection** options are set to **Off**.
- Set **Vibration reduction** to **Off** when using a tripod to stabilize the camera during shooting.

Step 2 Frame a Picture

1 Ready the camera.

Hold the camera steadily in both hands, keeping your fingers and other objects away from the lens, flash, AF-assist illuminator, microphone, and speaker.

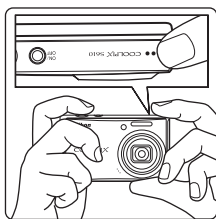

2 Frame the picture.

Position the main subject near the center of the monitor.



Using the Zoom

Use the zoom buttons to activate optical zoom. Press the **T** button to zoom in so that the subject fills a larger area of the frame, or the **W** button to zoom out, increasing the area visible in the frame.

A zoom indicator is displayed at the top of the monitor when the zoom button is pressed.

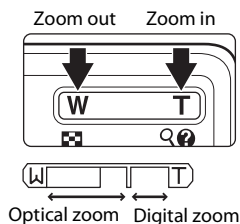

Digital Zoom

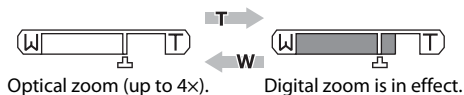

When the camera is zoomed in to the maximum optical zoom position, holding down the **T** button triggers digital zoom. The subject is magnified up to 4× the maximum optical zoom ratio.

When digital zoom is in effect, the focus area will not be displayed and the camera will focus on the subject in the center focus area.



Digital Zoom and Interpolation

Unlike optical zoom, digital zoom uses a digital imaging process known as interpolation to magnify images, resulting in slight deterioration of picture quality.

Interpolation is applied at zoom positions beyond . When zoom is increased beyond the  position, interpolation is initiated and the zoom indicator turns yellow to indicate that interpolation is being applied. The position of  moves to the right as image size decreases, allowing for confirmation of the zoom positions at which shooting without interpolation is possible at the current image mode setting.



Digital zoom can be disabled from the **Digital zoom** option ( 111) in the setup menu ( 101).

Step 3 Focus and Shoot

1 Press the shutter-release button halfway.

Camera automatically selects the focus area (one of nine) containing the subject closest to the camera. When the subject is in focus, the active focus area glows green.

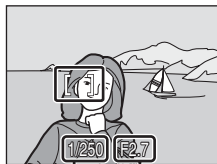
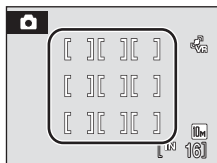
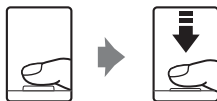

Shutter Speed Aperture

When digital zoom is in effect, the focus area is not displayed. When the camera focuses on the subject in the center of the monitor, the focus indicator (AF 6) will glow green.

Press the shutter-release button halfway to display the shutter speed and aperture.

Focus and exposure remain locked while the shutter-release button is pressed halfway.

When the camera is unable to focus, while the shutter-release button is pressed halfway, the focus area or focus indicator blinks red. Change the composition and try again.

2 Press the shutter-release button the rest of the way down.

The shutter will be released, and the picture will be recorded to the memory card or internal memory.



✓ During Recording

While pictures are being recorded, the number of exposures remaining display will blink. **Do not open the battery-chamber/memory card slot cover** while pictures are being recorded. Cutting power or removing the memory card in these circumstances could result in loss of data or in damage to the camera or card.

🔗 Autofocus

Autofocus may not perform as expected in the following situations. In some rare cases, the subject may not be in focus despite the fact that the active focus area, or focus indicator, glows green:

- Subject is very dark
- Objects of sharply differing brightness are included in the scene (e.g., the sun is behind the subject and is in deep shadow)
- No contrast between the subject and surroundings (e.g., when the subject is standing in front of a white wall, wearing a white shirt)
- Several objects are at different distances from the camera (e.g., the subject is inside a cage)
- Subject is moving rapidly

In the situations noted above, try pressing the shutter-release button halfway to refocus several times, or focus on another subject and use focus lock (🔒 91). When using focus lock, be sure that the distance between the camera and the subject with which focus was locked is the same as that for the actual subject.

🔍 Shutter-Release Button

The camera features a two-stage shutter-release button. To set focus and exposure, press the shutter-release button halfway, stopping when you feel resistance. Focus and exposure lock while the shutter-release button is held in this position. To release the shutter and take a picture, press the shutter-release button the rest of the way down.

Do not use force when pressing the shutter-release button, as this may result in camera shake and blurred pictures.

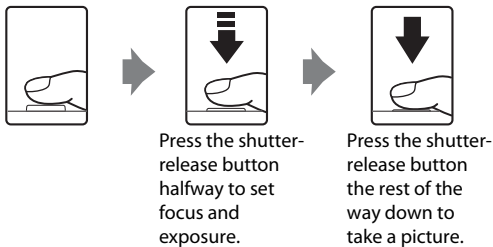

🔍 AF-assist Illuminator and Flash





If the subject is poorly lit, the AF-assist illuminator (🔦 110) may light by pressing the shutter-release button halfway, or the flash (🔦 30) may fire by pressing the shutter-release button all the way down.

Step 4 Viewing and Deleting Pictures

Viewing Pictures (Playback Mode)



Press the  button.

The last picture taken will be displayed in full-frame playback mode.

Rotate the rotary multi selector, or press , , , or , to view additional pictures ( 9).

Pictures may be displayed briefly at low resolution while being read from the memory card or internal memory.

Press the  button to switch to shooting mode.

When  is displayed, pictures stored in the internal memory will be displayed. When memory card is inserted,  is not displayed and pictures stored on the memory card will be displayed.

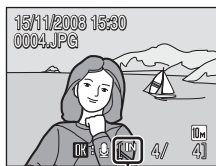
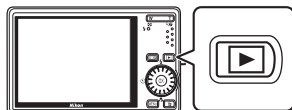



Internal memory indicator

Deleting Pictures

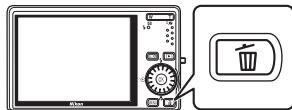
- 1 Press the  button to delete the picture currently displayed in the monitor.







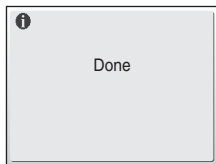
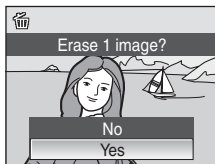





- 2 Use the rotary multi selector to select **Yes** and press the  button.

To exit without deleting the picture, select **No** and press the  button.







Options Available in Playback Mode



The following options are available in full-frame playback mode.

Option	Use	Description	
Playback zoom	T 	Press the T  button to enlarge view of picture currently displayed, up to about 10x. Press the OK  button to return to full-frame playback mode.	52
View thumbnails	W 	Press the W  button to display 9, 16, or 25 picture thumbnails.	51
Record/play voice memo	OK 	Press the OK  button to record or play back voice memos up to 20 seconds in length.	57
Switch to shooting mode		Press the  button to switch to the shooting mode selected in the shooting-mode selection menu.	28

Pressing the Button to Turn On the Camera

- When the camera is off, holding down the  button will turn the camera on in playback mode. The lens will not extend.
- If the camera is turned off in voice recording mode ( 64) or sound file playback mode ( 66), pressing the  button will turn the camera on in sound file playback mode.

Viewing Pictures

- Pictures stored in the internal memory can only be viewed if no memory card is inserted.
- When pictures in which a face was detected during shooting ( 92) are displayed in full-frame playback, the pictures may be automatically rotated for playback display, depending upon the orientation of the detected face.
- When the monitor has turned off in standby mode to save power, press the power switch or the shutter-release button to reactivate it ( 112).

Deleting the Last Picture Taken

In shooting mode, press the  button to delete the last picture taken.

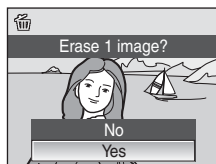

Deleting Multiple Pictures

Multiple pictures can be deleted by selecting **Delete** ( 98) from the playback menu ( 95) or the list by mode menu ( 60).

Using the Flash

The flash has a range of about 0.5–8.0 m (1.6–26.2 ft.) when the camera is zoomed out all the way. With maximum optical zoom applied, the range is about 0.5–3.5 m (1.6–11.4 ft.) (when **ISO sensitivity** is set to **Auto**). The following flash modes are available.

Auto

Flash fires automatically when lighting is poor.

Auto with red-eye reduction

Reduces “red-eye” in portraits ( 31).

Off

Flash will not fire even when lighting is poor.

Fill flash

Flash fires when a picture is taken. Use to “fill-in” (illuminate) shadows and backlit subjects.

Slow sync

 (auto) is combined with slow shutter speed. Flash illuminates main subject; slow shutter speeds are used to capture background at night or under dim light.

Setting the Flash Mode

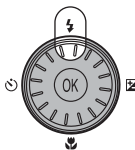

1 Press (flash mode).

The flash mode menu is displayed.



2 Use the rotary multi selector to choose the desired flash mode and press the button.

The icon for the selected flash mode is displayed at the top of the monitor.

 will disappear after a few seconds, regardless of the **Photo info** option ( 107).

If a setting is not applied by pressing the  button within a few seconds, the selection will be cancelled.

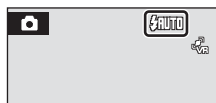
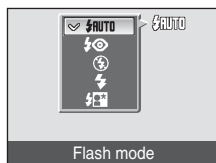

✓ Shooting When Lighting is Poor and the Flash is Disabled (🔇)

- Use of a tripod is recommended to stabilize the camera during shooting and avoid the effects of camera shake. Turn vibration reduction (🔇 109) off when using a tripod.
- The **ISO** indicator is displayed when the camera automatically increases sensitivity. Pictures taken when **ISO** is displayed may be slightly mottled.
- When **ISO** is displayed and higher sensitivity is applied, noise reduction may be automatically applied as pictures taken are recorded; results in increased recording times.

✓ Note on Using the Flash

When using the flash, reflections from dust particles in the air may appear as bright spots in pictures. To reduce these reflections, set the flash mode to (🔇) (Off).

🔧 The Flash Lamp

The flash lamp indicates flash status when the shutter-release button is pressed halfway.

- **On:** Flash will fire when picture is taken.
- **Blinks:** Flash charging. Wait a few seconds and try again.
- **Off:** Flash will not fire when picture is taken.

If the battery is low, the monitor display will turn off, and remain off, until the flash is fully charged.

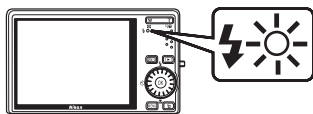

🔧 The Flash Mode Setting

The default flash mode setting varies with shooting mode.

- 📷 (auto) mode: 🔄AUTO Auto
- 📖 (scene): varies with the selected scene mode (🔍 36)
- 📖 (scene auto selector): 🔄AUTO Auto. The camera selects the flash mode depending upon the selected scene mode it has automatically selected (🔍 45).
- 🧒 (active child): (🔇) Off
- 😊 (smile): 🔄AUTO Auto

The flash mode setting applied in 📷 (auto) mode is stored in the camera's memory even after the camera is turned off, and reapplied the next time 📷 (auto) mode is selected.

🔧 Red-Eye Reduction

This camera uses advanced red-eye reduction ("In-Camera Red-Eye Fix"). The flash fires repeatedly at low intensity before the main flash, reducing red-eye. The camera then analyzes the picture; if red-eye is detected, the affected area will be processed to further reduce red-eye before the picture is saved. Note that because there is a slight lag between the shutter-release button being pressed and the picture being shot, this mode is not recommended when a quick shutter response is required. The time before the next picture can be shot also increases slightly. Advanced red-eye reduction may not produce the desired results in all situations. In extremely rare instances, areas not subject to red-eye may be affected by advanced red-eye reduction processing; in these cases, choose another mode and try again.

Taking Pictures with the Self-Timer

The camera is equipped with a ten-second and two-second timer for self-portraits. When using the self-timer, use of a tripod is recommended. Turn vibration reduction ( 109) off when using a tripod.

1 Press (self-timer).

The self-timer menu is displayed.

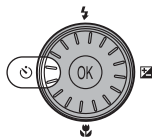

2 Use the rotary multi selector to choose **10s** or **2s** and press the button.

10s (ten seconds): suited for important occasions (such as weddings)

2s (two seconds): suited for preventing camera shake

The mode selected for self-timer is displayed.

If a setting is not applied by pressing the  button within a few seconds, the selection will be cancelled.



3 Frame the picture and press the shutter-release button halfway.

Focus and exposure will be set.

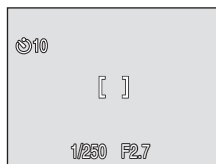

4 Press the shutter-release button the rest of the way down.

The self-timer starts and the number of seconds remaining until the shutter is released is displayed in the monitor. The self-timer lamp will blink. The lamp stops blinking one second before the picture is taken and remains lit until the shutter is released.

When the shutter is released, the self-timer turns off.

To stop the timer before a picture is taken, press the shutter-release button again.

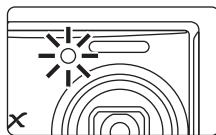
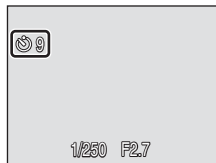

Macro Mode

Macro mode is used for taking pictures of objects as close as 3 cm (1.2 in.). Note that the flash may be unable to light entire subject at distances of less than 50 cm (1 ft. 8 in.).

1 Press (macro mode).

The macro mode menu is displayed.

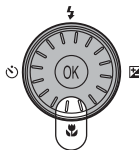



2 Use the rotary multi selector to choose **ON** and press the button.

The macro mode icon () is displayed.

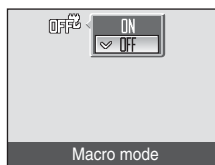
If a setting is not applied by pressing the  button within a few seconds, the selection will be cancelled.



3 Press the **T** () button or the **W** () button to frame the picture.

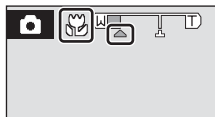

The camera can focus at a distance of 3 cm (1.2 in.) at the zoom position at which  and the zoom indicator glow green (the zoom indicator is before .



Macro Mode

- If macro mode is turned on in scene modes indicated below, **Autofocus mode** ( 93) will be automatically set to **Full-time AF**.
 - **Beach/snow**
 - **Close-up** (the macro mode setting is fixed at **ON**)
 - **Food** (the macro mode setting is fixed at **ON**)
 - **Museum**
 - **Copy**
 - **Panorama assist**
- In **Full-time AF**, the camera automatically focuses continuously until focus and exposure are locked by pressing the shutter-release button halfway.

The Macro Mode Setting

The macro mode setting applied in  (auto) mode is stored in the camera's memory even after the camera is turned off, and reapplied the next time  (auto) mode is selected.

Exposure Compensation

Exposure compensation is used to alter exposure from the value suggested by the camera to make pictures brighter or darker.

1 Press (exposure compensation).

The exposure compensation guide is displayed.

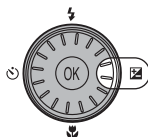

2 Use the rotary multi selector to adjust exposure and press the button.

- When the subject is too dark: adjust the exposure compensation to "+" side.
- When the subject is too bright: adjust the exposure compensation to "-" side.
- Exposure compensation can be set to values between -2.0 and +2.0 EV.
- If a setting is not applied by pressing the  button within a few seconds, the selection will be cancelled.

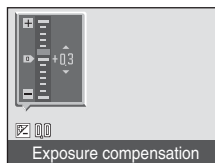

3 The setting is applied.

The value is displayed with the  icon in the monitor.



Exposure Compensation Value

The exposure compensation value applied in  (auto) mode is stored in the camera's memory even after the camera is turned off, and reapplied the next time  (auto) mode is selected.

Using Exposure Compensation

The camera tends to lower exposure when the frame is dominated by brightly lit objects and to increase exposure when the frame is mostly dark. Positive compensation may therefore be required to capture the brilliancy of very bright objects that fill the frame (for example, sunlit expanses of water, sand, or snow) or when the background is much brighter than the main subject. Negative compensation may be called for when large areas of the frame contain very dark objects (for example, a swath of dark green leaves) or when the background is much darker than the main subject.

Shooting in Scene Mode

Camera settings are automatically optimized for the selected subject type. The following scene modes are available.

Portrait	Party/indoor	Night landscape	Fireworks show
Landscape	Beach/snow	Close-up	Copy
Sports	Sunset	Food	Backlight
Night portrait	Dusk/dawn	Museum	Panorama assist

Setting the Scene Mode

- 1 Enter scene mode by pressing the **MODE** button in shooting mode, selecting **SCENE** (use the rotary multi selector), and then pressing the **OK** button.



- 2 Press the **MENU** button to display the scene menu screen, and choose the desired scene and press the **OK** button.

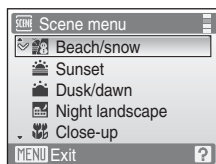

- 3 Frame the subject and take the picture.



Image Mode

Image mode (83) can be set in the scene menu. Changes made to the image mode setting apply to all shooting modes (except those available from the movie menu).

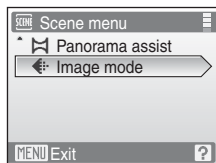

Features

Portrait

NR

Use this mode for portraits in which the main subject stands out clearly. Portrait subjects exhibit smooth, natural-looking skin tones.

- The camera detects and focuses on a face looking toward the camera (Shooting with Face Priority →  92).
- If the camera detects multiple faces, the camera focuses on the face closest to the camera.
- If no face is recognized, the camera will focus on the subject in center of frame.
- Digital zoom is not available.





* Other settings can be selected.

Landscape

NR

Use this mode for vivid landscapes and cityscapes.



- Camera focuses at infinity. When the shutter-release button is pressed halfway, the focus area or focus indicator ( 6) always lights green; however, focus may not be set for near subjects, while the camera focuses at infinity.
- The AF-assist illuminator does not light, regardless of the AF assist setting ( 110).



* Other settings can be selected.

Sports

Use this mode for dynamic action shots that freeze the action in a single shot and record motion in a series of pictures.









- The camera focuses continuously until focus is locked by pressing the shutter-release button halfway.
- While the shutter-release button is held down, pictures are taken at rate of up to about 1.0 frames per second (fps) when image mode is set to  **Normal (3648)**. Shooting ends when the shutter-release button is released, or ten shots have been taken with the shutter-release button held down.
- The maximum frame rate with continuous shooting may vary depending upon the current image mode setting and the memory card used.
- The AF-assist illuminator does not light, regardless of the AF assist setting ( 110).



* Other settings can be selected.

 Pictures taken in scene modes utilizing  may be processed to reduce noise and therefore take longer to record.

Icons Used for Descriptions

The following icons are used for descriptions in this section: , flash mode ( 30); , self-timer ( 32); , macro mode ( 33); , exposure compensation ( 34).

Night portrait



Use this mode to achieve a natural balance between the main subject and background lighting in portraits taken at night.

- The camera detects and focuses on a face looking toward the camera (Shooting with Face Priority →  92).
- If the camera detects multiple faces, the camera focuses on the face closest to the camera.
- If no face is recognized, the camera will focus on the subject in center of frame.
- Digital zoom is not available.



¹ Fill flash with slow sync and red-eye reduction.

² Other settings can be selected.

Party/indoor



Captures the effects of candlelight and other indoor background lighting.

- Camera focuses on subject in center of frame.
- Hold the camera steadily as pictures are easily affected by camera shake. When shooting under low lighting, use of a tripod is recommended. Set **Vibration reduction** ( 109) to **Off** when using a tripod.



¹ Fill flash with slow sync and red-eye reduction. Other settings can be selected.

² Other settings can be selected.

Beach/snow







Captures the brightness of such subjects as snowfields, beaches, or sunlit expanses of water.

- Camera focuses on subject in center of frame.



* Other settings can be selected.

: For those scene modes with , use of a tripod is recommended. Set **Vibration reduction** ( 109) to **Off** when using a tripod.

: Pictures taken in scene modes utilizing  may be processed to reduce noise and therefore take longer to record.

Shooting in Scene Mode

Sunset



Preserves the deep hues seen in sunsets and sunrises.

- Camera focuses at infinity. When the shutter-release button is pressed halfway, the focus area or focus indicator (AF 6) always lights green; however, focus may not be set for near subjects, while the camera focuses at infinity.
- The AF-assist illuminator does not light, regardless of the AF assist setting (AF 110).



Off*



Off



0.0*

* Other settings can be selected.

Dusk/dawn



Preserves the colors seen in the weak natural light before sunrise or after sunset.

- Camera focuses at infinity. When the shutter-release button is pressed halfway, the focus area or focus indicator (AF 6) always lights green; however, focus may not be set for near subjects, while the camera focuses at infinity.
- The AF-assist illuminator does not light, regardless of the AF assist setting (AF 110).



Off*



Off



0.0*

* Other settings can be selected.

Night landscape



Slow shutter speeds are used to produce stunning night landscapes.

- Camera focuses at infinity. When the shutter-release button is pressed halfway, the focus area or focus indicator (AF 6) always lights green; however, focus may not be set for near subjects, while the camera focuses at infinity.
- The AF-assist illuminator does not light, regardless of the AF assist setting (AF 110).



Off*



Off



0.0*

* Other settings can be selected.

: For those scene modes with , use of a tripod is recommended. Set **Vibration reduction** (AF 109) to **Off** when using a tripod.

: Pictures taken in scene modes utilizing may be processed to reduce noise and therefore take longer to record.

Close-up

NR

Photograph flowers, insects, and other small objects at close range.

- Macro mode (33) will be turned on and the camera automatically zooms to the position at the closest distance at which the camera can focus.
- The camera can focus at distances as close as 3 cm (1.2 in.) at the wide-angle zoom position at which the icon glows green (the zoom indicator is before \triangle). The closest distance at which the camera can focus varies depending upon zoom position.
- **AF area mode** is set to **Manual** (90). Press the OK button to choose the focus area in which focus is acquired.
- The camera focuses continuously until focus is locked by pressing the shutter-release button halfway.
- As pictures are easily affected by camera shake, check the **Vibration reduction** (109) and **Motion detection** (110) settings and hold the camera steadily.



* Other settings can be selected. Note that when shooting with the flash, the flash may be unable to light entire subject at distances of less than 50 cm (1 ft. 8 in.)

Food

NR

Use when taking pictures of food. See "Taking Pictures in Food Mode" (41) for details.

- **AF area mode** is set to **Manual** (90). Press the OK button to choose the focus area in which focus is acquired.



* Other settings can be selected.

Museum

Use indoors where flash photography is prohibited (for example, in museums and art galleries) or in other settings in which you do not want to use the flash.

- Camera focuses on subject in center of frame.
- **BSS** (Best Shot Selector) (88) is used when shooting.
- As pictures are easily affected by camera shake, check the **Vibration reduction** (109) and **Motion detection** (110) settings and hold the camera steadily.
- The AF-assist illuminator does not light, regardless of the AF assist setting (110).





* Other settings can be selected.

NR: Pictures taken in scene modes utilizing **NR** may be processed to reduce noise and therefore take longer to record.

Shooting in Scene Mode

Fireworks show

Slow shutter speeds are used to capture the expanding burst of light from a firework.

- Camera focuses at infinity. When the shutter-release button is pressed halfway, the focus indicator () 26) glows green; however, focus may not be set for near subjects, while the camera focuses at infinity.
- **Motion detection** () 110) is set to **Off**.
- The AF-assist illuminator does not light, regardless of the AF assist setting () 110).



Copy

Provides clear pictures of text or drawings on a white board or in print.

- Camera focuses on subject in center of frame.
- Use macro mode () 33) to focus at short ranges.
- Colored text and drawings may not show up well.



* Other settings can be selected.



Backlight

Use when light is coming from behind your subject, throwing features or details in shadow. The flash fires automatically to “fill in” (illuminate) shadows.

- Camera focuses on subject in center of frame.



* Other settings can be selected.

: For those scene modes with , use of a tripod is recommended. Set **Vibration reduction** () 109) to **Off** when using a tripod.

: Pictures taken in scene modes utilizing  may be processed to reduce noise and therefore take longer to record.

Panorama assist



Use when taking a series of pictures that will later be joined to form a single panorama using the supplied Panorama Maker software. See "Taking Pictures for a Panorama" (📷 43) for details.



* Other settings can be selected.

Taking Pictures in Food Mode

Use this mode to take pictures of food.

- Use the rotary multi selector to choose **Food** in the scene menu and press the **OK** button (📷 35).



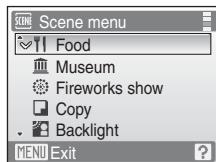



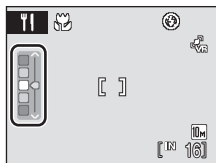





Macro mode (📷 33) will be turned on and the camera automatically zooms to the position at the closest distance at which the camera can focus.



- Press the rotary multi selector **▲** or **▼** to choose white balance.
 - Press **▲** to increase the amount of red, or **▼** to increase the amount of blue.



3 Frame the picture.

- The camera can focus at distances as close as 3 cm (1.2 in.) at the wide-angle zoom position at which  and the zoom indicator glow green (the zoom indicator is before ). The closest distance at which the camera can focus varies depending upon zoom position.
- As pictures are easily affected by camera shake, check the **Vibration reduction** ( 109) setting and hold the camera steadily.
- **AF area mode** is set to **Manual** ( 90). Press the  button to move the focus area. Press the rotary multi selector , , , or  to select a focus area and press the  button again to activate the selected focus area.
- Self-timer ( 32) and exposure compensation ( 34) settings can be adjusted while the focus area is locked.

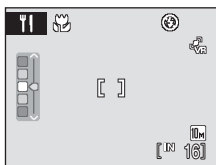
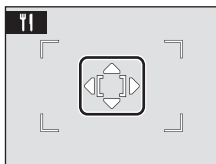

4 Press the shutter-release button to take the picture.

- Focus is locked when the shutter-release button is pressed halfway, and a picture is taken when the shutter-release button is pressed the rest of the way down.
- When the camera is unable to focus, the focus area blinks red. Change the composition and press the shutter-release button halfway again.

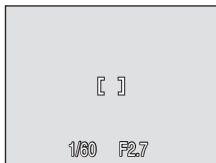

Notes on Food Mode

Flash mode is disabled. Macro mode setting ( 33) is fixed at **ON**.

White Balance Setting in Food Mode

- Increasing the amount of red or blue will decrease illumination effects.
- Changing white balance in food mode will not affect white balance in the shooting menu ( 85).
- The white balance setting applied in food mode is stored in the camera's memory even after the camera is turned off, and reapplied the next time food mode is selected.

Taking Pictures for a Panorama





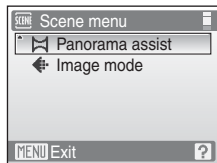

The camera focuses on the subject in the center of frame. Use a tripod for best results. Set **Vibration reduction** (📷 109) to **Off** when using a tripod to stabilize the camera during shooting.

- 1 Use the rotary multi selector to choose  **Panorama assist** in the scene menu and press the **OK** button (📷 35).

- The  icon is displayed to show the direction in which pictures will be joined.



- 2 Use the rotary multi selector to choose the direction and press the **OK** button.

- Select how pictures will be joined together in the completed panorama; right () , left () , up () or down () .
- The yellow panorama direction icon () will move to the direction pressed and press the **OK** button to choose the direction. A white panorama direction icon () will be displayed in the chosen direction.
- Apply flash mode (📷 30), self-timer (📷 32), macro mode (📷 33) and exposure compensation (📷 34) settings with this step, if necessary.
- Press the **OK** button to reselect the direction.



- 3 Shoot the first picture.

- The picture taken will be displayed in 1/3 of the monitor.



- 4 Shoot the second picture.

- Compose the next picture so that it overlaps the first picture.
- Repeat until you have taken the necessary number of pictures to complete the scene.

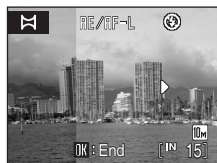

5 Press the **OK** button when shooting is completed.

The camera returns to step 2.



✓ Panorama Assist

Flash mode, self-timer, macro mode and exposure compensation settings cannot be adjusted after the first picture is taken. Pictures cannot be deleted, nor can zoom or image mode setting (📷 83) be adjusted until the series is finalized.

The panorama series is terminated if the camera enters standby mode with the auto off function (📷 112) during shooting. Setting the time allowed to elapse before the auto off function is enabled to a longer setting is recommended.

📷 The AE/AF-L Indicator

AE/AF-L is displayed to indicate that white balance, exposure, and focus have been locked at the values set with the first shot. All pictures taken in a panorama series have the same focus, exposure, and white-balance settings.



📷 Image File Names and Folder Names

Files are stored in folders named with a folder number followed by "P_" plus a three-digit sequence number for pictures taken using panorama assist (e.g., "101P_001"). File numbers will be assigned automatically starting with "0001".

📷 Panorama Maker

Install Panorama Maker from the supplied Software Suite CD-ROM. Transfer pictures to a computer (📷 70) and use Panorama Maker (📷 73) to join them in a single panorama.

Shooting in the Scene Mode Selected by the Camera (Scene Auto Selector)

By simply framing a picture, the camera automatically selects the optimum scene mode for simpler shooting.

When the camera is aimed at a subject in  scene auto selector mode, the camera automatically selects one of the following scene modes:

- **Auto** ( 22)
- **Portrait** ( 36)
- **Landscape** ( 36)
- **Night portrait** ( 37)
- **Night landscape** ( 38)
- **Close-up** ( 39)
- **Backlight** ( 40)

For more information regarding details of these scene modes, see the reference pages indicated above.

Taking Pictures in Scene Auto Selector Mode

- 1 Enter scene auto selector mode by pressing the **MODE** button in shooting mode, selecting  (use the rotary multi selector), and then pressing the **OK** button.

The camera enters scene auto selector mode.



- 2 Frame the subject and take the picture.

When the camera automatically selects a scene mode, the shooting mode icon changes to that for the scene mode currently enabled.



- | | |
|--|---|
|  : Auto |  : Night landscape |
|  : Portrait |  : Close-up |
|  : Landscape |  : Backlight |
|  : Night portrait | |





Press the shutter-release button halfway to set focus and exposure.



Press the shutter-release button the rest of the way down to take the picture.

Notes on Scene Auto Selector Mode



Depending upon shooting conditions, the camera may not select the desired scene mode. Should this occur, switch to  (auto) mode ( 22) or select the desired scene mode manually ( 35).

Flash Mode in Scene Auto Selector Mode

 **AUTO** (Auto) (default setting) and  (Off) flash mode settings can be applied ( 30).

- When  **AUTO** (Auto) is applied, the camera automatically selects the optimum flash mode setting for the scene mode it has selected.
- When  (Off) is applied, the flash does not fire, regardless of shooting conditions.



Functions Restricted in Scene Auto Selector Mode

- When the **MENU** button is pressed in scene auto selector mode, only the **Image mode** menu is displayed. Changes made to the image mode setting in this mode apply to all shooting modes (except those available from the movie menu).
- Digital zoom is not available.
- The macro mode button on the rotary multi selector ( 9, 33) is disabled.
- The **AF area mode** setting ( 90) is set to **Auto** in  (Close-up) mode.

Active Child Mode

Use this mode to shoot moving subjects. Once the subject has been selected, the focus area will automatically follow the subject.

- 1 Enter active child mode by pressing the **MODE** button in shooting mode, selecting  (use the rotary multi selector), and then pressing the **OK** button.

- A white border is displayed in the center of the monitor.
- Flash mode  30 is set to  (Off) (the setting can be changed).



- 2 Select a subject.

- Frame the subject in the center of the border and press the **OK** button.
 - The subject is selected and will be framed by a yellow double border.
 - When the camera is unable to focus on the subject, the single border will glow red. Change the composition and try again.
- Once the selected subject is not visible on the monitor, the double border will disappear and the selection will be cancelled. Select the subject again.

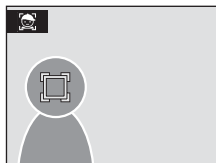

- 3 Press the shutter-release button halfway.

- The camera focuses on the focus area framed by the double border. The double border will glow green and focus will be locked.
- When the camera is unable to focus, the double border will blink. Press the shutter-release button halfway again and focus.
- If the shutter-release button is pressed halfway while the double border is not displayed, the camera focuses on the subject at the center of the frame.

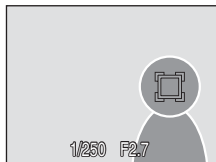

- 4 Press the shutter-release button the rest of the way down.

- The picture will be recorded to the memory card or internal memory.



Active Child Mode

- Do not adjust flash mode and exposure compensation settings after selecting the subject. If any setting is adjusted after selection of the subject, the selection of the subject will be cancelled. Deleting pictures, adjusting zoom or image mode settings (🔑 83) will also cancel the selection of the subject.
- In some situations, such as when the subject is moving rapidly, the camera may be unable to track the selected subject.
- In some rare cases shooting subjects with which autofocus may not perform as expected (🔑 27), the subject may not be in focus despite the fact that the double border glows green. Should this occur, switch to  (auto) mode and set **AF area mode** to **Manual** or **Center**, refocus on another subject positioned at the same distance from the camera as the actual portrait subject, and use focus lock (🔑 91).

Functions Available in Active Child Mode

- Digital zoom is not available.
- Flash mode (🔑 30) and exposure compensation (🔑 34) settings can be adjusted.
- When the **MENU** button is pressed in active child mode, only the **Image mode** menu (🔑 83) is displayed. Changes made to the image mode setting in this mode apply to all shooting modes (except those available from the movie menu).

Shooting in Smile Mode

The camera detects a smiling face to shoot the face automatically.

- 1 Enter smile mode by pressing the **MODE** button in shooting mode, selecting  (use the rotary multi selector), and then pressing the **OK** button.



- 2 Frame a picture.

- Point the camera at the subject.
- When the camera detects a face looking toward the camera, the focus area containing the face will be displayed with a yellow double border. The camera focuses on the face framed by the double border. The double border will glow green and focus will be locked.
- When the camera detects more than one face, the closest face is framed by a double border and the others by single borders. Up to three faces can be detected.



- 3 The shutter is automatically released.

- If the camera detects that the face framed by the double border is smiling, the shutter is automatically released.
- When the shutter is released, automatic shooting, with which the camera detects a smiling face and releases the shutter automatically, will be performed repeatedly.
- When the camera detects a face, the self-timer lamp () 4 blinks. Immediately after the shutter is released with detection of a smiling face, the self-timer lamp flickers.

- 4 Exit smile mode by pressing the **MODE** button.

- Switch to another shooting mode.
- The camera will stop shooting if the internal memory or memory card becomes full.



Smile Mode

The auto off function () 112 will be activated and the camera will turn off if no operations are performed in any of the following situations in smile mode.

- The camera is unable to detect one or more faces.
- The camera has detected one or more faces, but is unable to detect a smiling face.

Face Priority and Smiling Face Detection Features

When the camera is pointed at a face looking toward the camera in smile mode, the face is automatically recognized and the smiling face of the recognized one is detected.

- In some shooting conditions, Face priority will not take effect and smiling face cannot be detected.
- See “Shooting with Face Priority” (📖 92) for more information about Face Priority.

Operation of the Shutter-Release Button

Press the shutter-release button to take pictures.

- When a face is detected, the focus is locked to the detected face.
- If no face is detected, the camera focuses on the subject in center of frame.

Functions Available in Smile Mode

- Flash mode (📖 30) and exposure compensation (📖 34) settings can be adjusted.
- Digital zoom is not available.
- When the **MENU** button is pressed in smile mode, only the **Image mode** menu (📖 83) is displayed. Changes made to the image mode setting in this mode apply to all shooting modes (except those available from the movie menu).

More Information











For more information about shooting subjects with which autofocus may not perform as expected, see “Autofocus” (📖 27).

Viewing Multiple Pictures: Thumbnail Playback



Press the **W** () button in full-frame playback mode ( 28) to display pictures in “contact sheets” of thumbnail images.



The following operations can be performed while thumbnails are displayed.

To	Use	Description	
Choose pictures		Rotate the rotary multi selector, or press ◀, ▶, ▲, or ▼, to choose pictures.	9
Increase number of picture thumbnails displayed	W ()	Press the W () button to increase number of picture thumbnails displayed: 9 → 16 → 25	-
Decrease number of picture thumbnails displayed	T ()	Press the T () button to decrease number of picture thumbnails displayed: 25 → 16 → 9	-
Return to full-frame playback		Press the  button.	28
Switch to shooting mode		Press the  button to return to the last shooting mode selected.	28

Thumbnail Playback Mode Display

When print set ( 80) and protected pictures ( 98) are selected in thumbnail playback mode, the icon shown at right is displayed with them. Movies are displayed as film frames in all thumbnail playback modes.

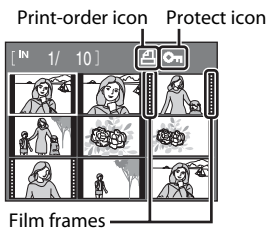

Taking a Closer Look: Playback Zoom

Pressing the **T** (Q) button during full-frame playback mode (3 28) zooms the current picture, with the center of the picture displayed in the monitor.

The guide at lower right shows which portion of the picture is enlarged.



The following operations can be performed while pictures are zoomed in.

To	Use	Description	3
Zoom in	T (Q)	Zoom increases each time the T (Q) button is pressed, to a maximum of 10x.	–
Zoom out	W (3)	Zoom decreases each time the W (3) button is pressed. When the magnification ratio reaches 1x, the display returns to full-frame playback mode.	–
Move the display area		Press the rotary multi selector ▲, ▼, ◀, or ▶ to move the display area to other areas of the picture.	9
Return to full-frame playback	OK	Press the OK button.	28
Crop picture	MENU	Press the MENU button to crop current picture to contain only the portion visible in the monitor.	55
Switch to shooting mode		Press the button to return to the last shooting mode selected.	28

Pictures Taken Using the Face-Priority Function

When zooming in (playback zoom) on a picture taken using the face-priority function, the picture will be enlarged with the face detected with shooting at the center of the monitor.

- If more than one face was detected, the picture will be enlarged with the face on which focus was acquired at the center of the monitor. Press the rotary multi selector ▲, ▼, ◀, or ▶ to display other faces that were detected.
- When the **T** (Q) or **W** (3) button is pressed to adjust the zoom ratio, the center of the picture (normal playback zoom display), rather than the face, is displayed at the center of the monitor.

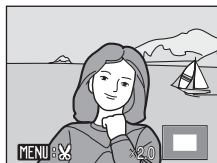

Editing Pictures

Use this camera to edit pictures in-camera and store them as separate files (📷 117).

Editing function	Description
D-Lighting (📷 54)	Create a copy of the current picture with enhanced brightness and contrast, brightening dark portions of the picture.
Crop (📷 55)	Enlarge the image or refine the composition and create a copy containing only the portion visible in the monitor.
Small picture (📷 56)	Create a small copy of pictures suitable for use on web pages or as e-mail attachments.

Picture Editing

- Pictures taken at an image mode setting of 📷 16:9 (3584) or 📷 16:9 (1920) (📷 83) cannot be edited.
- This camera's editing functions cannot be used for pictures taken with another make or model of camera.
- If a copy created using this camera is viewed on another make or model of camera, the picture may not be displayed or may not be transferred to a computer.
- Editing functions are not available when there is not enough free space in the internal memory or on the memory card.

Restrictions on Picture Editing

(✓: available, -: not available)

1st editing	2nd editing		
	D-Lighting	Crop	Small picture
D-Lighting	-	✓	✓
Crop	-	-	-
Small picture	-	-	-

- Pictures cannot be edited twice with the same editing function.
- The D-Lighting should be done first while the restricted use of combination exists.

Original Pictures and Edited Copies

- Copies created with editing functions are not deleted if the original pictures are deleted. The original pictures are not deleted if copies created with editing functions are deleted.
- Edited copies are stored with the same recording date and time as the original.
- Edited copies are not marked for printing (📷 80) or protecting (📷 98) as the original.

Enhancing Brightness and Contrast: D-Lighting

D-Lighting can be used to create copies with enhanced brightness and contrast, brightening dark portions of a picture. Enhanced copies are stored as separate files.

- 1 Select the desired picture from full-frame (📷 28) or thumbnail (📷 51) playback mode and press the **MENU** button.

The playback menu will be shown.

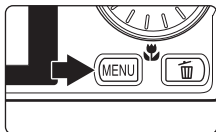

- 2 Use the rotary multi selector to choose **D-Lighting** and press the **OK** button.

The original version will be shown on the left and the edited version will be shown on the right.

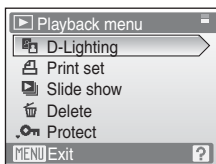

- 3 Choose **OK** and press the **OK** button.

A new copy with enhanced brightness and contrast is created.

To cancel D-Lighting, choose **Cancel** and press the **OK** button.

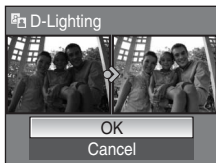

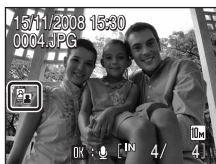

D-Lighting copies can be recognized by the  icon displayed during playback.



More Information

See "Image/Sound File and Folder Names" (📷 117) for more information.

Creating a Cropped Copy: Crop

Create a copy containing only the portion visible in the monitor when **MENU**  is displayed with playback zoom ( 52) enabled. Cropped copies are stored as separate files.

1 Press the **T** () button in full-frame playback mode to zoom in on the image.



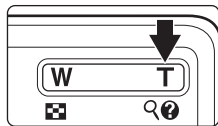

To crop a picture displayed in "tall" (portrait) orientation, zoom in on the picture until the black bars displayed on the both sides of the monitor disappear. The cropped picture will be displayed in landscape orientation.

To crop the picture in its current "tall" (portrait) orientation, first, use the **Rotate image** option () 99) to rotate the picture so that it is displayed in landscape orientation. Next, enlarge the picture for cropping, crop the picture, and then rotate the cropped picture back to "tall" (portrait) orientation.



2 Refine crop composition.

Press the zoom buttons, the **T** () or **W** () button, to adjust the zoom ratio.

Press the rotary multi selector , , , or  to scroll the picture until only the portion you want to copy is visible in the monitor.



3 Press the **MENU** button.

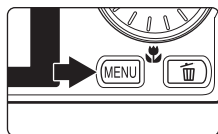



4 Use the rotary multi selector to choose **Yes** and press the **OK** button.

A new picture, containing only the portion visible in the monitor, is created.

To cancel creating a cropped copy, choose **No** and press the **OK** button.



Image Size



As the area to be saved is reduced, the image size (pixels) of the cropped copy is also reduced. When the size of the cropped copy is 320 × 240 or 160 × 120, the small picture icon  or  is displayed on the left of the screen in full-frame playback mode.



More Information

See "Image/Sound File and Folder Names" () 117) for more information.

Resizing Pictures: Small Picture

Create a small copy of the current picture. Small copies are stored as JPEG files with a compression ratio of 1:16. The following sizes are available.

Option	Description
 640×480	Suited to television playback.
 320×240	Suited to display on web pages.
 160×120	Suitable for e-mail attachments.

- 1 Select the desired picture from full-frame ( 28) or thumbnail ( 51) playback mode and press the **MENU** button.

The playback menu is displayed.

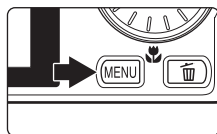

- 2 Use the rotary multi selector to choose **Small pic.** and press the **OK** button.

To cancel creating a small copy and return to shooting mode, press the **MENU** button.

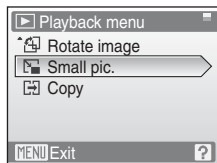

- 3 Choose the desired copy size and press the **OK** button.

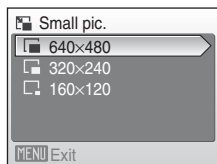

- 4 Choose **Yes** and press the **OK** button.

A new, smaller copy is created.

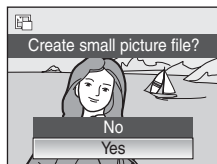

To cancel creating a small copy, choose **No** and press the **OK** button.



More Information

See "Image/Sound File and Folder Names" ( 117) for more information.

Voice Memos: Recording and Playback

Use the camera's built-in microphone to record voice memos for pictures marked with **OK**  in full-frame playback mode ( 28).

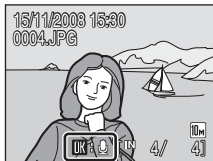

Recording Voice Memos

A voice memo, up to 20 seconds in length, will be recorded while the **OK** button is held down.

- Do not touch the built-in microphone during recording.
- During recording, **REC** and  blink in the monitor display.

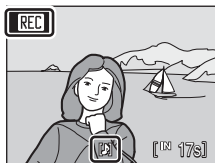



Playing Voice Memos

Press the **OK** button while a picture with a voice memo attached is displayed in full-frame playback mode to play voice memo. Playback ends when the voice memo ends or the **OK** button is pressed again.

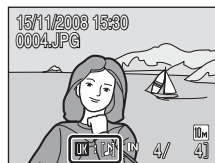
- Pictures with voice memos can be recognized by the **OK**  icon.
- Use the zoom buttons, the **T** or **W** button, to adjust playback volume.



Deleting Voice Memos

Select a picture with a voice memo attached and press the  button. Use the rotary multi selector to choose  and press the **OK** button. Only the voice memo will be deleted.

Voice Memos

- When a picture with a voice memo attached is deleted, both the picture and its voice memo are deleted.
- If a voice memo already exists for the current picture, a new voice memo cannot be recorded. To modify the existing voice memo, delete only the existing voice memo and then record a new voice memo.
- This camera cannot be used to attach voice memos to pictures taken with another make or model of camera.

More Information

See "Image/Sound File and Folder Names" ( 117) for more information.

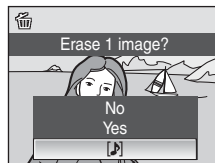

Viewing Pictures by Date

In list by date mode, pictures taken on a specified date can be displayed. In full-frame playback mode, just as with playback mode, picture display can be enlarged, pictures can be edited, voice memos can be recorded or played back, and movies can be played back. When the **MENU** button is pressed, the list by date menu is displayed, and all pictures taken on a specified date can be selected for deletion, printing, and protection.

Selecting a Date in List by Date Mode

- 1 Enter list by date mode by pressing the **MODE** button in playback mode, selecting **DATE** (use the rotary multi selector), and then pressing the **OK** button.

Dates for which pictures exist will be listed.

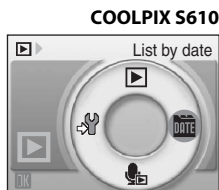

COOLPIX S610c



- 2 Choose the desired date and press the **OK** button.

Camera lists up to 29 dates. If pictures exist for more than 29 dates, all pictures recorded earlier than most recent 29 dates will be listed together as **Others**.

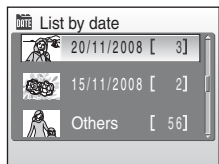





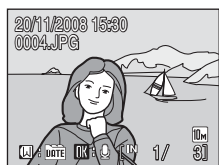

The first picture for that date will be displayed full-frame playback mode.

Press the **W** button in full-frame playback mode to return to the date list.



Using List by Date Mode

The following operations are possible from the date selection screen.

To	Use	Description	
Select date		Rotate the rotary multi selector, or press ▲ or ▼, to select a date.	9
Switch to full-frame playback		Press the OK button to display the first picture taken on the selected date. Press the W button in full-frame playback to return to the date selection screen.	29
Delete picture		Press the  button after selecting a date, and a confirmation dialog will be displayed. Choose Yes and press the OK button to delete all pictures taken on the selected date.	28
View list by date menu	MENU	Press the MENU button to display the list by date menu.	60
View playback mode menu	MODE	Press the MODE button to display the playback-mode selection menu.	8
Switch to shooting mode		Press the  button to return to the last shooting mode selected.	28

Notes on List by Date Mode

- Only the most recent 9,000 pictures can be displayed in list by date mode.
- Pictures taken with no date stamp are not listed in this mode.

List by Date Menus

Press the **MENU** button in list by date mode to display the following menus for only the pictures taken on the specified date.

D-Lighting*	 54
Print set	 80
Slide show	 97
Delete	 98
Protect	 98
Rotate image*	 99
Small picture*	 56

* During full-frame playback mode only

When the **MENU** button is pressed in the date selection screen ( 58), options can be applied to all pictures taken on the same date, or all pictures taken on the same date can be deleted. To apply options to individual pictures, or to select individual pictures for deletion, display a picture full-frame and press the **MENU** button.

Print Set

When print marking already exists for pictures taken on dates other than that specified, a confirmation dialog **Save print marking for other dates?** will be displayed. Select **Yes** to add the new print marking to the existing marking. Select **No** to remove the existing print marking and leave only the new marking.

Recording Movies

To shoot movies with sound recorded via the built-in microphone, select shooting mode and follow the steps below.

- 1 Enter movie mode by pressing the **MODE** button in shooting mode, selecting  (use the rotary multi selector), and then pressing the **OK** button.

Exposure count display shows maximum total length of movie that can be recorded.

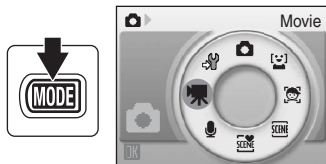

- 2 Press the shutter-release button all the way down to start recording.

The camera focuses on the subject in center of frame.





A progress bar at the bottom of the monitor shows the amount of recording time remaining.



To end recording, press the shutter-release button all the way down a second time.

Recording stops automatically when the internal memory or memory card becomes full, recording time reaches 30 minutes, or movie file size reaches 2 GB.

✓ Shooting Movies

- Flash mode ( 30), self-timer ( 32), and exposure compensation ( 34) cannot be applied or changed. Macro mode ( 33) is available.
- Macro mode setting cannot be applied or changed while movies are being recorded. Apply or change setting as necessary before movie recording begins.
- Optical zoom cannot be adjusted once movie recording begins. Digital zoom cannot be applied before movie recording begins. However, digital zoom (up to 2x) can be applied while movies are being recorded.

✓ Notes on Recording Movies

When the movie has been fully recorded to the internal memory or memory card, the monitor display will revert to the normal shooting mode display. **Do not open the battery-chamber/memory card slot cover** while movies are being recorded. Turning the camera off or removing the memory card while movies are being recorded could result in loss of data or in damage to the camera or card.

Changing Movie Settings

Movie options and autofocus mode settings can be changed in the movie menu ( 62).



The Movie Menu

Movie options and **Autofocus mode** (📷 62) settings can be changed in the movie menu.



Press the **MENU** button in movie mode to display the movie menu and use the rotary multi selector to modify and apply settings.

📷 Selecting Movie Options

The movie menu offers the options shown below.

Option	Image size and frame rate
 TV movie 640 (default setting)	Image size: 640 × 480 pixels Frame rate: 30 frames per second
 Small size 320	Image size: 320 × 240 pixels Frame rate: 30 frames per second

📷 Movie Options and Maximum Movie Length

Option	Internal memory (approx. 45 MB)	Memory card (256 MB)
 TV movie 640 (default setting)	32 s	Approx. 2 min 50 s
 Small size 320	1 min 22 s	Approx. 7 min 14 s

* All figures are approximate. The maximum recording time may vary with make of memory card.



This camera can record movies up to 30 minutes in length or a file size of up to 2 GB. The amount of recording time remaining (up to 30 minutes or 2 GB) is displayed during recording.

📷 More Information

See "Image/Sound File and Folder Names" (📷 117) for more information.

📷 Autofocus Mode

Choose how the camera focuses in movie mode.

Option	Description
 Single AF (default setting)	Camera focuses when shutter-release button is pressed halfway and locks at this position during shooting.
 Full-time AF	Camera focuses continuously until focus is acquired and locked. To prevent sound of camera focusing from interfering with recording, use of Single AF is recommended.

Movie Playback

In full-frame playback mode (F3 28), movies are recognized by the movie mode icons. To play a movie, display it in full-frame playback mode and press the OK button.

Use the zoom buttons, the T or W button, to adjust playback volume.

Playback controls appear at the top of the monitor. Press the rotary multi selector ◀ or ▶ to choose a control, then press the OK button to perform the selected operation. The following operations are available.

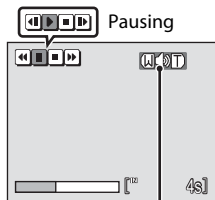

During playback
Volume indicator

To	Select	Description	
Rewind	◀	Rewind movie. Playback resumes when the OK button is released.	
Advance	▶	Advance movie. Playback resumes when the OK button is released.	
Pause	⏸	Pause playback. The following operations can be performed while playback is paused.	
		◀	Rewind movie by one frame. Rewind continues while the OK button is pressed.
		▶	Advance movie by one frame. Advance continues while the OK button is pressed.
Resume playback	▶	Resume playback.	
		▶	Resume playback.
End	■	End playback and return to full-frame playback.	

Deleting Movie Files

Press the button when displayed in full-frame playback mode (F3 28) or when selected in thumbnail (F3 51) playback mode. A confirmation dialog is displayed. Select **Yes** and press the OK button to delete the movie, or select **No** to exit without deleting the movie.

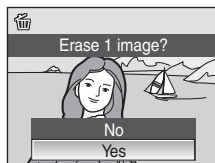

Making Voice Recordings

Audio voice recordings can be recorded over the built-in microphone and played back over the built-in speaker.

- 1 Enter voice recording mode by pressing the **MODE** button in shooting mode, selecting  (use the rotary multi selector), and then pressing the **OK** button.

The length of recording that can be made will be displayed.

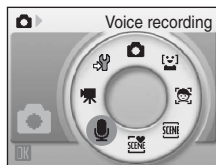

- 2 Press the shutter-release button all the way down to start recording.

The indicator lamp lights during recording.

If no operations are performed for about 30 seconds after voice recording begins, the camera's auto off function is enabled and the monitor turns off.

See "Operations During Recording" (📖 65) for more information.

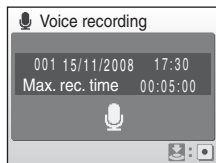

- 3 Press the shutter-release button all the way down a second time to end recording.





Recording will end automatically if the internal memory or memory card becomes full, or after 120 minutes of recording on the memory card.

More Information

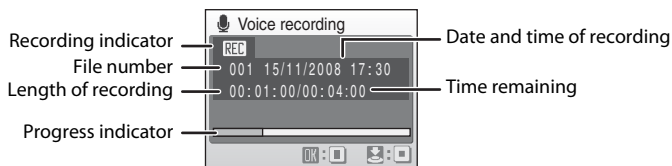
See "Image/Sound File and Folder Names" (📖 117) for more information.

Operations During Recording



To	Press	Description
Reactivate the monitor		If the monitor has turned off, press the  button to reactivate.
Pause/resume recording		Press once to pause recording; indicator lamp will blink.
End recording		Press the shutter-release button all the way down a second time to end recording.

Voice Recordings



The files transferred to a computer can be played back using QuickTime or any other WAV-compatible audio player.

More Information

See "Image/Sound File and Folder Names" ( 117) for more information.

Playing Voice Recordings

- 1 Enter sound file playback mode by pressing the **MODE** button in playback mode, selecting  (use the rotary multi selector), and then pressing the **OK** button.

Voice recordings can also be played back by pressing the  button in voice recording mode ( 64) to display the sound file selection screen.

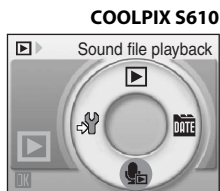

- 2 Choose the desired sound file and press the **OK** button.

The selected sound file will be played back.

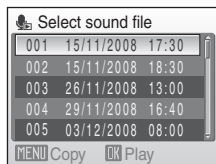

Operations During Playback

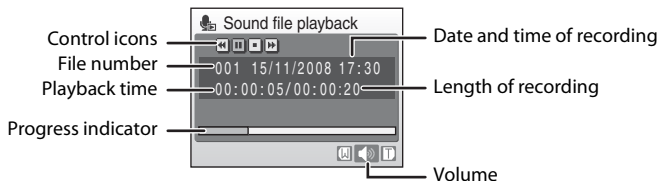

Use the zoom buttons, the **T** or **W** button, to adjust playback volume.

Playback controls appear at the top of the monitor. Press the rotary multi selector ◀ or ▶ to choose a control, then press the **OK** button to perform the selected operation. The following operations are available.

To	Press	Description
Rewind	◀	Rewind voice recording. Playback resumes when the OK button is released.
Advance	▶	Advance voice recording. Playback resumes when the OK button is released.
Pause	⏸	Pause playback.
	▶	Resume playback that has been paused.
End	■	End playback and return to the sound file selection screen.

Deleting Sound Files

Press the **Del** button during playback or after selecting a sound file from the sound file selection screen. A confirmation dialog is displayed. To delete the file, select **Yes** and press the **OK** button. To exit without deleting the sound file, select **No**.

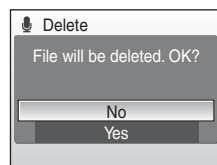

Copying Voice Recordings

Copy voice recordings between the internal memory and a memory card. This option is available only when a memory card is inserted.

- 1 Display the sound file selection screen shown in step 2 on page 66 and press the **MENU** button.

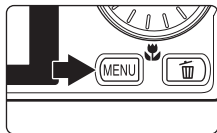

- 2 Use the rotary multi selector to choose the option and press the **OK** button.

: Copy recordings from internal memory to memory card

: Copy recordings from memory card to internal memory

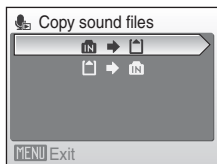

- 3 Choose the copy option and press the **OK** button.

Selected files: Proceed to step 4

Copy all files: Proceed to step 5

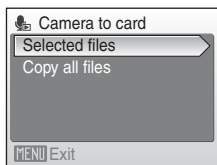

- 4 Choose the desired file.

Press the rotary multi selector to select the file (). Press the rotary multi selector again to cancel the selection.

- Multiple files can be selected.
- Press the **OK** button to finalize file selection.

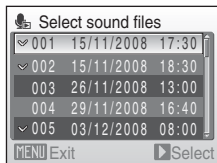

- 5 When a confirmation dialog is displayed, choose **Yes** and press the **OK** button.

Copying starts.

Voice Recordings

This camera may be unable to copy sound files created with another make or model of camera.

No sound file. Message

If there are no sound files stored on the memory card when is selected (66, step 1), the message, **No sound file.**, will be displayed. Press the **MENU** button to display the copy sound files screen, and copy the sound files stored in the camera's internal memory to the memory card.

Connecting to a TV

Connect the camera to a television using the supplied audio/video cable to play back pictures on the television.

1 Turn off the camera.

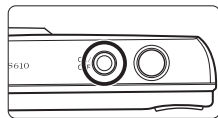

2 Connect the camera to the TV using the supplied audio/video cable.

Connect the yellow plug to the video-in jack on the TV, and the white plug to the audio-in jack.

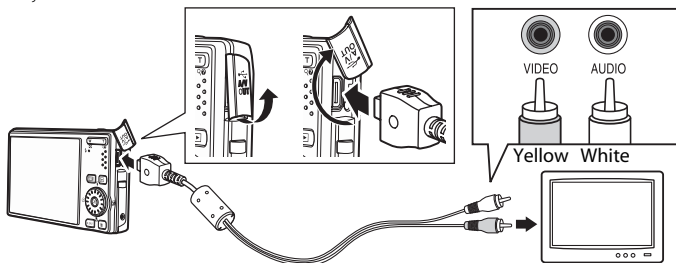

3 Tune the television to the video channel.

See the documentation provided with your television for details.

4 Hold down the button to turn on the camera.

The camera enters playback mode, and pictures recorded to the internal memory, or memory card, will be displayed on the television.

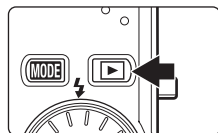

While connected to the TV, the camera monitor will remain off.



Connecting an Audio/Video Cable

When connecting the audio/video cable, be sure that the camera connector is oriented correctly. Do not use force when connecting the audio/video cable to the camera. When disconnecting the audio/video cable, do not pull the connector at an angle.

Video Mode

Be sure that the camera's video mode setting conforms to the standard used by your television. The video mode setting is an option set in the setup menu () 101> **Video mode** () 113).

Connecting to a Computer

Use the supplied USB cable to connect the camera to a computer, and copy (transfer) pictures to a computer with the supplied Nikon Transfer software.

Before Connecting the Camera

Install the Software

Before connecting the camera to a computer, software, including Nikon Transfer and Panorama Maker for creating panorama images, must be installed from the supplied Software Suite CD. For more information on installing the software, refer to the *Quick Start Guide*.

Operating Systems Compatible with the Camera

Windows

Preinstalled versions of 32-bit Windows Vista Service Pack 1 (Home Basic/Home Premium/Business/Enterprise/Ultimate editions), Windows XP Service Pack 3 (Home Edition/Professional)

Macintosh

Mac OS X (version 10.3.9, 10.4.11, 10.5.3)

Refer to the Nikon website for the latest information on operating system compatibility.

Note on Power Source

When connecting the camera to a computer or printer, use a fully charged battery to prevent the camera from turning off unexpectedly.

If You Are Using Windows 2000 Professional

- Do not connect the camera to the computer.
- Use a card reader or similar device to transfer pictures stored on the memory card to the computer ( 73).
- If the camera has been connected to the computer, the Found New Hardware Wizard dialog is displayed. Select **Cancel** to close the dialog and disconnect the camera from the computer.

Transferring Pictures from a Camera to a Computer

- 1 Start the computer to which Nikon Transfer was installed.
- 2 Turn off the camera.
- 3 Connect the camera to the computer using the supplied USB cable.

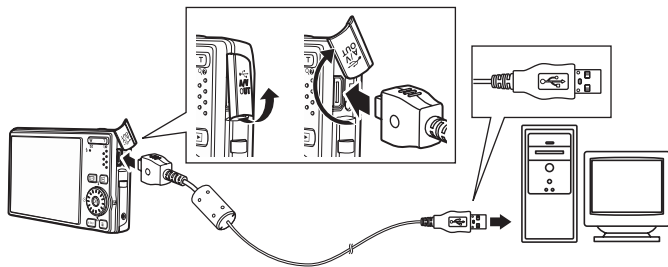

- 4 Turn on the camera.
The power-on lamp will light.

Windows Vista

When the AutoPlay dialog is displayed, click **Copy pictures to a folder on my computer using Nikon Transfer**. Nikon Transfer will start. To bypass this dialog in the future, check **Always do this for this device**.

Windows XP

When the action selection dialog is displayed, select **Nikon Transfer Copy pictures to a folder on my computer**, and click **OK**. Nikon Transfer will start. To bypass this dialog in the future, check **Always use this program for this action**.

Mac OS X

Nikon Transfer will start automatically if **Yes** was selected in the Auto-Launch setting dialog when Nikon Transfer was first installed.

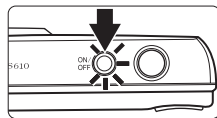

✓ Connecting the USB Cable

- When connecting the USB cable, be sure that the connectors are oriented correctly. Do not use force when connecting the USB cable. When disconnecting the USB cable, do not pull the connector at an angle.
- Connection may not be recognized when the camera is connected to a computer via a USB hub.

5 Transfer pictures when Nikon Transfer has finished loading.

Click **Start Transfer** in Nikon Transfer. At the default setting, all pictures are transferred to the computer.

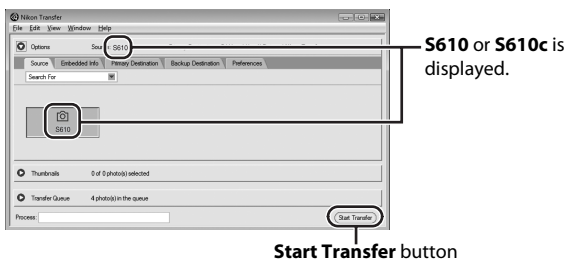

At the Nikon Transfer default setting, the folder to which pictures are transferred is automatically opened when transfer is complete.

If ViewNX has been installed, ViewNX will start automatically and transferred pictures can be viewed.

For more information on using Nikon Transfer, refer to help information contained in Nikon Transfer.

6 Disconnect the camera when transfer is complete.

Turn the camera off and disconnect the USB cable.

Using a Card Reader

The pictures stored on the memory card inserted into a card reader or similar device can also be transferred to the computer using Nikon Transfer.

- If the memory card has a capacity greater than 2 GB, or is SDHC-compliant, the intended device must support these features of the memory card.
- At the Nikon Transfer default settings, Nikon Transfer will start automatically when a memory card is inserted into the card reader or similar device. See step 5 of “Transferring Pictures from a Camera to a Computer” (🔗 72).
- To transfer pictures stored in the camera’s internal memory to the computer, the pictures must first be copied to a memory card using the camera (🔗 68, 100).

Using Standard OS Operations to Open Image/Sound Files

- Navigate to the folder on the computer’s hard disk to which pictures were saved and open a picture in the viewer supplied with your operating system.
- Sound files copied to the computer can be played back using QuickTime or any other WAV-compatible audio player.

Panorama Creation with Panorama Maker

- Use a series of pictures taken using the **Panorama assist** option in scene mode (🔗 43) to create a single panorama photo with Panorama Maker.
- Panorama Maker can be installed to a computer using the supplied Software Suite CD. After installation is complete, follow the procedure described below to start Panorama Maker.

Windows

Open **All Programs** (**Programs** under Windows 2000) from the **Start** menu>**ArcSoft Panorama Maker 4**>**Panorama Maker 4**.

Macintosh

Open Applications by selecting **Applications** from the **Go** menu, and double-click the **Panorama Maker 4** icon.

- For more information on using Panorama Maker, refer to the on-screen instructions and help information contained in Panorama Maker.

Image File Names and Folder Names

See “Image File Names and Folder Names” (🔗 44) and “Image/Sound File and Folder Names” (🔗 117) for more information.

Connecting to a Printer

Users of PictBridge-compatible (📷 133) printers can connect the camera directly to the printer and print pictures without using a computer.

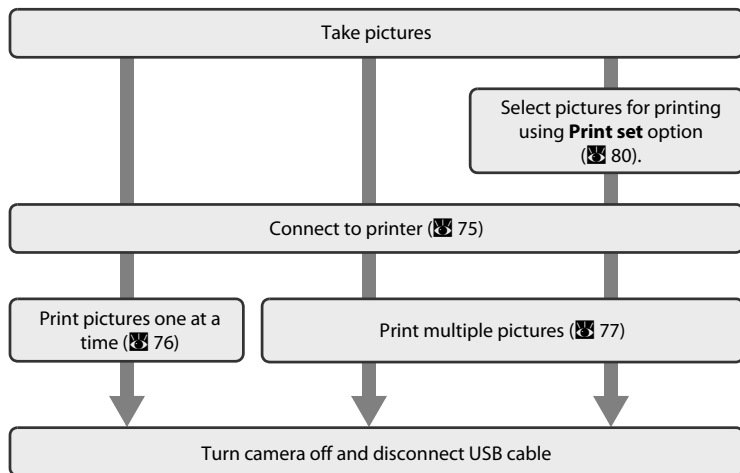

✔ **Note on Power Source**

When connecting the camera to a printer, use a fully charged battery to prevent the camera from turning off unexpectedly.

💡 **Printing Pictures**

In addition to printing pictures transferred to a computer from your personal printer and printing over a direct camera-to-printer connection, the following options are also available for printing pictures:

- Insert a memory card into a DPOF-compatible printer's card slot
- Take a memory card to a digital photo lab

For printing using these methods, specify the pictures and the number of prints each using your camera's print set menu (📷 80).

Connecting the Camera and Printer

- 1 Turn off the camera.

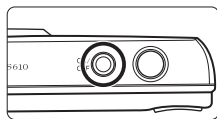

- 2 Turn on the printer.

Check printer settings.

- 3 Connect the camera to the printer using the supplied USB cable.

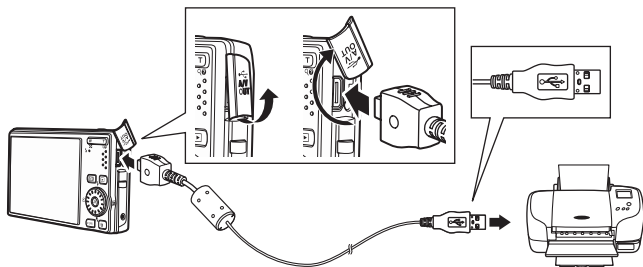

- 4 Turn on the camera.

When connected correctly, the PictBridge start-up screen

① will be displayed in the camera monitor. Then the print selection screen will be displayed ②.

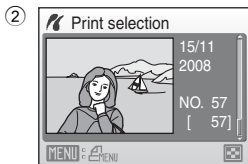
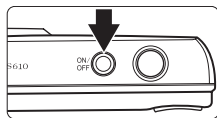

✓ Connecting the USB Cable

When connecting the USB cable, be sure that the connectors are oriented correctly. Do not use force when connecting the USB cable. When disconnecting the USB cable, do not pull the connector at an angle.

Printing Pictures One at a Time

After connecting the camera to the printer correctly (75), print pictures by following the procedure below.

- 1 Use the rotary multi selector to choose the desired picture and press the **OK** button.

Press the **W** button to display 12 thumbnails, and the **T** button to switch back to full-frame playback.

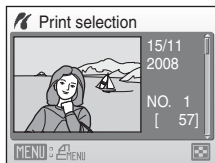

- 2 Choose **Copies** and press the **OK** button.

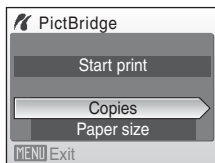

- 3 Choose the number of copies (up to nine) and press the **OK** button.

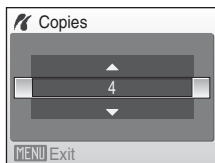

- 4 Choose **Paper size** and press the **OK** button.

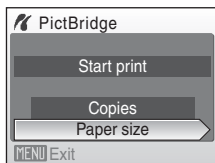

- 5 Choose the desired paper size and press the **OK** button.

To specify paper size using printer settings, choose **Default** in the paper size menu.

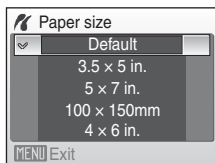

- 6** Choose **Start print** and press the **OK** button.

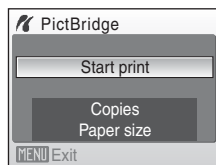

- 7** Printing starts.

Monitor display returns to that shown in step 1 when printing is complete.

To cancel before all copies have been printed, press the **OK** button.

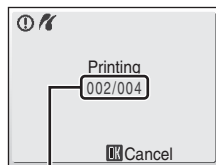

Current print/
total number of prints

Printing Multiple Pictures

After connecting the camera to the printer correctly (X 75), print pictures by following the procedure below.

- 1** When the print selection screen is displayed, press the **MENU** button.

The print menu is displayed.

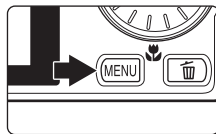

- 2** Use the rotary multi selector to choose **Paper size** and press the **OK** button.

To exit the print menu, press the **MENU** button.

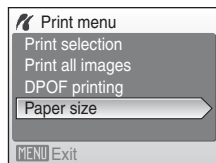

3 Choose the desired paper size and press the **OK** button.

To specify paper size using printer settings, choose **Default** in the paper size menu.

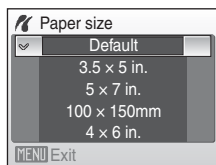

4 Choose **Print selection**, **Print all images** or **DPOF printing** and press the **OK** button.

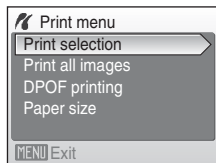

Print selection

Choose the pictures (up to 99) and number of copies (up to nine) of each. Rotate the rotary multi selector, or press **◀** or **▶**, to select pictures, and press **▲** or **▼** to set the number of copies for each.

Pictures selected for printing can be recognized by the check mark (✓) and the numeral indicating the number of copies to be printed. A check mark is not displayed with pictures for which no copies have been specified and these pictures will not be printed.

Press the **T** (Q) button to switch to full-frame playback.

Press the **W** (B) button to switch back to thumbnail display.

Press the **OK** button when setting is complete.

To print, choose **Start print** from the menu displayed and shown at right, and press the **OK** button.

Choose **Cancel** and press the **OK** button to return to the print menu.

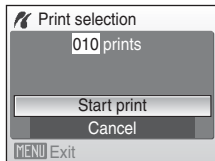
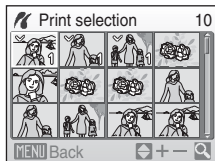

Print all images

All pictures stored in the internal memory, or on the memory card, are printed one at a time.

To print, choose **Start print** from the menu displayed and shown at right, and press the **OK** button.

Choose **Cancel** and press the **OK** button to return to the print menu.

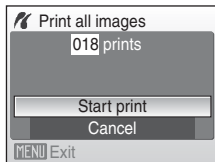
**DPOF printing**

Print pictures for which a print order was created in **Print set** (p. 80).

To print, choose **Start print** from the menu displayed and shown at right, and press the **OK** button.

Choose **Cancel** and press the **OK** button to return to the print menu.

To view the current print order, choose **View images** and press the **OK** button. To print pictures, press the **OK** button again.

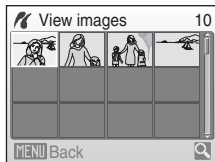
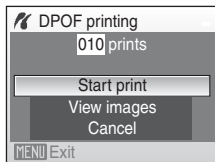
**5 Printing starts.**

Monitor display returns to the print menu (step 2) when printing is complete.

To cancel before all copies have been printed, press the **OK** button.

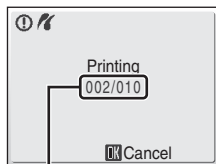

Current print/
total number of prints

Paper Size

The camera supports the following paper sizes: **Default** (the default paper size for the current printer), **3.5 x 5 in.**, **5 x 7 in.**, **100 x 150mm**, **4 x 6 in.**, **8 x 10 in.**, **Letter**, **A3**, and **A4**. Only sizes supported by the current printer will be displayed.

Creating a DPOF Print Order: Print Set

The **Print set** option in the playback menu is used to create digital “print orders” for printing on DPOF-compatible devices (❏ 133).

When the camera is connected to a PictBridge-compatible printer, pictures can be printed from the printer according to the DPOF print order you have created for pictures on the memory card. If the memory card is removed from the camera, you can create the DPOF print order for pictures in the internal memory and print pictures according to the DPOF print order.

1 Press the **MENU** button in playback mode.

The playback menu is displayed.

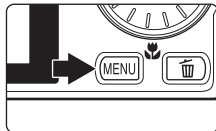

2 Use the rotary multi selector to choose **Print set** and press the **OK** button.

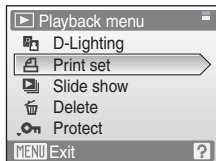

3 Choose **Select images** and press the **OK** button.

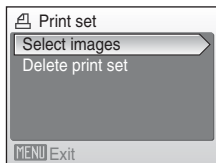

4 Choose the pictures (up to 99) and number of copies (up to nine) of each.

Rotate the rotary multi selector, or press ◀ or ▶, to select pictures, and press ▲ or ▼ to set the number of copies for each.

Pictures selected for printing can be recognized by the check mark (✔) icon and the numeral indicating the number of copies to be printed. A check mark is not displayed with pictures for which no copies have been specified and these pictures will not be printed.

Press the **T** (🔍) button to switch to full-frame playback.

Press the **W** (🖼️) button to switch back to thumbnail display.

Press the **OK** button when setting is complete.

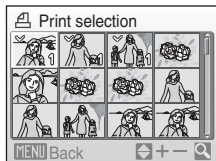



5 Choose whether or not to also print shooting date and photo information.

Choose **Date** and press the **OK** button to print date of recording on all pictures in the print order.

Choose **Info** and press the **OK** button to print photo information (shutter speed and aperture) on all pictures in the print order.

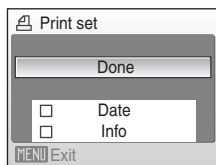
Choose **Done** and press the **OK** button to complete the print order and exit.



Pictures selected for printing are recognized by the  icon displayed with playback.



Notes on Printing Shooting Date and Photo Information

When the **Date** and **Info** options are enabled in the **Print set** menu, shooting date and photo information are printed on pictures when a DPOF-compatible ( 133) printer which supports printing of shooting date and photo information is used.

- Photo information cannot be printed when the camera is connected directly to a printer, via the supplied USB cable, for DPOF printing ( 79).
- **Date** and **Info** are reset each time the print set menu is displayed.

Deleting All Print Orders

Choose **Delete print set** in step 3 and press the **OK** button. Print orders for all pictures will be deleted.

Note on the Print Set Date Option

The date and time printed on pictures with DPOF printing when **Date** in the print set menu is enabled, are those recorded with the picture as it was taken. Date and time printed using this option are not affected when the camera's date and time setting are changed from the setup menu after pictures are recorded.



















Date Imprint

When date and time of recording are imprinted on pictures using the **Date Imprint** option ( 108) in the setup menu, pictures with the date and time imprinted on them can be printed from printers that do not support printing of the date and time on pictures. Only the **Date Imprint** date and time on pictures will be printed, even if **Print set** is enabled with **Date** selected in the print set screen.

Shooting Options: The Shooting Menu

The shooting menu of  (auto) mode contains the following options.

	Image mode*	 83
	Choose image size and quality.	
	White balance	 85
	Match white balance to the light source.	
	Metering	 87
	Choose how the camera meters exposure.	
	Continuous	 88
	Change settings for Continuous or BSS (best shot selector).	
	ISO sensitivity	 89
	Control camera's sensitivity to light.	
	Color options	 89
	Apply color effects to pictures as they are recorded.	
	AF area mode	 90
	Choose where the camera focuses.	
	Autofocus mode	 93
	Choose how the camera focuses.	

* The **Image mode** setting is also available from other shooting menus (except the movie menu).

Displaying the Shooting Menu

Enter  (auto) mode by pressing the **MODE** button in shooting mode and then selecting  (auto). Press the **MENU** button to display the shooting menu.

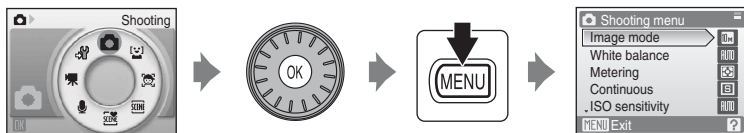









- Use the rotary multi selector to choose and apply settings ( 9).
- To return to the shooting mode from the shooting menu, press the **MENU** button.

Functions that Cannot Be Applied Simultaneously

Some functions cannot be enabled in conjunction with others ( 94).

Image Mode

Choose an image mode, which is the combination of image size and image quality (compression), according to how you plan to use the picture and the capacity of the internal memory or memory card. The larger the image, the larger the size at which it can be printed or displayed without becoming noticeably “grainy,” limiting the number of pictures that can be recorded.

Option	Size (pixels)	Description
 High (3648★)	3,648 × 2,736	Highest quality, suitable for enlargements or high-quality prints. The compression ratio is approximately 1:4.
 Normal (3648) (default setting)	3,648 × 2,736	Best choice in most situations. The compression ratio is approximately 1:8.
 Normal (3072)	3,072 × 2,304	
 Normal (2592)	2,592 × 1,944	
 Normal (2048)	2,048 × 1,536	Smaller size allows more pictures to be stored. The compression ratio is approximately 1:8.
 PC screen (1024)	1,024 × 768	Suited to display on computer monitor. The compression ratio is approximately 1:8.
 TV screen (640)	640 × 480	Suited to full-screen display on a television or distribution by e-mail or the web. The compression ratio is approximately 1:8.
 16:9 (3584)	3,584 × 2,016	Pictures with an aspect ratio of 16:9 can be taken. The compression ratio for both image sizes is approximately 1:8.
 16:9 (1920)	1,920 × 1,080	









The icon for the current setting is displayed in the monitor in shooting and playback modes ( 6, 7).

Image Mode

Changes made to the image mode setting apply to all shooting modes (except those available from the movie menu).

The Number of Exposures Remaining

The following table lists the approximate number of pictures that can be stored in internal memory and on a 256 MB memory card. Note that the number of pictures that can be stored will differ depending on the composition of the picture (due to JPEG compression). In addition, this number may differ depending on the make of memory card, even if the capacity for the memory card is the same.

Setting	Internal memory (approx. 45 MB)	Memory card ¹ (256 MB)	Print size ² (cm/in.)
 High (3648★)	9	50	31 × 23/12.2 × 9
 Normal (3648)	16	90	31 × 23/12.2 × 9
 Normal (3072)	22	120	26 × 19.5/10.2 × 7.6
 Normal (2592)	31	170	22 × 16.5/8.6 × 6.4
 Normal (2048)	49	270	17 × 13/6.7 × 5.1
 PC screen (1024)	159	850	9 × 7/3.5 × 2.7
 TV screen (640)	319	1700	5 × 4/1.9 × 1.5
 16:9 (3584)	22	120	30 × 17/11.8 × 6.6
 16:9 (1920)	73	400	16 × 9/6.3 × 3.5

¹ If the number of exposures remaining is 10,000 or more, the number of exposure remaining display shows **9999**.

² Print size at an output resolution of 300 dpi. Print sizes are calculated by dividing the number of pixels by printer resolution (dpi) and multiplying by 2.54 cm (1 in.). However, at the same image size, pictures printed at higher resolutions will print smaller than the size indicated, and those printed at lower resolutions will print larger than the size indicated.

WB White Balance

The color of light reflected from an object varies with the color of the light source. The human brain is able to adapt to changes in the color of the light source, with the result that white objects appear white whether seen in the shade, direct sunlight, or under incandescent lighting. Digital cameras can mimic this adjustment by processing images according to the color of the light source. This is known as “white balance.” For natural coloration, choose a white balance setting that matches the light source before shooting. Although the default setting, **Auto**, can be used under most types of lighting, you can apply the white balance setting suited to a particular light source to achieve more accurate results.

Auto (default setting)

White balance automatically adjusted to suit lighting conditions. Best choice in most situations.

Preset manual

Neutral-colored object used as reference to set white balance under unusual lighting conditions, see “Preset Manual” ( 86) for details.

Daylight

White balance adjusted for direct sunlight.

Incandescent

Use under incandescent lighting.

Fluorescent

Use under most types of fluorescent lighting.

Cloudy

Use when shooting under overcast skies.

Flash

Use with the flash.

The effects of the selected option can be previewed in the monitor. At settings other than **Auto**, the icon for the current setting is displayed in the monitor ( 6).

Flash Mode

At white-balance settings other than **Auto** or **Flash**, turn the flash off (  30).

Preset Manual

Preset manual is used with mixed lighting or to compensate for light sources with a strong color cast (for example, to make pictures taken under a lamp with a red shade look as though they had been taken under white light).

1 Place a white or gray reference object under the lighting that will be used during shooting.

2 Use the rotary multi selector to choose **PRE Preset manual** in the white balance menu, and press the **OK** button.

The camera zooms in.

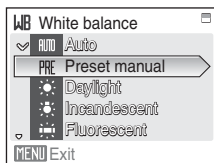

3 Choose **Measure**.

To apply the most recently measured value for preset manual, choose **Cancel** and press the **OK** button.

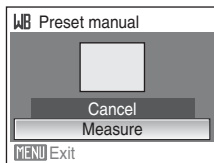

4 Frame the reference object.

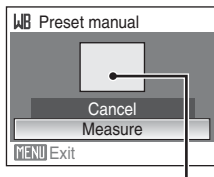

Reference object frame

5 Press the **OK** button to measure the white balance value.

The shutter is released and the new white-balance value is set.

No pictures are recorded.

Note on Preset Manual

Regardless of the flash mode selected, the flash will not fire when the **OK** button is pressed in step 5. Therefore, the camera cannot measure a value for preset manual for when the flash is used.

Metering

Choose how the camera meters exposure.



Matrix (default setting)

Camera sets exposure for entire frame. Recommended in most situations.



Center-weighted

Camera meters entire frame but assigns greatest weight to subject in center of frame. Classic meter for portraits; preserves background details while letting lighting conditions at center of frame determine exposure. Can be used with focus lock ( 91) to meter off-center subjects.

Note on Metering

When digital zoom is in effect, **Metering** is set to **Center-weighted**, and the metered area is not displayed in the monitor.

Metering Area

The active metering area is displayed in the monitor when **Center-weighted** is selected.

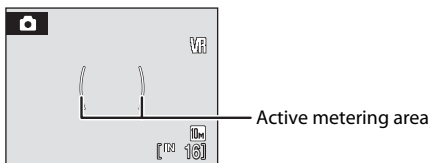

Continuous

Change settings to Continuous or Best Shot Selector (BSS). Flash will be switched off when **Continuous** or **BSS** is selected. Focus, exposure, and white balance are fixed at the values for the first picture in each series.

Single (default setting)

One picture is taken each time shutter-release button is pressed.

Continuous

While the shutter-release button is held down, pictures are taken at rate of up to about 1.0 frames per second (fps) when image mode is set to  **Normal (3648)**. Shooting ends when the shutter-release button is released, or ten shots have been taken with the shutter-release button held down.

BSS

BSS is recommended for shooting under low lighting without the flash, with the camera zoomed in, or in other situations in which camera shake is likely to blur pictures. The camera takes up to ten pictures while the shutter-release button is held down. The sharpest picture (picture with the most detail) in the series is automatically selected and saved.

At settings other than **Single**, the indicator for the current setting is displayed in the monitor ( 6).

Note on Continuous Shooting

The maximum frame rate with continuous shooting may vary, depending upon the current image mode setting and the memory card used.

Note on Best Shot Selector

BSS may not produce the desired results if the subject moves or the composition changes while the shutter-release button is pressed all the way down.

ISO ISO Sensitivity

Sensitivity is a measure of how quickly the camera reacts to light. The higher the sensitivity, the less light needed to make an exposure. Although a high ISO rating is suited for taking pictures of subjects in action or in poor lighting, high sensitivity is often associated with “noise” -randomly spaced, brightly colored pixels concentrated in dark parts of the image.

Auto (default setting)

Sensitivity is ISO 100 under normal conditions; when lighting is poor, the camera compensates by raising sensitivity to a maximum of ISO 1600.

100, 200, 400, 800, 1600, 3200

Sensitivity will be locked at the specified value.
When ISO sensitivity is locked, **Motion detection** (📷 110) does not function even when **Auto** is selected for **Motion detection**.

At settings other than **Auto**, the current setting is displayed in the monitor (📷 6). If **Auto** is selected and the sensitivity is raised above an ISO 100, the **ISO** icon will be displayed (📷 31).

🎨 Color Options

Make colors more vivid or record pictures in monochrome.

📷 Standard color (default setting)

Use for pictures exhibiting natural color.

🎨 Vivid color

Use to achieve a vivid, “photoprint” effect.

📷 Black-and-white

Record pictures in black-and-white.

📷 Sepia

Record pictures in sepia tones.

📷 Cyanotype

Record pictures in cyan-blue monochrome.

📷 Pastel

Change to a pastel shade.

At settings other than **Standard color**, the icon for the current setting is displayed in the monitor (📷 6). Monitor color tones also change depending upon the setting.

[+] **AF Area Mode**

Use this option to determine where the camera focuses.

When digital zoom is in effect, the camera will focus on the subject in the center focus area regardless of the applied **AF area mode** option.



Face priority

The camera automatically detects and focuses on a face looking toward the camera (Shooting with Face Priority → 92). If the camera detects multiple faces, the camera focuses on the face closest to the camera.

When shooting pictures of subjects other than people, or framing a subject with which no face is recognized, **AF area mode** will be set to **Auto**. The camera chooses the focus area (one of nine) containing the subject closest to the camera and focuses on the subject.



Auto (default setting)

Camera automatically selects the focus area (one of nine) containing the subject closest to the camera. Press the shutter-release button halfway to activate the focus area. When the shutter-release button is pressed halfway, the focus area selected by the camera will be displayed in the monitor.

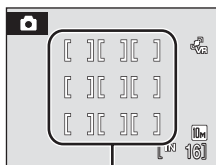

Focus areas



Manual

This option is suited to situations in which the intended subject is relatively still and not positioned in the center of the frame.

Press the rotary multi selector ▲, ▼, ◀ or ▶ to select one of 99 focus areas displayed in the monitor's focus-area selection screen, and shoot. To end focus-area selection and adjust the flash mode, macro mode, self-timer and exposure compensation settings, press the **OK** button. To return to the focus-area selection screen, press the **OK** button.

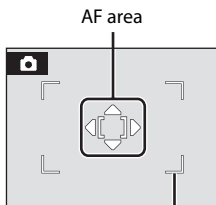

Selectable focus areas

Center

Camera focuses on subject in center of frame.
Center focus area is always used.

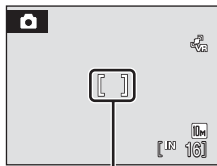

AF area

Focus Lock

To focus on off-center subjects when **Center** is selected for **AF area mode**, use focus lock as described below.

- 1 Position the subject in the center of the frame.
- 2 Press the shutter-release button halfway.
 - Confirm that the focus area indicator is green.
 - Focus and exposure are locked.
- 3 Continue holding down the shutter-release button halfway and recompose the picture.
 - Be sure that the distance between the camera and the subject does not change.
- 4 Press the shutter-release button the rest of the way down to shoot.



More Information

See "Autofocus" ( 27) for more information.

Shooting with Face Priority

The face-priority function is activated when **Face priority** is selected for **AF area mode** (📷 90), when shooting in **Portrait** (📷 36) or **Night portrait** (📷 37) scene mode, when shooting in scene auto selector mode (📷 45), or when shooting in smile mode (📷 49).

The camera automatically detects and focuses on a face looking toward the camera.

1 Frame a picture.

When the camera detects a face looking toward the camera, that face will be framed by a yellow double border.



When the camera detects more than one face, operation varies, depending upon the shooting mode, as follows.

Shooting mode	Faces framed by a double border	The number of faces to be recognized
📷 (auto) mode (Face priority)	The face closest to the camera * The other faces are framed by a single border.	Up to 12
Scene mode: Portrait, Night portrait		
Smile mode	The face closest to the center of the frame * The other faces are framed by a single border.	Up to 3

2 Press the shutter-release button halfway.

The camera focuses on the face framed by the double border. The double border will glow green and focus will be locked.

When the camera is unable to focus, the double border will blink. Press the shutter-release button halfway again and focus.

Press the shutter-release button the rest of the way down to take the picture.

You don't need to press the shutter-release button halfway in smile mode. If the camera detects the smiling face, the shutter is automatically released (📷 49).

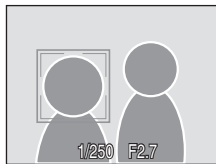

✓ Notes on Face Priority

- When **Face priority** is selected for **AF area mode**, the setting will automatically switch to **Auto** if no face is detected when the shutter-release button is pressed halfway.
- If no face is detected when the shutter-release button is pressed halfway in **Portrait** or **Night portrait** scene mode, or smile mode, the camera will focus on the subject in the center focus area.
- The camera may be unable to detect faces in the following situations:
 - When faces are partially hidden by sunglasses or other obstructions
 - When faces take up too much or too little of the frame
 - When the subject is not looking directly at the camera
- The camera's ability to detect faces depends on a variety of factors, including whether or not the subject is facing the camera.
- In some rare cases shooting subjects with which autofocus may not perform as expected (📷 27), the subject may not be in focus despite the fact that the double border glows green. Should this occur, switch to 📷 (auto) mode and set **AF area mode** to **Manual** or **Center**, refocus on another subject positioned at the same distance from the camera as the actual portrait subject, and use focus lock (📷 91).
- When pictures in which a face was detected during shooting are played back, the pictures will be automatically rotated for playback display, according to the orientation of the face detected.

▶▶ Autofocus Mode

Choose how the camera focuses.



Single AF (default setting)

Camera focuses when the shutter-release button is pressed halfway.



Full-time AF

Camera adjusts focus continuously until the shutter-release button is pressed halfway. Use with moving subjects.

✓ Notes on Autofocus Mode

Autofocus mode will be automatically fixed at **Single AF** when **Face priority** is selected for **AF area mode** (📷 90).

Functions that Cannot Be Applied Simultaneously

Restrictions apply to the following settings in  (auto) mode.

Flash mode

Flash mode is automatically set to  (Off) and cannot be adjusted when **Continuous** or **BSS** is selected for the **Continuous** setting. Selecting **Single** for **Continuous** restores the last flash mode setting applied.

Self-timer

If self-timer is on, only one picture will be taken when the shutter is released, regardless of settings selected for the **Continuous** setting. The last **Continuous** setting applied is restored when picture is taken or self-timer is turned off.

White balance and Color options

















White balance is automatically set to **Auto** and cannot be adjusted when **Black-and-white**, **Sepia**, or **Cyanotype** is selected for **Color options**. Selecting **Standard color**, **Vivid color**, or **Pastel** restores the last **White balance** setting applied.

Autofocus mode

Autofocus mode is automatically set to **Single AF** and cannot be adjusted when **Face priority** is selected for **AF area mode**. The last autofocus mode setting applied is restored when any setting other than **Face priority** is selected for **AF area mode**.

Playback Options: The Playback Menu

The playback menu contains the following options.

 D-Lighting  54
Enhances brightness and contrast in dark portions of pictures.
 Print set  80
Select pictures to print and the number of copies for each.
 Slide show  97
View pictures stored in the internal memory or on a memory card in an automatic slide show.
 Delete  98
Delete all or selected pictures.
 Protect  98
Protect selected pictures from accidental deletion.
 Rotate image  99
Change the orientation of an existing picture.
 Small pic.  56
Create a small copy of the current picture.
 Copy  100
Copy files between memory card and internal memory.

Displaying the Playback Menu

Enter the playback mode by pressing the  button.

Display the playback menu by pressing the **MENU** button.

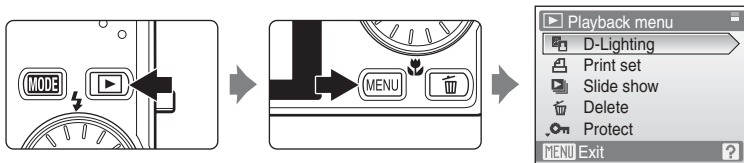

- Use the rotary multi selector to choose and apply settings.  9)
- To exit the playback menu, press the **MENU** button.

Selecting Pictures

The picture selection screen, as shown at right, will be displayed with the following menus:

- **Playback menu:** **Print set**>**Select images** (🗑️ 80)
Delete>**Erase selected images** (🗑️ 98)
Protect (🔒 98)
Rotate image (🔄 99)
Copy>**Selected images** (🗑️ 100)
- **Setup menu:** **Welcome screen** (🗑️ 103)



Follow the procedure described below to select pictures.

- 1** Rotate the rotary multi selector, or press ◀ or ▶, to choose the desired picture.

Only one picture can be selected for **Rotate image** and **Welcome screen**. Proceed to step 3.

Press the **T** (🔍) button to switch to full-frame playback.

Press the **W** (🗑️) button to switch back to thumbnail display.

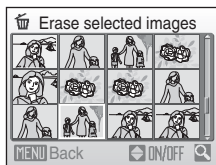

- 2** Press ▲ or ▼ to select **ON** or **OFF** (or the number of copies).

When **ON** is selected, a check mark (☑️) is displayed in the current picture. Repeat steps 1 and 2 to select additional pictures.



- 3** Press the (OK) button to apply picture selection.

Slide Show

Play back pictures, stored in the internal memory or on a memory card, one by one in an automated “slide show”.

1 Use the rotary multi selector to choose **Start** and press the **OK** button.

To change the interval between pictures, choose **Frame intvl**, select the desired interval time, and press the **OK** button before choosing **Start**.

To repeat the slide show automatically, enable **Loop** and press the **OK** button before choosing **Start**. The check mark (✓) will be added to the loop option when enabled.

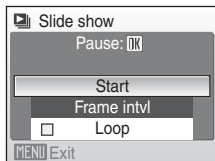

2 The slide show begins.

While the slide show is in progress, the following operations can be performed:

- Press the rotary multi selector **▶** to view pictures in the order recorded, or **◀** to view pictures in reverse order. Press and hold **▶** to fast forward, or **◀** to rewind.
- Press the **OK** button to pause the slide show.



3 Choose **End** or **Restart**.

When the slide show ends or is paused, choose **End** and press the **OK** button to return to the playback menu, or choose **Restart** to play the slide show again.

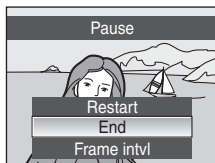

Notes on Slide Show

- Movies are not included in slide shows.
- Slide shows play for a maximum of 30 minutes, even when **Loop** is selected (112).

Delete

Delete selected pictures or all pictures.

Erase selected images

Delete selected pictures ( 96).

Erase all images

Delete all pictures.

Notes on Deletion

- Once deleted, pictures cannot be recovered. Transfer important images to a computer before deletion.
- Pictures marked with the  icon are protected and cannot be deleted.

Deleting Picture Bank Images (For Users of the COOLPIX S610c)

Select the **Picture Bank images** option (51 of the *Wireless LAN Connection Guide*) from the **Delete** item in list by date menu to delete only those pictures, taken on the specified date, that have already been uploaded to the my Picturetown server.

Protect

Protect selected pictures from accidental deletion (Selecting Pictures →  96).



Note, however, that formatting the camera's internal memory or the memory card will permanently erase protected files ( 112).

Protected pictures are recognized by the  icon ( 7, 51) in playback mode.

Rotate Image

Change the orientation of pictures played back in the camera's monitor after shooting.

Pictures can be rotated 90° clockwise or counterclockwise. Pictures that were recorded in the portrait (vertical) orientation can be rotated up to 180° in either direction.

Select a picture in the picture selection screen ( 96), and press the  button to display the **Rotate image** screen.

Press the rotary multi selector  or  to rotate the picture 90°.

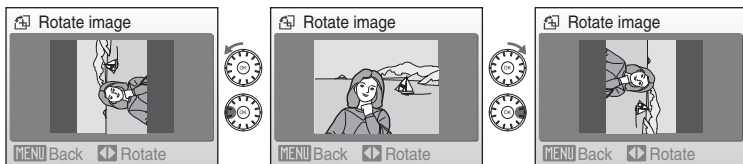

Rotate 90° counterclockwise

Rotate 90° clockwise

Press the  button to set the orientation displayed, and save the orientation data with the picture.

Copy

Copy pictures between the internal memory and a memory card.

- Use the rotary multi selector to select an option from the copy screen and press the **OK** button.

IN → C: Copy pictures from internal memory to memory card.

C → IN: Copy pictures from memory card to internal memory.

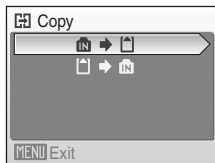

- Select a copy option and press the **OK** button.

Selected images: Copy pictures selected from the picture selection screen (p. 96).

All images: Copy all pictures.

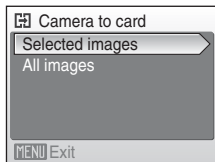

Notes on Copying Pictures

- JPEG-, AVI-, and WAV-format files can be copied. Files recorded in any other format cannot be copied.
- If voice memos (p. 57) are attached to pictures selected for copying, voice memos are copied with the pictures.
- Sound files recorded in voice recording mode (p. 64) can be copied using the **Copy sound files** option (p. 68) in sound file playback mode.
- Pictures recorded with another make or model of camera or that have been modified on a computer cannot be copied.
- Edited copies have the same protection marking (p. 98) as the original, but are not marked for printing (p. 80).

Memory contains no images. Message

































If there are no pictures stored on the memory card when playback mode is applied, the message, **Memory contains no images.**, will be displayed. Press the **MENU** button to display the copy option screen, and copy the pictures stored in the camera's internal memory to the memory card.

More Information

See "Image/Sound File and Folder Names" (p. 117) for more information.

Basic Camera Setup: The Setup Menu

The setup menu contains the following options.

	Menus  102
	Choose how menus are displayed.
	Welcome screen  103
	Select screen displayed when camera is turned on.
	Date  104
	Set camera clock and choose home and destination time zones.
	Monitor settings  107
	Adjust monitor brightness and choose display style.
	Date imprint  108
	Imprint date or date counter on pictures.
	Vibration reduction  109
	Choose whether or not vibration reduction is enabled.
	Motion detection  110
	Adjust the motion detection setting to reduce the effects of camera shake and subject movement when shooting still pictures.
	AF assist  110
	Enable or disable AF assist illumination.
	Digital zoom  111
	Enable or disable digital zoom.
	Sound settings  111
	Adjust sound settings.
	Auto off  112
	Set time before camera enters standby mode.
	Format memory/Format card  112
	Format internal memory or memory card.
	Language  113
	Choose language used for camera monitor display.
	Video mode  113
	Adjust settings necessary for connection to TV.
	Reset all  113
	Restore camera settings to default values.
	Wireless settings (COOLPIX S610c only)
	Adjust settings for wireless LAN features. See the <i>Wireless LAN Connection Guide</i> for more information.
	Firmware version  115
	Display camera firmware version.

Displaying the Setup Menu

First, display the shooting-mode or playback-mode selection menu by pressing the **MODE** button. Then select  (use the rotary multi selector), press the **OK** button.



- Use the rotary multi selector to choose and apply settings.  9)
- To exit the setup menu, press the **MODE** button and choose any mode other than setup mode.

MENU Menu

Select a format for menu display.

Text (default setting)

Menus are displayed in list format.

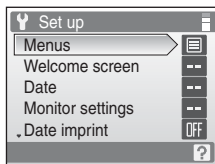

Icons

All menu items can be displayed in a single page.

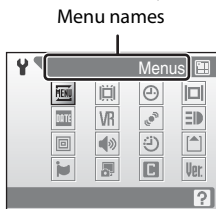

COOLPIX S610

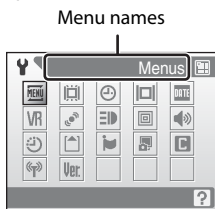

COOLPIX S610c

Welcome Screen

You can select the welcome screen to be displayed when the camera is turned on.

None (default setting)

Welcome screen is not displayed.

COOLPIX

Displays a welcome screen.

Select an image

Select a picture in the internal memory or on the memory card for the welcome screen. Choose a picture in the picture selection screen (📷 96), and press the **OK** button.

As the selected image is stored in the camera, the image will appear in the welcome screen even if the original picture is deleted.

Pictures taken at an image mode setting (📷 83) of **16:9 (3584)** or **16:9 (1920)**, and copies created at a size of 320 × 240 or smaller using the crop (📷 55) or small picture (📷 56) function, cannot be used.

Date

Set the camera clock and choose home and travel destination time zones.



Date

Set camera clock to current date and time.

Use the following controls to set the date and time.

- ◀ and ▶: highlight a different item (day, month, year, and the order in which day, month, and year are displayed)
- ▲ and ▼: edit the highlighted item
- The  button: apply the setting

Time zone

 (home time zone) can be specified and daylight saving enabled or disabled from **Time zone** options. When  (travel destination) is selected, the time difference ( 106) is automatically calculated and the date and time in the selected region are recorded. Useful when travelling.

Setting Travel Destination Time Zone

- 1 Use the rotary multi selector to choose **Time zone** and press the  button.

The time zone menu is displayed.

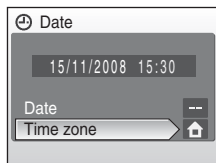

- 2 Choose  **Travel destination** and press the  button.

The date and time displayed on the monitor changes according to the region currently selected.

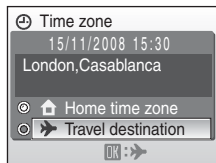

- 3 Press .

The time zone selection screen is displayed.



4 Press ◀ or ▶ to choose the travel destination time zone.

If the daylight saving time is in effect, press ▲ to turn on the daylight saving time option. When the option is enabled, ☀ is displayed at the top of the monitor, and the time is advanced one hour.

To turn off the daylight saving time option, press ▼.

Press the OK button to choose the travel destination time zone.

While the travel destination time zone is selected, the ⌂ icon will be displayed in the monitor when the camera is in shooting mode.

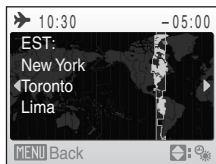

✓ The Clock Battery

The clock battery charges when the main battery is installed or an AC adapter is connected, and can provide several days of backup power after about 10 hours of charging.

✎ 🏠 (Home Time Zone)

- To switch to the home time zone, choose 🏠 **Home time zone** in step 2 and press the OK button.
- To change the home time zone, choose 🏠 **Home time zone** in step 2 and perform step 3 and 4, to set the home time zone.

✎ 🕒 Daylight Saving Time

When daylight saving time starts or ends, turn the daylight saving time option on or off from the time zone selection screen displayed in step 4.

 **Time Zones (18)**

The camera supports the time zones listed below. For time differences not listed below, set the camera clock to local time.

UTC +/-	Location	UTC +/-	Location
-11	Midway, Samoa	+1	Madrid, Paris, Berlin
-10	Hawaii, Tahiti	+2	Athens, Helsinki, Ankara
-9	Alaska, Anchorage	+3	Moscow, Nairobi, Riyadh, Kuwait, Manama
-8	PST (PDT): Los Angeles, Seattle, Vancouver	+4	Abu Dhabi, Dubai
-7	MST (MDT): Denver, Phoenix, La Paz	+5	Islamabad, Karachi
-6	CST (CDT): Chicago, Houston, Mexico City	+5.5	New Delhi
-5	EST (EDT): New York, Toronto, Lima	+6	Colombo, Dhaka
-4	Caracas, Manaus	+7	Bangkok, Jakarta
-3	Buenos Aires, Sao Paulo	+8	Beijing, Hong Kong, Singapore
-2	Fernando de Noronha	+9	Tokyo, Seoul
-1	Azores	+10	Sydney, Guam
±0	London, Casablanca	+11	New Caledonia
		+12	Auckland, Fiji

Monitor Settings

Choose whether or not to display information in the monitor, and set the monitor brightness.

Photo info

Choose information displayed in the monitor during shooting and playback mode.

Brightness



Choose from five settings for monitor brightness. The default setting is **3**.

When monitor brightness boost (🔆 23) is activated, the monitor brightness is set to **5** and cannot be changed.

Photo Info

The following display options are available.

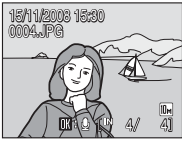
See “The Monitor” (🔍 6) for information on indicators in the monitor.

	Shooting mode	Playback mode
Show info		
Auto info (default setting)	The current settings or operation guide is displayed as in Show info above. After a few seconds, display will be the same as Hide info .	
Hide info		

Date Imprint

Date and time of recording can be imprinted on pictures. This information can be printed even from printers that do not support printing of date and time ( 81).

Off (default setting)

Date and time are not imprinted on pictures.

Date



Date is imprinted on the bottom right corner of pictures taken while this option is in effect.

Date and time

Date and time are imprinted on the bottom right corner of pictures taken while this option is in effect.

At settings other than **Off**, the icon for the current setting is displayed in the monitor during shooting ( 6).

Date Imprint

- Imprinted dates form a permanent part of image data and cannot be deleted.
- Dates imprinted at an image mode setting ( 83) of **TV TV screen (640)** may be difficult to read. Choose **PC PC screen (1024)** or larger when using date imprint.
- The date is recorded using the format selected in the setup menu's **Date** item ( 18, 104).
- The date cannot be imprinted on movies or on pictures taken in **Panorama assist** scene mode ( 41).

Date Imprint and Print Set

When printing from DPOF-compatible printers which support printing of shooting date and photo information, the date and information can be printed on pictures without date and time imprinted on them, using options in the **Print set** menu ( 80).

Vibration Reduction

Vibration reduction effectively corrects blur, caused by slight hand movement known as camera shake, that commonly occurs when shooting with zoom applied or at slow shutter speeds. Vibration reduction can be used in all shooting modes.

Set **Vibration reduction** to **Off** when using a tripod to stabilize the camera during shooting.

When vibration reduction is enabled, the current setting is displayed during shooting (when **Off** is selected, an icon for the current setting is not displayed)

( 6, 23).

On (default setting)

Vibration reduction is enabled when taking pictures and recording movies. Camera detects and factors out panning movements when reducing camera shake. When camera is panned horizontally, for example, vibration reduction reduces only vertical shake. If camera is panned vertically, vibration reduction affects only horizontal shake.

Off

Vibration reduction is not enabled.

Notes on Vibration Reduction

- Vibration reduction may take a few seconds to activate after the power is turned on, or the camera enters shooting mode from playback mode. Wait until the display stabilizes before shooting.
- Due to characteristics of the vibration reduction function, images displayed in the camera's monitor immediately after shooting may appear blurry.
- Vibration reduction may be unable to completely eliminate the effects of camera shake in some situations.
- **VR** stands for vibration reduction.

Motion Detection





Enable motion detection to reduce the effects of camera shake and subject movement when shooting still pictures.

When motion detection is enabled, the current setting is displayed in the monitor during shooting ( 6, 23).

Auto (default setting)

When camera detects the movement of the subject or camera shake, the shutter speed will be increased for reducing the effects of them.

However, motion detection does not function in the following situations.

- When the flash fires
- When any setting other than **Auto** is selected for **ISO sensitivity** ( 89) in  (auto) mode
- When shooting in **Night portrait** () 37), **Fireworks show** () 40), or **Backlight** () 40) scene mode

Off

Motion detection is not enabled.

Notes on Motion Detection

- Motion detection may be unable to completely reduce the camera shake and subject movement in some situations.
- Motion detection may not function if the subject exhibits significant movement or is too dark.
- The pictures taken may become somewhat grainy.

AF Assist

Enable or disable AF-assist illumination.

Auto (default setting)

AF-assist illumination will be used to assist the focus operation when the subject is poorly lit. The illuminator has a range of about 3.0 m (9 ft. 10 in.) at the maximum wide-angle position and about 1.5 m (4 ft. 11 in.) at the maximum telephoto position. Note that for some scene modes, AF-assist illumination turns off automatically () 36).

Off

Disable this function. The camera may be unable to focus if lighting is poor.

Digital Zoom

Enable or disable digital zoom.

On (default setting)

When the camera is zoomed in to the maximum optical zoom position, holding down the **T** (Q) button triggers digital zoom (25).

Off

Digital zoom will not be activated (except when shooting a movie).

Notes on Digital Zoom

- When digital zoom is in effect, **AF area mode** is set to **Center** (90).
- Digital zoom cannot be used in the following situations.
 - When **Portrait** or **Night portrait** is selected in scene mode
 - When scene auto selector mode is selected
 - When active child mode is selected
 - When smile mode is selected
 - Before movie recording begins (however, digital zoom of up to 2x can be applied while movies are being recorded).
- When digital zoom is in effect, **Metering** is set to **Center-weighted**.

Sound Settings

Adjust the following sound settings.

Button sound

Turn button sound **On** (default setting) or **Off**. When **On** (default setting) is selected, beep will sound once when operations are completed successfully, twice when the camera acquires focus on the subject, and three times when error is detected. Start-up sound will also play when the camera is turned on.

Shutter sound

Choose shutter sound from **On** (default setting) or **Off**.

Auto Off

If no operations are performed for the selected length of time, the monitor will turn off and the camera enters standby mode ( 15) to reduce drain on the batteries. The power-on lamp blinks in standby mode. If no operations are performed for another three minutes, the camera will turn off automatically.

Choose the time allowed to elapse before the camera enters standby mode if no operations are performed from **30 s**, **1 min** (default setting), **5 min**, and **30 min**.

Canceling Standby Mode

Cancel standby mode and reactivate the monitor by pressing the power switch or the shutter-release button.

Notes on Auto Off

Regardless of the option selected, the monitor will remain on as follows.

- When **30 s** or **1 min** is selected for **Auto off** and menus are displayed: three minutes
- During slide show playback: up to 30 minutes
- When the AC adapter is connected: 30 minutes

Format Memory/ **Format Card**

Use this option to format the internal memory or a memory card.

Formatting the Internal Memory

To format the internal memory, remove the memory card from the camera.

The **Format memory** option appears in the setup menu.

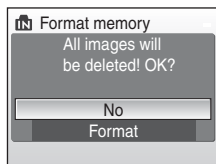

Formatting a Memory Card

When the memory card is inserted in the camera, the **Format card** option appears in the setup menu.

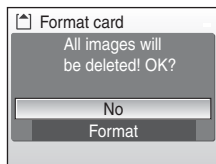

Formatting Internal Memory and Memory Cards

- Formatting the internal memory or memory cards permanently deletes all data. Be sure to transfer important pictures to a computer before formatting.
- Do not turn the camera off, disconnect the AC adapter, or open the battery-chamber/memory card slot cover during formatting.
- The first time you insert the memory cards used in other devices into this camera, be sure to format them with this camera.

Language

Choose one of 24 languages for display of camera menus and messages.

Čeština	Czech
Dansk	Danish
Deutsch	German
English	(default setting)
Español	Spanish
Ελληνικά	Greek
Français	French
Indonesia	Indonesian
Italiano	Italian
Magyar	Hungarian
Nederlands	Dutch
Norsk	Norwegian

Polski	Polish
Português	Portuguese
Русский	Russian
Suomi	Finnish
Svenska	Swedish
Türkçe	Turkish
عربي	Arabic
中文简体	Simplified Chinese
中文繁體	Traditional Chinese
日本語	Japanese
한글	Korean
ภาษาไทย	Thai

Video Mode





Adjust settings for connection to TV.

Choose from **NTSC** and **PAL**.

Reset All

When **Reset** is selected, the camera's settings will be restored to their default values.

Pop-up menu

Option	Default value
Flash mode ( 30)	Auto
Self-timer ( 32)	Off
Macro mode ( 33)	Off
Exposure compensation ( 34)	0.0

Scene mode

Option	Default value
Scene mode (📷 35)	Portrait
White balance in Food mode (📷 41)	Center

Movie menu

Option	Default value
Movie options (📷 62)	TV movie 640
Autofocus mode (📷 62)	Single AF

Shooting menu

Option	Default value
Image mode (📷 83)	📷 Normal (3648)
White balance (📷 85)	Auto
Metering (📷 87)	Matrix
Continuous (📷 88)	Single
ISO sensitivity (📷 89)	Auto
Color options (📷 89)	Standard color
AF area mode (📷 90)	Auto
Autofocus mode (📷 93)	Single AF

Setup menu

Option	Default value
Menus (📷 102)	Text
Welcome screen (📷 103)	None
Photo info (📷 107)	Auto info
Brightness (📷 107)	3
Date imprint (📷 108)	Off
Vibration reduction (📷 109)	On
Motion detection (📷 110)	Auto
AF assist (📷 110)	Auto
Digital zoom (📷 111)	On
Button sound (📷 111)	On
Shutter sound (📷 111)	On
Auto off (📷 112)	1 min

Others

Option	Default value
Paper size (🔍 76, 77)	Default
Slide show (🔍 97)	3 s
Monitor brightness boost (🔍 23)	Off

- Choosing **Reset all** also clears the current file number (🔍 117) from the memory. Numbering will continue from the lowest number available. To reset file numbering to “0001”, delete all pictures (🔍 98) before selecting **Reset all**.
- The following menu settings will remain unaffected when menus are reset with **Reset all**.

Shooting menu: Preset manual data (🔍 86) acquired for **White balance**

Setup menu: **Date** (🔍 104), **Language** (🔍 113), and **Video mode** (🔍 113)

Ver. Firmware Version

View the current camera firmware version.

See the *Wireless LAN Connection Guide* for more information on the camera’s MAC address displayed with the COOLPIX S610c.



Firmware version



MAC address
Firmware version

Optional Accessories

Rechargeable battery	Rechargeable Li-ion Battery EN-EL12
Battery charger	Battery Charger MH-65
AC adapter	AC Adapter EH-63
USB cable	USB Cable UC-E13
A/V Cable	Audio/Video Cable EG-CP15

Approved Memory Cards

The following Secure Digital (SD) memory cards have been tested and approved for use in this camera. All cards of the designated make and capacity can be used, regardless of speed.

SanDisk	128 MB, 256 MB, 512 MB, 1 GB, 2 GB ¹ , 4 GB ² , 8 GB ²
TOSHIBA	128 MB, 256 MB, 512 MB, 1 GB, 2 GB ¹ , 4 GB ² , 8 GB ²
Panasonic	128 MB, 256 MB, 512 MB, 1 GB, 2 GB ¹ , 4 GB ² , 8 GB ²

¹ If the memory card will be used with a card reader or similar device, check that device supports 2 GB cards.



²  SDHC-compliant. If the memory card will be used with a card reader or similar device, check that device supports SDHC.

Operation is not guaranteed with other makes of card. Contact the manufacturer for details on the above cards.

Image/Sound File and Folder Names

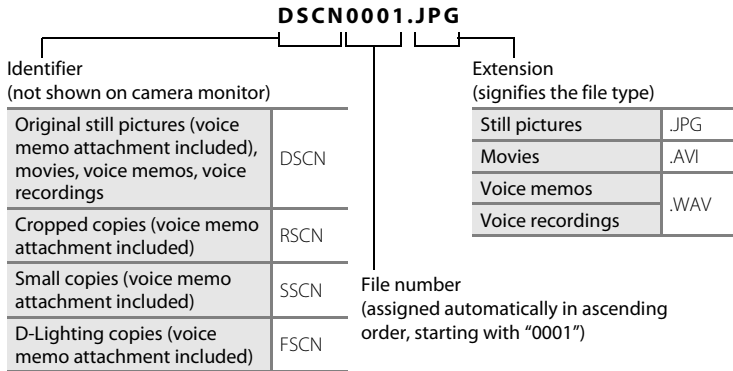
Pictures, movies, voice memos, and voice recordings are assigned file names as follows.



- Files are stored in folders named with a folder number followed by a five-character identifier: "SOUND" (normal quality sound) for voice recordings (e.g., "101SOUND";  64), and "NIKON" for all other pictures (e.g., "100NIKON"). When the number of files within a folder reaches 9999, a new folder will be created. File numbers will be assigned automatically starting with "0001".
- Voice memo file names have the same identifier and file number as the picture to which the voice memo is attached.
- Files copied using **Copy>Selected images** or **Copy sound files>Selected files** are copied to the current folder, where they are assigned new file numbers in ascending order starting from the largest file number in memory. **Copy>All images** and **Copy sound files>Copy all files** copy all folders from the source medium; file names do not change but new folder numbers are assigned in ascending order starting from the largest folder number on the destination medium ( 68, 100).
- A single folder can hold up to 200 pictures; if the current folder already contains 200 pictures, a new folder, named by adding one to the current folder name, will be created the next time a picture is taken. If the current folder is numbered 999 and contains 200 pictures, or a picture is numbered 9999, no further pictures can be taken until the internal memory or memory card is formatted ( 112), or a new memory card is inserted.

Caring for the Camera

To ensure continued enjoyment of this Nikon product, observe the following precautions when using or storing the device.

Keep Dry

The device will be damaged if immersed in water or subjected to high humidity.

Do Not Drop

The product may malfunction if subjected to strong shock or vibration.

Handle the Lens and all Moving Parts with Care

Do not apply force to the lens, lens cover, monitor, memory card slot or battery chamber. These parts are easily damaged. Applying force to the lens cover could result in camera malfunction or damage to the lens. Should the monitor break, care should be taken to avoid injury caused by broken glass and to prevent the liquid crystal from the display touching the skin or entering the eyes or mouth.

Do Not Point the Lens at Strong Light Sources for Extended Periods

Avoid pointing the lens at the sun or other strong light sources for extended periods when using or storing the camera. Intense light may cause deterioration of the image sensor, producing a white blur effect in photographs.

Keep Away from Strong Magnetic Fields

Do not use or store this device in the vicinity of equipment that generates strong electromagnetic radiation or magnetic fields. Strong static charges or the magnetic fields produced by equipment such as radio transmitters could interfere with the monitor, damage data stored on the memory card, or affect the product's internal circuitry.

Avoid Sudden Changes in Temperature

Sudden changes in temperature, such as when entering or leaving a heated building on a cold day, can cause condensation to form inside the device. To prevent condensation, place the device in a carrying case or a plastic bag before exposing it to sudden changes in temperature.

Turn the Product Off Before Removing or Disconnecting the Power Source

Do not remove the battery while the product is on, or while images are being recorded or deleted. Forcibly cutting power in these circumstances could result in loss of data or in damage to product memory or internal circuitry.

 **The Battery**

- Check the battery level when taking the camera out, and charge the battery if necessary (12, 16). Do not continue charging once the battery is fully charged, as this will result in reduced battery performance. If possible, carry a fully-charged spare battery when taking pictures on important occasions.
- Do not use the battery at ambient temperatures below 0 °C (32 °F) or above 40 °C (104 °F).
- Charge the battery indoors with an ambient temperature of 5 °C to 35 °C (41 °F to 95 °F) before use.
 - Charging the battery using the Battery Charger MH-65:
Charge capacity may be reduced at battery temperatures of 0 °C to 10 °C (32 °F to 50 °F) or 45 °C to 60 °C (113 °F to 140 °F).
The battery will not charge if its temperature is below 0 °C (32 °F) or above 60 °C (140 °F).
 - Charging the battery by connecting the AC Adapter EH-63 to the COOLPIX S610c:
Charging time may be increased at battery temperatures of 0 °C to 10 °C (32 °F to 50 °F).
Charge capacity may be reduced at battery temperatures of 45 °C to 60 °C (113 °F to 140 °F).
The battery will not charge if its temperature is below 0 °C (32 °F) or above 60 °C (140 °F).
- Note that the battery may become hot during use; wait for the battery to cool before charging. Failure to observe these precautions could damage the battery, impair its performance or prevent it from charging normally.
- On cold days, the capacity of batteries tends to decrease. Be sure that the battery is fully charged before heading outside to take pictures in cold weather. Keep spare batteries in a warm place and exchange as necessary. Once warmed, a cold battery may recover some of its charge.
- Dirt on the battery terminals can prevent the camera from functioning. Should the battery terminals become dirty, wipe them off with a clean, dry cloth before use.
- When the battery is not in use, remove it from the camera or battery charger and replace the terminal cover. The camera and battery charger draw minute amounts of current even when off; if left in place, the battery could be drained to the point that it no longer functions. Turning the camera on or off while the battery is exhausted can result in reduced battery life.
- Recharge it at least once every six months and run it flat before returning it to storage.
- If the battery will not be used for an extended period, store it in a cool (15 °C to 25 °C / 59 °F to 77 °F), dry place.
- Replace the battery when it no longer holds a charge. Used batteries are a valuable resource. Please recycle used batteries in accordance with local regulations.

Cleaning

Lens	Avoid touching glass parts with your fingers. Remove dust or lint with a blower (typically a small device with a rubber bulb attached to one end that is pumped to produce a stream of air out the other end). To remove fingerprints or other stains that cannot be removed with a blower, wipe the lens with a soft cloth, using a spiral motion that starts at the center of the lens and working toward the edges. If this fails, clean the lens using a cloth lightly dampened with commercial lens cleaner.
Monitor	Remove dust or lint with a blower. To remove fingerprints and other stains, clean the monitor with a soft, dry cloth, being careful not to apply pressure.
Body	Use a blower to remove dust, dirt or sand then wipe gently with a soft, dry cloth. After using the camera at the beach or seaside, wipe off any sand or salt with a dry cloth lightly dampened with fresh water, then dry thoroughly. Note that foreign matter inside the camera could cause damage not covered by the warranty.

Do not use alcohol, thinner, or other volatile chemicals.

Storage

Turn the camera off when not in use. Check that the power-on lamp is off before putting the camera away. Remove the battery if the camera will not be used for an extended period. Do not store the camera with naphtha or camphor moth balls, or in any of the following locations:

- Next to equipment that produces strong electromagnetic fields, such as televisions or radios
- Exposed to temperatures below -10°C (14°F) or above 50°C (122°F)
- Poorly ventilated or subject to humidities of over 60 %

To prevent mold or mildew, take the camera out of storage at least once a month. Turn the camera on and release the shutter a few times before putting the camera away again.

Notes on the Monitor









- The monitor may contain a few pixels that are always lit or that do not light. This is a characteristic common to all TFT LCD displays, and does not indicate a malfunction. Images recorded using the product will not be affected.
- When framing bright subjects, vertical comet-like streaks that whiten toward either end may appear in the display. This phenomenon, known as “smear,” does not appear in the final photograph and does not indicate a malfunction. Some smear may appear in movies.
- Images in the monitor may be difficult to see under bright lighting.
- The monitor is lit by an LED backlight. Should the monitor begin to dim or flicker, contact your Nikon-authorized service representative.

Error Messages











The following table lists the error messages and other warnings displayed in the monitor, as well as the solutions for dealing with them.













For Users of the COOLPIX S610c

See the *Wireless LAN Connection Guide* for error messages that may be displayed with use of the wireless LAN feature.

















Display	Problem	Solution	
 (blinks)	Clock not set.	Set clock.	104
	Battery running low.	Prepare to charge or change battery.	12, 16
 Battery exhausted.	Battery exhausted.	Charge or change battery.	12, 16
 Battery temperature high	Battery temperature is high.	Turn off camera, and allow battery to cool down before resuming use. After five seconds, this message will disappear, the monitor will turn off, and the power-on lamp will blink rapidly. After the lamp blinks for three minutes, the camera will turn off automatically, but you can also press the power switch to turn it off manually.	15
 ● (● blinks red)	Camera cannot focus.	Refocus.	26, 27
 Please wait for the camera to finish recording.	Camera cannot perform other operations until recording is complete.	Wait until message clears from display automatically when recording is complete.	27
 Memory card is write protected.	Write-protect switch is in "lock" position.	Slide write-protect to "write" position.	21

Error Messages

Display	Problem	Solution	
 This card cannot be used.	Error accessing memory card.	<ul style="list-style-type: none"> • Use approved card. • Check that connectors are clean. • Confirm that memory card is correctly inserted. 	116 20
 This card cannot be read.			20
 Card is not formatted. Format card? No Yes	Memory card has not been formatted for use in this camera.	Choose Yes and press  to format card, or turn camera off and replace card.	21
 Out of memory.	Memory card is full.	<ul style="list-style-type: none"> • Choose smaller image size. • Delete pictures or sound files. • Insert new memory card. • Remove memory card and use internal memory. 	83 28, 63, 67 20 21
 Image cannot be saved.	Error occurred while recording picture.	Format internal memory or memory card.	112
	Camera has run out of file numbers.	<ul style="list-style-type: none"> • Insert new memory card. • Format internal memory or memory card. 	20 112
	Picture cannot be used for welcome screen.	Choose a picture taken at any image mode setting other than  16:9 (3584) and  16:9 (1920) , or a small picture or cropped copy of 640x480 pixels or larger.	55, 56, 83
	There is insufficient space to save a copy.	Delete pictures from destination.	98
 Sound file cannot be saved.	Camera has run out of file numbers.	<ul style="list-style-type: none"> • Insert new memory card. • Format internal memory or memory card. 	20 112

Display	Problem	Solution	
 Image cannot be modified.	Cannot edit selected picture.	<ul style="list-style-type: none"> Select picture that supports D-Lighting, crop, or small picture. Movies cannot be edited. 	53 –
 Cannot record movie.	Time out error while recording movie.	Choose memory card with faster write speed.	116
 Memory contains no images.	<ul style="list-style-type: none"> No pictures or sound file in the internal memory or memory card. Memory card does not contain pictures or sound file. 	<p>–</p> <p>To copy picture or sound file from internal memory to memory card, press the MENU button. The copy option screen or copy sound file screen will be displayed.</p>	– 100, 68
 No sound file.			
 File contains no image data.	File not created with this camera.	View file on computer or other device.	–
 This file cannot be played back.			
 All images are hidden.	Date and time are not set for pictures to be displayed by list by date mode.	–	–
 This image cannot be deleted.	Picture is protected.	Disable protection.	98
 Travel destination is in the current time zone.	Destination in same time zone as home.	–	106
Lens error 	Lens error.	Turn camera off and then on again. If error persists, contact retailer or Nikon representative.	22
 Communications error	USB cable disconnected during printing.	Turn camera off and reconnect cable.	75

Error Messages

Display	Problem	Solution	
System error 	Error has occurred in camera's internal circuitry.	Turn camera off, remove and reinsert battery, and turn camera on. If error persists, contact retailer or Nikon representative.	14, 22
 Printer error: Check printer status.	Running out of ink or printer error.	Check printer. After checking the ink or solving the problem, select Resume and press the  button to resume printing.*	-
 Printer error: check paper	Specified size of paper is not loaded in printer.	Load the specified paper, select Resume , and press the  button to resume printing.*	-
 Printer error: paper jam	Paper has jammed in the printer.	Eject the jammed paper, select Resume , and press the  button to resume printing.*	-
 Printer error: out of paper	No paper is loaded in printer.	Load the specified paper, select Resume , and press the  button to resume printing.*	-
 Printer error: check ink	Ink error.	Check ink, select Resume , and press the  button to resume printing.*	-
 Printer error: out of ink	Ink cartridge is empty.	Replace ink, select Resume , and press the  button to resume printing.*	-
 Printer error: file corrupt	An error caused by the image file has occurred.	Select Cancel and press the  button to cancel printing.	-

* See the documentation provided with your printer for further guidance and information.

Troubleshooting

If the camera fails to function as expected, check the list of common problems below before consulting your retailer or Nikon representative. Refer to the page numbers in the right-most column for more information.

For Users of the COOLPIX S610c

See the *Wireless LAN Connection Guide* for information on troubleshooting wireless LAN problems.

Display, Settings and Power Supply



Problem	Cause/Solution	
Monitor is blank	• Camera is off.	22
	• Battery is exhausted.	22
	• Standby mode for saving power: press the shutter-release button halfway.	15, 27
	• When flash lamp blinks red, wait until flash has charged.	31
	• Camera and computer are connected via USB cable.	70
	• Camera and TV are connected via audio/video cable.	69
Monitor is hard to read	• Adjust monitor brightness.	107
	• Monitor is dirty. Clean monitor.	120
	• Monitor has dimmed to save power. Monitor brightens when controls are used.	15
	• Use monitor brightness boost.	23
Camera turns off without warning	• Battery is low.	22
	• Camera has turned off automatically to save power.	112
	• Battery is cold.	119
Date and time of recording are not correct	• Pictures recorded before clock has been set, and "Date not set" indicator blinks during shooting, will have time stamp of "00/00/0000 00:00"; movies and voice recordings will be dated "01/01/2008 00:00."	18
	• Check camera clock regularly against more accurate timepieces and reset as required.	104
No indicators displayed in monitor	Hide info is selected for Photo info . Select Show info .	107





Problem	Cause/Solution	
Date imprint not available	Camera clock has not been set.	18, 104
Date not appearing on pictures even when Date imprint is enabled	The date is not imprinted on movies or on pictures taken in Panorama assist scene mode.	61, 108
Camera settings reset	Backup battery is exhausted; all settings were restored to their default values.	105
Monitor turns off, and the power-on lamp blinks rapidly.	Battery temperature is high. Turn off camera, and allow battery to cool down before resuming use. After the lamp blinks for three minutes, the camera will turn off automatically, but you can also press the power switch to turn it off manually.	15

Electronically Controlled Cameras





In extremely rare instances, unusual characters may appear in the monitor and the camera may stop functioning. In most cases, this phenomenon is caused by a strong external static charge. Turn the camera off, remove and replace the battery, and then turn the camera on again. In the event of continued malfunction, contact your retailer or Nikon representative. Note that disconnecting the power source as described above may result in the loss of any data not recorded to internal memory or the memory card at the time the problem occurred. Data already recorded will not be affected.

Shooting

Problem	Cause/Solution	
No picture taken when shutter-release button is pressed	• When camera is in playback mode, press the  button.	28
	• When menus are displayed, press the MENU button.	11
	• Battery is exhausted.	22
	• When flash lamp blinks, flash is charging.	31
Camera cannot focus	• The intended subject is one with which autofocus does not perform well.	27
	• Set AF assist in the setup menu to Auto .	110
	• Focus error. Turn camera off and then on again.	15

Problem	Cause/Solution	
Pictures are blurred	<ul style="list-style-type: none"> • Use flash. • Use vibration reduction or motion detection. • Use BSS. • Use tripod and self-timer. 	30 109, 110 88 32
Bright specks appear in pictures taken with flash	Flash is reflecting off particles in air. Turn flash off.	31
Flash does not fire	<ul style="list-style-type: none"> • Flash is off. • Some scene modes that cannot turn on flash are selected. •  mode is selected. • Continuous or BSS is selected for Continuous in shooting menu. 	30 35 61 88
Optical zoom cannot be used	Optical zoom cannot be used while recording movies.	61
Digital zoom cannot be used	<ul style="list-style-type: none"> • Digital zoom is set to Off in the setup menu. • Digital zoom is not available in the following situations: <ul style="list-style-type: none"> - when shooting in Portrait or Night portrait scene mode - when shooting in scene auto selector mode - when shooting in active child mode - when shooting in smile mode - before movie recording begins 	111 36, 37 45 47 49 61
No sound when the shutter is released	<ul style="list-style-type: none"> • Off is selected for Sound settings>Shutter sound in setup menu. • Continuous or BSS is selected for Continuous in shooting menu. •  (Sports scene mode) or  (Museum scene mode) is selected. •  mode is selected. • The speaker is obstructed. 	111 88 36, 39 61 4, 24
AF-assist illuminator does not light	<ul style="list-style-type: none"> • Off is selected for AF assist option in camera setup menu. • AF-assist illuminator turns off automatically in some modes. 	110 36-40
Pictures appear smeared	Lens is dirty. Clean lens.	120
Colors are unnatural	White balance does not match light source.	85

Troubleshooting

Problem	Cause/Solution	
Randomly spaced bright pixels ("noise") appear in image	Shutter speed too slow or ISO sensitivity is high. Noise can be reduced by: <ul style="list-style-type: none"> • Using flash • Specifying a lower ISO sensitivity setting • Using a scene mode which has noise reduction ability 	30 89 36
Pictures are too dark (underexposed)	<ul style="list-style-type: none"> • Flash is off. • Flash window is blocked. • Subject is beyond flash range. • Adjust exposure compensation. • Raise the ISO sensitivity. • Subject is backlit. Select  (Backlight scene mode) or use fill flash. 	30 24 30 34 89 30, 40
Pictures are too bright (overexposed)	Adjust exposure compensation.	34
Unexpected results when flash mode is set to  (auto with red-eye reduction)	When  (auto with red-eye reduction) or "fill flash with slow sync and red-eye reduction" of the Night portrait scene mode is applied during shooting, In-Camera Red-Eye Fix may, in very rare cases, be applied to areas not affected by red-eye. Set a flash mode other than  (auto with red-eye reduction) and select a scene mode other than Night portrait , then shoot.	30, 37

Playback

Problem	Cause/Solution	
File cannot be played back	File has been overwritten or renamed by computer or another make or model of camera.	–
Cannot zoom in on picture	Playback zoom cannot be used with movies, small pictures, or cropped copies smaller than 320 × 240 pixels.	–
Cannot record voice memo	<ul style="list-style-type: none"> • Voice memos cannot be appended to movies. • Voice memos cannot be appended to pictures taken by other cameras, and voice memos attached to the images using other cameras cannot be played back. 	63 57

Problem	Cause/Solution	
Cannot use D-Lighting, crop, or small picture options	<ul style="list-style-type: none"> • These options cannot be used with movies. • Choose a picture taken at any image mode setting other than  16:9 (3584) and  16:9 (1920). • Select picture that supports D-Lighting, crop, or small picture. • Pictures taken with another make or model of camera cannot be edited. • Other cameras may be unable to play back, or transfer to a computer, pictures edited with this camera. 	63 83 53 53 53
Pictures not displayed on television	<ul style="list-style-type: none"> • Choose correct video mode. • Memory card contains no pictures. Replace memory card. Remove memory card to play back pictures from internal memory. 	113 20
Nikon Transfer does not start when camera is connected	<ul style="list-style-type: none"> • Camera is off. • Battery is exhausted. • USB cable is not correctly connected. • If your computer is running Windows 2000 Professional, camera cannot be connected to the computer. • Camera is not recognized by the computer. • Computer is not set to launch Nikon Transfer automatically. <p>For more information on Nikon Transfer, refer to help information contained in Nikon Transfer.</p>	22 22 70 70 – –
Pictures to be printed are not displayed	Memory card contains no pictures. Replace memory card. Remove memory card to print pictures from internal memory.	20
Cannot select paper size with camera	Paper size cannot be selected from the camera if the printer does not support the paper sizes used by the camera or the printer automatically selects the page size. Use the printer to select page size.	76, 77

Specifications

Nikon COOLPIX S610/S610c Digital Camera

Type	Compact digital camera
Effective pixels	10.0 million
Image sensor	¹ /2.33-in. CCD; total pixels: approx. 10.34 million
Lens	4x optical zoom, NIKKOR lens
Focal length	5-20mm (equivalent with 35mm [135] format picture angle: 28-112mm)
f/-number	f/2.7-5.8
Construction	7 elements in 6 groups
Digital zoom	Up to 4x (equivalent with 35mm [135] format picture angle: approx. 448mm)
Vibration reduction	Lens shift
Autofocus (AF)	Contrast-detect AF
Focus range (from lens)	<ul style="list-style-type: none">• [W]: 50 cm (1 ft. 8 in.) to ∞ [T]: 60 cm (2 ft.) to ∞• Macro mode: 3 cm (1.2 in.) to ∞(when the zoom indicator is before )
Focus-area selection	Auto (9-area automatic selection), face priority, manual with 99 focus areas, center
Monitor	3-in., Approx. 230k-dot, TFT LCD with anti-reflection coating and 5-level brightness adjustment (equipped with monitor brightness boost function)
Frame coverage (shooting mode)	Approx. 100 % horizontal and 100 % vertical
Frame coverage (playback mode)	Approx. 100 % horizontal and 100 % vertical
Storage	
Media	<ul style="list-style-type: none">• Internal memory (approx. 45 MB)• SD (Secure Digital) memory cards
File system	DCF, Exif 2.2, and DPOF compliant
File formats	Compressed: JPEG-Baseline compliant Movies: AVI Sound files: WAV
Image size (pixels)	<ul style="list-style-type: none">• 3,648 × 2,736 High (3648★)/Normal (3648)• 3,072 × 2,304 Normal (3072)• 2,592 × 1,944 Normal (2592)• 2,048 × 1,536 Normal (2048)• 1,024 × 768 PC screen (1024)• 640 × 480 TV screen (640)• 3,584 × 2,016 16:9 (3584)• 1,920 × 1,080 16:9 (1920)
ISO sensitivity (Standard output sensitivity)	ISO 100, 200, 400, 800, 1600, 3200 Auto (auto gain from ISO 100 to 1600)

Exposure	
Metering	224-segment matrix, center-weighted
Exposure control	Programmed auto exposure with motion detection and exposure compensation (-2.0 to +2.0 EV in steps of $\frac{1}{3}$ EV)
Range (ISO 100)	[W]: -1.0 to +15.5 EV [T]: 1.2 to 17.7 EV
Shutter	Mechanical and charge-coupled electronic shutter
Speed	$\frac{1}{1500}$ –1 s, 4 s (Fireworks show scene mode)
Aperture	Electronically-controlled ND filter (-2 AV) selection
Range	2 steps (f/2.7 and f/5.4 [W])
Self-timer	Can be selected from 10 and 2 seconds duration
Built-in flash	
Range (approx.) (ISO sensitivity: Auto)	[W]: 0.5 to 8.0 m (1.6 to 26.2 ft.) [T]: 0.5 to 3.5 m (1.6 to 11.4 ft.)
Flash control	TTL auto flash with monitor preflashes
Interface	Hi-Speed USB
Data transfer protocol	MTP, PTP
Video output	Can be selected from NTSC and PAL
I/O terminal	Multi connector
Supported languages	Arabic, Chinese (Simplified and Traditional), Czech, Danish, Dutch, English, Finnish, French, German, Greek, Hungarian, Indonesian, Italian, Japanese, Korean, Norwegian, Polish, Portuguese, Russian, Spanish, Swedish, Thai, Turkish
Power sources	<ul style="list-style-type: none"> • One EN-EL12 Rechargeable Li-ion Battery (supplied) • AC Adapter EH-63
Battery life*	Approx. 290 shots (EN-EL12)
Dimensions (W × H × D)	COOLPIX S610: Approx. 94 × 57 × 22.5 mm (3.7 × 2.2 × 0.9 in.) (excluding projections) COOLPIX S610c: Approx. 96.5 × 57 × 22.5 mm (3.8 × 2.2 × 0.9 in.) (excluding projections)
Weight	COOLPIX S610: Approx. 125 g (4.4 oz) (without battery and SD memory card) COOLPIX S610c: Approx. 130 g (4.6 oz) (without battery and SD memory card)
Operating environment	
Temperature	0 to 40 °C (32 to 104 °F)
Humidity	Less than 85 % (no condensation)

Specifications

Wireless (COOLPIX S610c only)	
Standards	IEEE 802.11b/g (standard wireless LAN protocol), ARIB STD-T66 (standard for low power data communications systems)
Communications protocols	IEEE 802.11g: OFDM IEEE 802.11b: DSSS
Operating frequency	2412–2462 MHz (11 channels)
Data rates	IEEE 802.11g: 6, 9, 12, 18, 24, 36, 48, and 54 Mbps IEEE 802.11b: 1, 2, 5.5, and 11 Mbps
Security	TKIP, 128/64-bit (104/40-bit) WEP, AES
Access protocols	Infrastructure

- Unless otherwise stated, all figures are for a camera with a fully-charged Rechargeable Li-ion Battery EN-EL12 operated at an ambient temperature of 25 °C (77 °F).

* Based on Camera and Imaging Products Association (CIPA) standards for measuring the life of camera batteries. Measured at 23 °C (73 °F); zoom adjusted with each shot, flash fired with every other shot, image mode set to  **Normal (3648)**. Battery life may vary depending on shooting interval and length of time menus and images are displayed.

Rechargeable Li-ion Battery EN-EL12

Type	Rechargeable lithium-ion battery
Rated capacity	DC 3.7 V, 1050 mAh
Operating temperature	0 to 40 °C (32 to 104 °F)
Dimensions (W × H × D)	Approx. 32 × 43.8 × 7.9 mm (1.3 × 1.7 × 0.3 in.)
Weight	Approx. 22.5 g (0.8 oz) (excluding terminal cover)

Battery Charger MH-65 (supplied with the COOLPIX S610)

Rated input	AC 100-240 V, 50/60 Hz, 0.08-0.05 A
Rated capacity	8–12 VA
Rated output	DC 4.2 V, 0.7 A
Supported batteries	Nikon Rechargeable Li-ion Battery EN-EL12
Charging time	Approx. 150 minutes when battery is fully discharged
Operating temperature	0 to 40 °C (32 to 104 °F)
Dimensions (W × H × D)	Approx. 58 × 27.5 × 80 mm (2.3 × 1.1 × 3.1 in.) (excluding projections)
Length of power cable	Approx. 1.8 m (6 ft.)
Weight	Approx. 70 g (2.5 oz) (excluding power cable)

AC Adapter EH-63 (supplied with the COOLPIX S610c)

Rated input	AC 100–240 V, 50/60 Hz, 0.18–0.1 A
Rated capacity	18–22 VA
Rated output	DC 4.8 V, 1.5 A
Operating temperature	0 to 40 °C (32 to 104 °F)
Dimensions (W × H × D)	Approx. 41 × 23.5 × 79 mm (1.6 × 0.9 × 3.1 in.) (excluding projections)
Length of connection cord	Approx. 1.7 m (5 ft. 7 in.)
Length of power cable	Approx. 1.8 m (6 ft.)
Weight	Approx. 110 g (3.9 oz) (excluding power cable)

✓ Specifications























Nikon will not be held liable for any errors this manual may contain. The appearance of this product and its specifications are subject to change without notice.

Supported Standards

- **DCF:** Design Rule for Camera File System is a standard widely used in the digital camera industry to ensure compatibility among different makes of camera.
- **DPOF:** Digital Print Order Format is an industry-wide standard that allows pictures to be printed from print orders stored on the memory card.
- **Exif version 2.2:** This camera supports Exif (Exchangeable Image File Format for Digital Still Cameras) version 2.2, a standard that allows information stored with photographs to be used for optimal color reproduction when images are output from Exif-compliant printers.
- **PictBridge:** A standard developed cooperatively by the digital camera and printer industries, allowing photographs to be output directly to a printer without connecting the camera to a computer.
- **Wi-Fi Protected Setup (WPS):** A standard that simplifies home connection and security of wireless devices.

Index

Symbols

-  (auto) mode 22
-  Smile mode 49
-  Active child mode 47
-  Scene mode 35
-  Scene auto selector 45
-  Voice recording mode 64
-  Sound file playback mode 66
-  Movie mode 61
-  Setup mode 101
-  List by date mode 58
- T** (tele) 24
- W** (wide) 24
-  Playback zoom 52
-  Thumbnail playback 51
-  Help 11
-  (apply selection) button 5, 9
-  (delete) button 5, 28, 29, 57, 63
-  (shooting/playback) button 5, 8, 28
-  Self-timer 9, 32
-  Flash mode 9, 30
-  Macro mode 9, 33
- MENU** (menu) button 5, 11
- MODE** (mode) button 5, 8
-  (exposure compensation) 34
-  AE/AF-L 44
-  D-Lighting 54

A



- Accessories 116
- Active child 39
- AF area 26
- AF area mode 90
- AF assist 110
- Audio/video cable 69
- Auto off 112
- Auto-focus mode 62
- AVI 117
- AV-out connect 69

B

- Backlight  40
- Backlit subjects 30, 40
- Battery 14
- Battery charger 12, 116
- Battery level indicator 121

- Battery-chamber/memory card slot cover 5
- Beach/snow  37
- Best shot selector 39
- Blur 127
- Brightness 107

C

- Cable connector 5, 70, 75
- Center-weighted 87
- Cleaning
 - Body 120
 - Lens 120
 - Monitor 120
- Close-up  39
- Color options 89, 94
- Computer 70–73, 113
 - copying pictures to 70–73
- Continuous 88
- Copy 100
- Copy  40
- Crop 55
- Cyanotype 89

D

- Date 18–19, 104, 108
 - printing 81
- Date imprint 108
- Daylight saving time 104
- Delete 98
- Digital print order format 80–81
- Digital zoom 111
- D-Lighting 54
- DSCN 117
- Dusk/dawn  38

E

-  Sound file playback mode 66
- E-mail 83
- Error messages 121–124
- Exposure compensation 34
- Extension 117

F

- Face priority 90
 - shooting 92
- File names 117

- Fill flash 30
- Fireworks show (🎆) 40
- Firmware version 115
- Flash 30, 113
 - lamp 5, 31
 - mode 30
- Flash mode 94
- Focus 6, 26
 - area 6, 26
 - face priority 92
- Focus lock 91
- Folder names 117
- Food 🍴 41
- Format 21, 112
- Framing 24
- FSCN 117
- Full-time AF 93
- I**
- Image mode 35, 83
- Internal memory 6–7, 20, 84, 112
 - capacity 84
 - formatting 112
- ISO sensitivity 89
- J**
- JPEG 130
- JPG 117
- L**
- Landscape (🖼️) 36
- Language 18, 113
- Lens 4, 120
- M**
- Macro mode 33
- Matrix 87
- Memory card 6–7, 20, 84, 116
 - approved 116
 - capacity of 84
 - formatting 112
 - Inserting and removing 20
 - slot 20
- Menus 102
- Metering 87
- Monitor 5, 6–7, 22, 107, 120
 - brightness 107
 - indicators in 6–7
- Monitor brightness boost 23
- Monitor settings 107
- Motion detection 110
- Movie menu 62
- Movie mode 61
- Movie options 62
 - small size 62
 - TV movie 62
- Movies 61, 63
 - deleting 63
 - playback 63
 - recording 61
- Museum (🏛️) 39
- N**
- Night landscape (🌃) 38
- Nikon Transfer 70, 71
- P**
- Panorama assist (📷) 41, 43
- Party/indoor (🎉) 37
- Pastel 89
- PictBridge 74–80
- Playback 28, 51–56
 - menu 95–100
 - thumbnail 51
 - zoom 52
- Playback menu 95–100
- Playback-mode selection menu 9
- Power switch 4
- Power-on lamp 4, 22
- Print set 80, 95
- Print size 84
- Protect 98
- R**
- Red-eye reduction 31
- Reset all 113
- Rotary multi selector 5, 9
- Rotate image 99
- S**
- Scene auto selector 45
- Self-timer 32, 94
- Self-timer lamp 4, 32
- Setup menu 101–115

Index

Shooting menu 82–89
Shooting-mode selection menu 8
Shutter-release button 4
Single AF 93
Slide show 97
Small picture 56
Smear 120
Sound settings 111
Sports (🏈) 36
SSCN 117
Strap, Camera 4
Sunset (🌇) 38
Support information 2

I

Television 69
 connecting to 69
Thumbnail playback 51
Time differences 106
Time zone 18–19, 104, 106
Transfer 71
Tripod 5

U

USB cable 70, 71, 75

V

Vibration reduction 109
Video mode 69, 113
Voice memos 57
Voice recordings
 Copying 68
 Making 64
 Playing 66
Volume 63, 67

W

Welcome screen 101
White balance 85, 94
 preset 86

Z

Zoom 24
 buttons 5
 indicator 6
 playback 52



A series of horizontal dashed lines for handwriting practice, starting from the top right and extending across the page.



A series of horizontal dashed lines for handwriting practice, starting from the top right and extending across the page.

Nikon

No reproduction in any form of this manual, in whole or in part (except for brief quotation in critical articles or reviews), may be made without written authorization from NIKON CORPORATION.



NIKON CORPORATION

Fuji Bldg., 2-3 Marunouchi 3-chome,
Chiyoda-ku, Tokyo 100-8331, Japan

© 2008 Nikon Corporation

YP8G01(11)
6MMA8911-01